

TOSHIBA

Leading Innovation >>>

AIR CONDITIONER (SPLIT TYPE)
Owner's Manual



1114119601

Indoor Unit

Model name:

For commercial use

4-way Cassette Type

RAV-SM564UTP-E

RAV-SM804UTP-E

RAV-SM1104UTP-E

RAV-SM1404UTP-E

RAV-SM1604UTP-E

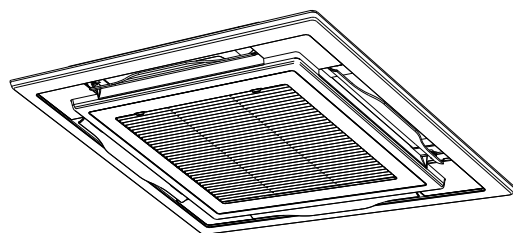

English

Original instruction

ADOPTION OF NEW REFRIGERANT

This Air Conditioner uses R410A an environmentally friendly refrigerant.

This appliance is not intended for use by person (including children) with reduced physical, sensory or mental capabilities, or lack of experience and knowledge, unless they have been given supervision or instruction concerning use of the appliance by a person responsible for their safety.

„Maschinenlärminformations-Verordnung - 3. GPSGV, der höchste Schalldruckpegel beträgt 70 dB(A) oder weniger gemäss EN ISO 7779.“

Contents

1	Precautions for safety	3
1	Précautions relatives à la sécurité	6
1	Sicherheitshinweise	9
1	Precauzioni per la sicurezza	12
1	Precauciones de seguridad	15
1	Precauções de segurança	18
1	Voorzorgen voor de veiligheid	21
1	Προφυλάξεις ασφαλείας	24
1	Правила техники безопасности	27
2	Part names	29
3	Wired remote controller	29
4	Correct usage	31
5	Timer operation	32
6	Adjustment of wind direction	32
7	Power saving mode	34
8	Self clean mode	34
9	Advanced settings	35
	How to set up swing type	
	Setting the louver lock	
	Releasing the louver lock	
10	Maintenance	37
11	Troubleshooting	38
12	Operations and performance	39
13	Installation	39
14	Specifications	40

Thank you for purchasing this Toshiba air conditioner.
 Please read carefully through these instructions that contain important information which complies with the "Machinery" Directive (Directive 2006 / 42 / EC), and ensure that you understand them.
 After reading these instructions, be sure to keep them in a safe place together with the Owner's Manual and Installation Manual supplied with your product.





Generic Denomination: Air Conditioner

Definition of Qualified Installer or Qualified Service Person

The air conditioner must be installed, maintained, repaired and removed by a qualified installer or qualified service person. When any of these jobs is to be done, ask a qualified installer or qualified service person to do them for you.
 A qualified installer or qualified service person is an agent who has the qualifications and knowledge described in the table below.

Agent	Qualifications and knowledge which the agent must have
Qualified installer	<ul style="list-style-type: none"> The qualified installer is a person who installs, maintains, relocates and removes the air conditioners made by Toshiba Carrier Corporation. He or she has been trained to install, maintain, relocate and remove the air conditioners made by Toshiba Carrier Corporation or, alternatively, he or she has been instructed in such operations by an individual or individuals who have been trained and is thus thoroughly acquainted with the knowledge related to these operations. The qualified installer who is allowed to do the electrical work involved in installation, relocation and removal has the qualifications pertaining to this electrical work as stipulated by the local laws and regulations, and he or she is a person who has been trained in matters relating to electrical work on the air conditioners made by Toshiba Carrier Corporation or, alternatively, he or she has been instructed in such matters by an individual or individuals who have been trained and is thus thoroughly acquainted with the knowledge related to this work. The qualified installer who is allowed to do the refrigerant handling and piping work involved in installation, relocation and removal has the qualifications pertaining to this refrigerant handling and piping work as stipulated by the local laws and regulations, and he or she is a person who has been trained in matters relating to refrigerant handling and piping work on the air conditioners made by Toshiba Carrier Corporation or, alternatively, he or she has been instructed in such matters by an individual or individuals who have been trained and is thus thoroughly acquainted with the knowledge related to this work. The qualified installer who is allowed to work at heights has been trained in matters relating to working at heights with the air conditioners made by Toshiba Carrier Corporation or, alternatively, he or she has been instructed in such matters by an individual or individuals who have been trained and is thus thoroughly acquainted with the knowledge related to this work.
Qualified service person	<ul style="list-style-type: none"> The qualified service person is a person who installs, repairs, maintains, relocates and removes the air conditioners made by Toshiba Carrier Corporation. He or she has been trained to install, repair, maintain, relocate and remove the air conditioners made by Toshiba Carrier Corporation or, alternatively, he or she has been instructed in such operations by an individual or individuals who have been trained and is thus thoroughly acquainted with the knowledge related to these operations. The qualified service person who is allowed to do the electrical work involved in installation, repair, relocation and removal has the qualifications pertaining to this electrical work as stipulated by the local laws and regulations, and he or she is a person who has been trained in matters relating to electrical work on the air conditioners made by Toshiba Carrier Corporation or, alternatively, he or she has been instructed in such matters by an individual or individuals who have been trained and is thus thoroughly acquainted with the knowledge related to this work. The qualified service person who is allowed to do the refrigerant handling and piping work involved in installation, repair, relocation and removal has the qualifications pertaining to this refrigerant handling and piping work as stipulated by the local laws and regulations, and he or she is a person who has been trained in matters relating to refrigerant handling and piping work on the air conditioners made by Toshiba Carrier Corporation or, alternatively, he or she has been instructed in such matters by an individual or individuals who have been trained and is thus thoroughly acquainted with the knowledge related to this work. The qualified service person who is allowed to work at heights has been trained in matters relating to working at heights with the air conditioners made by Toshiba Carrier Corporation or, alternatively, he or she has been instructed in such matters by an individual or individuals who have been trained and is thus thoroughly acquainted with the knowledge related to this work.

Warning indications on the air conditioner unit

Warning indication	Description		
 <table border="1"> <tr> <td>WARNING</td> </tr> <tr> <td>ELECTRICAL SHOCK HAZARD Disconnect all remote electric power supplies before servicing.</td> </tr> </table>	WARNING	ELECTRICAL SHOCK HAZARD Disconnect all remote electric power supplies before servicing.	<p>WARNING</p> <p>ELECTRICAL SHOCK HAZARD Disconnect all remote electric power supplies before servicing.</p>
WARNING			
ELECTRICAL SHOCK HAZARD Disconnect all remote electric power supplies before servicing.			
 <table border="1"> <tr> <td>WARNING</td> </tr> <tr> <td>Moving parts. Do not operate unit with grille removed. Stop the unit before the servicing.</td> </tr> </table>	WARNING	Moving parts. Do not operate unit with grille removed. Stop the unit before the servicing.	<p>WARNING</p> <p>Moving parts. Do not operate unit with grille removed. Stop the unit before the servicing.</p>
WARNING			
Moving parts. Do not operate unit with grille removed. Stop the unit before the servicing.			
 <table border="1"> <tr> <td>CAUTION</td> </tr> <tr> <td>High temperature parts. You might get burned when removing this panel.</td> </tr> </table>	CAUTION	High temperature parts. You might get burned when removing this panel.	<p>CAUTION</p> <p>High temperature parts. You might get burned when removing this panel.</p>
CAUTION			
High temperature parts. You might get burned when removing this panel.			
 <table border="1"> <tr> <td>CAUTION</td> </tr> <tr> <td>Do not touch the aluminum fins of the unit. Doing so may result in injury.</td> </tr> </table>	CAUTION	Do not touch the aluminum fins of the unit. Doing so may result in injury.	<p>CAUTION</p> <p>Do not touch the aluminum fins of the unit. Doing so may result in injury.</p>
CAUTION			
Do not touch the aluminum fins of the unit. Doing so may result in injury.			
 <table border="1"> <tr> <td>CAUTION</td> </tr> <tr> <td>BURST HAZARD Open the service valves before the operation, otherwise there might be the burst.</td> </tr> </table>	CAUTION	BURST HAZARD Open the service valves before the operation, otherwise there might be the burst.	<p>CAUTION</p> <p>BURST HAZARD Open the service valves before the operation, otherwise there might be the burst.</p>
CAUTION			
BURST HAZARD Open the service valves before the operation, otherwise there might be the burst.			

1 Precautions for safety

The manufacturer shall not assume any liability for the damage caused by not observing the description of this manual.

WARNING

General

- Carefully read Owner's Manual before starting the air conditioner. There are many important things to keep in mind for daily operation.
- Ask for installation to be performed by the dealer or a professional. Only a qualified installer (*1) is able to install an air conditioner. If a non-qualified person installs an air conditioner, it may result in problems such as fire, electric shock, injury, water leakage, noise and vibration.
- Do not use any refrigerant different from the one specified for complement or replacement. Otherwise, abnormally high pressure may be generated in the refrigeration cycle, which may result in a failure or explosion of the product or an injury to your body.
- Places where the operation sound of the outdoor unit may cause a disturbance. (Especially at the boundary line with a neighbour, install the air conditioner while considering the noise.)

Transportation and storage

- To transport the air conditioner, wear shoes with protective toe caps, protective gloves, and other protective clothing.
- To transport the air conditioner, do not take hold of the bands around the packing carton. You may injure yourself if the bands should break.
- Before stacking the packing cartons for storage or transportation, heed the precautions written on the packing cartons. Failure to heed the precautions may cause the stack to collapse.
- The air conditioner must be transported in stable condition. If any part of the product broken, contact your dealer.
- When the air conditioner must be transported by hand, carry it by two or more people.

Installation

- Only a qualified installer(*1) or qualified service person(*1) is allowed to carry out the electrical work of the air conditioner. Under no circumstances must this work be done by an unqualified individual since failure to carry out the work properly may result in electric shocks and/or electrical leaks.
- After the installation work has been completed, have the installer explain about the circuit breaker positions. In the event that trouble has occurred in the air conditioner, set the circuit breaker to the OFF position, and contact a service person.
- If the unit is installed in a small room, take appropriate measures to prevent the refrigerant from exceeding the limit concentration even if it leaks. Consult the dealer from whom you purchased the air conditioner when you implement the measures. Accumulation of highly concentrated refrigerant may cause an oxygen deficiency accident.
- Do not install the air conditioner in a location that may be subject to a risk of expire to a combustible gas. If a combustible gas leaks and becomes concentrated around the unit, a fire may occur.
- Use the company-specified products for the separately purchased parts. Use of non-specified products may result in fire, electric shock, water leakage or other trouble. Have the installation performed by a professional.
- Confirm that earthing is performed correctly.

Operation

- Before opening the intake grille of the indoor unit or service panel of the outdoor unit, set the circuit breaker to the OFF position. Failure to set the circuit breaker to the OFF position may result in electric shocks through contact with the interior parts. Only a qualified installer(*1) or qualified service person(*1) is allowed to remove the intake grille of the indoor unit or service panel of the outdoor unit and do the work required.
- Inside the air conditioner are high-voltage areas and rotating parts. Due to the danger of electric shocks or of your fingers or physical objects becoming trapped in the rotating parts, do not remove service panel of the outdoor unit. When work involving the removal of these parts is required, contact a qualified installer or a qualified service person.
- Do not move or repair any unit by yourself. Since there is high voltage inside the unit, you may get electric shock when removing the cover and main unit.
- Use of a stand more than 50 cm high to clean the filter of the indoor unit or to carry out other such jobs constitutes working at heights. Due to the danger of falling off the stand and injuring yourself while working at heights, this kind of work should not be done by unqualified individuals. When this kind of work must be carried out, do not do it yourself but ask a qualified installer or a qualified service person to do it for you.
- Do not touch the aluminum fin of the outdoor unit. You may injure yourself if you do so. If the fin must be touched, do not touch it yourself but contact a qualified installer or a qualified service person.
- Do not climb onto or place objects on top of the outdoor unit. You may fall or the objects may fall off of the outdoor unit and result in injury.
- Do not place any combustion appliance in a place where it is directly exposed to the wind of air conditioner, otherwise it may cause imperfect combustion.
- When the air conditioner is operated with a combustion appliance in the same place, ventilate the room sufficiently. Poor ventilation causes oxygen shortage.
- When the air conditioner is used in a closed room, sufficiently ventilate the room. Poor ventilation causes oxygen shortage.
- Do not expose your body to cool air directly for a long time and do not cool yourself excessively. Doing so may result in deteriorated physical condition and ill health.
- Do not insert your finger or a stick into the air intake or discharge. Doing so may result injury as the fan is rotating at high speed inside the unit.
- Consult the shop where you purchased the air conditioner if air conditioning (cooling and heating) is not performed properly as a refrigerant leakage may be the cause. Confirm the repair details with a qualified service person(*1) when the repair includes additional charging of the refrigerant.
- Stop running the air conditioner and turn off the breaker before cleaning. Otherwise, injury may result as the fan is rotating at high speed inside the unit.

Repairs

- If there is any kind of trouble (such as when an error display has appeared, there is a smell of burning, abnormal sounds are heard, the air conditioner fails to cool or heat or water is leaking) has occurred in the air conditioner, do not touch the air conditioner yourself but set the circuit breaker to the OFF position, and contact a qualified service person. Take steps to ensure that the power will not be turned on (by marking "out of service" near the circuit breaker, for instance) until qualified service person arrives. Continuing to use the air conditioner in the trouble status may cause mechanical problems to escalate or result in electric shocks or other trouble.
- If the fan grille is damaged, do not approach the outdoor unit but set the circuit breaker to the OFF position, and contact a qualified service person to have the repairs done. Do not set the circuit breaker to the ON position until the repairs are completed.
- If there is a danger of the indoor unit's falling, do not approach the indoor unit but set the circuit breaker to the OFF position, and contact a qualified installer or a qualified service person to refit the unit. Do not set the circuit breaker to the ON position until the unit has been refitted.
- If there is a danger of the outdoor unit's toppling over, do not approach the outdoor unit but set the circuit breaker to the OFF position, and contact a qualified installer or a qualified service person to have the improvements or refitting done. Do not set the circuit breaker to the ON position until the improvements or refitting is completed.
- Do not customize the unit. Doing so may result in fire, electric shock or other trouble.

Relocation

- When the air conditioner is to be relocated, do not relocate it yourself but contact a qualified installer or a qualified service person. Failure to relocate the air conditioner properly may result in electric shocks and/or a fire.

⚠ CAUTION

To disconnect the appliance from the mains supply.

- This appliance must be connected to the mains by means of a switch with a contact separation of at least 3 mm.

The installation fuse (all types can be used) must be used for the power supply line of this air conditioner.

Installation

- Certainly lay the drain hose for perfect draining. Improper drainage may cause flooding in the house and getting furniture wet.
- Connect the air conditioner to an exclusive power supply of the rated voltage, otherwise the unit may break down or cause a fire.
- Confirm that the outdoor unit are fixed on the base. Otherwise, falling down of the units or other accidents may occur.









Operation

- Do not use this air conditioner for special purpose such as preserving food, precision instruments, art objects, breeding animals, car, vessel.
- Do not touch any switches with wet finger, otherwise you may get an electric shock.
- If the air conditioner will not be used for a considerably long time, turn off the main switch or the circuit breaker, for safety.
- To make the air conditioner operate in its original performance, operate it within the range of the operating temperature specified in the instructions. Otherwise it may cause a malfunction, or water leak from the unit.
- Prevent any liquid from falling into the remote controller. Do not spill juice, water or any kind of liquid.
- Do not wash the air conditioner. Doing so may result in electric shock.
- Check whether the installation base and other equipment have become deteriorated after being used for a long time. Leaving them such condition may result in the unit's falling down and causing injury.
- Do not leave flammable sprays or other flammable materials near the air conditioner, and do not spray flammable aerosol directly to the air conditioner. They may catch fire.
- Stop running the air conditioner and turn off the breaker before cleaning. Otherwise, injury may result as the fan is rotating at high speed inside the unit.
- Ask for cleaning of the air conditioner to be performed by the dealer. Cleaning the air conditioner in an improper manner may cause damage to plastic parts, insulation failure of electric parts or other parts, and result in a malfunction. In the worst case, it may result in water leakage, electric shock, smoke emission or fire.
- Do not put a water container such as a vase on the unit. Water intrusion into the unit may occur and it may cause deterioration of electric insulation and result in electric shock.
- Do not wash air conditioners with pressure washers. Electric leaks may cause electric shocks or fires.

(*1) Refer to the "Definition of Qualified Installer or Qualified Service Person."

■ Information on the transportation, handling and storage of the carton

Examples of indication on the carton

Symbol	Description	Symbol	Description
	Keep dry		Do not drop
	Fragile		Do not lay down
	Stacking height (12 cartons can be stacked in this case)		Do not walk on this carton
	This side up		Do not step
	Handle with care		

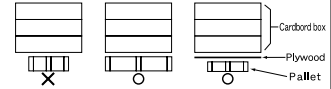
Other cautions	Description
 <p>Caution Injury possibility. Don't handle with packing band, or may get injured in case of broken band.</p>	<p>CAUTION Injury possibility. Don't handle with packing band, or may get injured in case of broken band.</p>
<p>Stacking notice.</p> <p>In case that cardboard boxes protrude out of pallet when stacking, lay a 10mm thick plywood over the pallet.</p> 	<p>Stacking notice. In case that cardboard boxes protrude out of pallet when stacking. Lay a 10 mm thick plywood over the pallet.</p>

Merci d'avoir acheté ce climatiseur Toshiba.

Veillez lire attentivement ces instructions qui contiennent des informations importantes qui sont conformes à la directive « Machines » (Directive 2006/42/EC), et assurez-vous de bien les comprendre.

Après avoir lu ces instructions, veillez à les conserver en lieu sûr avec le Manuel du propriétaire et le Manuel d'installation fournis avec votre produit.

Dénomination générique : Climatiseur





Définition d'un Installateur qualifié ou Technicien d'entretien qualifié

Le climatiseur doit être installé, entretenu, réparé et enlevé par un installateur qualifié ou une personne d'entretien qualifiée. Lorsqu'une de ces opérations doit être effectuée, demandez à un installateur qualifié ou un technicien d'entretien qualifié de les exécuter pour vous.

Un installateur qualifié ou technicien d'entretien qualifié est un agent qui a les qualifications et connaissances décrites dans le tableau ci-dessous.

Agent	Qualifications et connaissances que cet agent doit posséder
Installateur qualifié	<ul style="list-style-type: none"> L'installateur qualifié est une personne qui installe, entretient, déplace et enlève les climatiseurs fabriqués par Toshiba Carrier Corporation. Il ou elle a été formé pour installer, entretenir, déplacer et enlever les climatiseurs fabriqués par Toshiba Carrier Corporation ou, alternativement, il ou elle a reçu des consignes concernant de telles opérations par une ou des personnes qui ont été formés et a, par conséquent, acquis toutes les connaissances associées à ces opérations. L'installateur qualifié qui est autorisé à effectuer un travail électrique compris dans l'installation, le déplacement et l'enlèvement possède les qualifications nécessaires à ce travail électrique conformément aux réglementations et à la législation locales, et il ou elle est une personne qui a été formée pour les problèmes relatifs au travail électrique sur les climatiseurs fabriqués par Toshiba Carrier Corporation ou, alternativement, il ou elle a reçu des consignes dans de tels domaines par une ou des personnes qui ont été formées et possèdent, par conséquent, les connaissances relatives à ce travail. L'installateur qualifié qui est autorisé à manipuler du fluide frigorigène et à réaliser un travail de raccordement compris dans l'installation, le déplacement et l'enlèvement possède les qualifications nécessaires à cette manipulation de fluide frigorigène et de ce travail de raccordement conformément aux réglementations et à la législation locales, et il ou elle est une personne qui a été formée pour les problèmes relatifs à la manipulation de fluide frigorigène et de travail de raccordement sur les climatiseurs fabriqués par Toshiba Carrier Corporation ou, alternativement, il ou elle a reçu des consignes dans de tels domaines par une ou des personnes qui ont été formées et possèdent, par conséquent, les connaissances relatives à ce travail. L'installateur qualifié qui est autorisé à travailler en hauteur a été formé aux domaines relatifs au travail en hauteur avec les climatiseurs fabriqués par Toshiba Carrier Corporation ou, alternativement, il ou elle a reçu des consignes dans de tels domaines par une ou des personnes qui ont été formées et possèdent, par conséquent, toutes les connaissances requises pour ce travail.
Technicien d'entretien qualifié	<ul style="list-style-type: none"> La personne d'entretien qualifiée est une personne qui installe, répare, entretient, déplace et enlève les climatiseurs fabriqués par Toshiba Carrier Corporation. Il ou elle a été formé pour installer, réparer, entretenir, déplacer et enlever les climatiseurs fabriqués par Toshiba Carrier Corporation ou, alternativement, il ou elle a reçu des consignes pour de telles opérations par une ou des personnes qui ont été formées et a, par conséquent, acquis toutes les connaissances associées à ces opérations. La personne d'entretien qualifiée qui est autorisée à effectuer un travail électrique compris dans l'installation, la réparation, le déplacement et l'enlèvement possède les qualifications nécessaires à ce travail électrique conformément aux réglementations et à la législation locales, et il ou elle est une personne qui a été formée pour les problèmes relatifs au travail électrique sur les climatiseurs fabriqués par Toshiba Carrier Corporation ou, alternativement, il ou elle a reçu des consignes dans de tels domaines par une ou des personnes qui ont été formées et possèdent, par conséquent, les connaissances relatives à ce travail. La personne d'entretien qualifiée qui est autorisée à manipuler du fluide frigorigène et à réaliser un travail de raccordement compris dans l'installation, la réparation, le déplacement et l'enlèvement possède les qualifications nécessaires à cette manipulation de fluide frigorigène et de ce travail de raccordement conformément aux réglementations et à la législation locales, et il ou elle est une personne qui a été formée pour les problèmes relatifs à la manipulation de fluide frigorigène et de travail de raccordement sur les climatiseurs fabriqués par Toshiba Carrier Corporation ou, alternativement, il ou elle a reçu des consignes dans de tels domaines par une ou des personnes qui ont été formées et possèdent, par conséquent, les connaissances relatives à ce travail. La personne d'entretien qualifiée qui est autorisée à travailler en hauteur a été formé aux domaines relatifs au travail en hauteur avec les climatiseurs fabriqués par Toshiba Carrier Corporation ou, alternativement, il ou elle a reçu des consignes dans de tels domaines par un ou des personnes qui ont été formées et possèdent, par conséquent, toutes les connaissances requises pour ce travail.

■ Avertissements apposés sur le climatiseur

Indication d'avertissement	Description
 <p>WARNING ELECTRICAL SHOCK HAZARD Disconnect all remote electric power supplies before servicing.</p>	<p>AVERTISSEMENT RISQUE DE DECHARGE ELECTRIQUE Débranchez toutes les alimentations électriques distantes avant l'entretien.</p>
 <p>WARNING Moving parts. Do not operate unit with grille removed. Stop the unit before the servicing.</p>	<p>AVERTISSEMENT Pièces mobiles. Ne faites pas fonctionner l'unité avec la grille déposée. Arrêtez l'unité avant l'entretien.</p>
 <p>CAUTION High temperature parts. You might get burned when removing this panel.</p>	<p>PRÉCAUTION Pièces à haute température. Vous pourriez vous brûler en déposant ce panneau.</p>
 <p>CAUTION Do not touch the aluminum fins of the unit. Doing so may result in injury.</p>	<p>PRÉCAUTION Ne touchez pas les ailettes en aluminium de l'unité. Vous pourriez vous blesser.</p>
 <p>CAUTION BURST HAZARD Open the service valves before the operation, otherwise there might be the burst.</p>	<p>PRÉCAUTION RISQUE D'EXPLOSION Ouvrez les soupapes de service avant l'opération, sinon un éclatement pourrait se produire.</p>

1 Précautions relatives à la sécurité

Le fabricant ne peut être tenu responsable pour tout dommage causé par le non respect des instructions et descriptions de ce manuel.

AVERTISSEMENT

Généralités

- Veuillez lire attentivement le manuel du propriétaire avant de mettre le climatiseur en marche. Plusieurs aspects doivent être pris en compte pour son fonctionnement quotidien.
- Demandez à votre revendeur ou à un professionnel de réaliser l'installation. Seul un installateur qualifié (*1) est capable d'installer un climatiseur. Si une personne non qualifiée installe un climatiseur, des problèmes peuvent se produire, tels qu'un incendie, une électrocution, des blessures, une fuite d'eau, du bruit et des vibrations.
- N'utilisez aucun autre réfrigérant que celui spécifié pour tout rajout ou remplacement. Sinon, une haute pression anormale pourrait être générée dans le circuit de réfrigération, qui pourrait entraîner une panne ou une explosion du produit ou même des blessures corporelles.
- Les endroits où de bruit de fonctionnement de l'unité extérieure peut être une nuisance. (En particulier, si le climatiseur doit être installé en limite de propriété, tenez le plus grand compte de sa nuisance sonore.)

Transport et entreposage

- Lors du transport du climatiseur, portez des chaussures à coquilles, des gants et des vêtements de protection supplémentaires.
- Lors du transport du climatiseur, n'agrippez pas les bandes du carton d'emballage. Vous risquez de vous blesser si les bandes se brisent.
- Avant d'empiler les cartons d'emballage pour l'entreposage ou le transport, tenez compte des précautions inscrites sur les cartons d'emballage. Ne pas tenir compte de ces précautions risque d'entraîner l'effondrement de la pile.
- Le climatiseur doit être transporté dans des conditions stables. Si une pièce était endommagée, contactez le revendeur.
- Lorsque le climatiseur doit être déplacé manuellement, prévoyez deux personnes ou plus pour son transport.

Installation

- Seul un installateur qualifié(*1) ou une personne d'entretien qualifiée(*1) est autorisé à réaliser le travail électrique sur le climatiseur. En aucun cas, ce travail doit être effectué par une personne non qualifiée étant donné que si le travail n'est pas correctement effectué, des décharges électriques et/ou des fuites électriques peuvent survenir.
- Une fois l'installation terminée, l'installateur doit expliquer les positions du disjoncteur. Dans l'hypothèse où ce problème est survenu dans ce climatiseur, réglez le disjoncteur sur la position OFF et contactez une personne de l'entretien.
- Si l'unité est installée dans une petite pièce, prenez les mesures qui s'imposent pour qu'en cas de fuite la teneur en réfrigérant ne dépasse pas les limites permises. Consultez le revendeur chez qui vous avez acquis le climatiseur au moment de mettre en pratique ces mesures. Une accumulation de réfrigérant à haute concentration est susceptible de provoquer une insuffisance d'oxygène.
- N'installez pas le climatiseur dans un endroit qui peut être soumis à un risque de gaz combustible. En présence de fuites de gaz combustible ou d'une accumulation de celui-ci autour de l'unité, un incendie peut survenir.
- Utilisez les produits spécifiés par la compagnie pour les pièces achetées séparément. L'utilisation de produits non spécifiés peut entraîner un incendie, une électrocution, une fuite d'eau ou tout autre problème. Faites réaliser l'installation par un professionnel.
- Vérifiez que la mise à la terre est effectuée correctement.

Fonctionnement

- Avant d'ouvrir la grille d'entrée d'air de l'unité intérieure ou du panneau de service de l'unité extérieure, réglez le disjoncteur sur la position OFF. Ne pas régler le disjoncteur sur la position OFF peut donner lieu à des chocs électriques par le biais d'un contact avec les pièces intérieures. Seul un installateur qualifié(*1) ou une personne d'entretien qualifiée(*1) est autorisé à enlever la grille d'entrée d'air de l'unité intérieure ou le panneau de service de l'unité extérieure et à effectuer le travail requis.
- A l'intérieur du climatiseur se trouvent des zones à haute tension et des pièces tournantes. En raison d'un risque de chocs électriques ou du fait que vos doigts ou des objets puissent se coincer dans les pièces tournantes, n'enlevez pas le panneau de service de l'unité extérieure. Lorsque le travail englobant la dépose de ces pièces est requis, contactez un installateur qualifié ou une personne d'entretien qualifiée.
- Ne déplacez ni ne réparez l'unité vous-même. Celle-ci fonctionnant sous haute tension, vous pourriez vous électrocuter en démontant le couvercle et l'unité principale.
- Utilisez un support de plus de 50 cm de haut pour nettoyer le filtre de l'unité intérieure ou pour effectuer d'autres travaux nécessitant un travail en hauteur. Etant donné que le support risque de tomber et de vous blesser lors d'un travail en hauteur, ce genre de travail ne peut pas être réalisé par des personnes non-qualifiées. Lorsque ce type de travail doit être réalisé, ne le faites pas vous-même mais demandez plutôt à un installateur qualifié ou à une personne d'entretien qualifiée de l'effectuer pour vous.
- Ne touchez pas l'ailette en aluminium de l'unité extérieure. Vous risquez de vous blesser dans le cas contraire. Si l'ailette doit être touchée, ne la touchez pas vous-même mais contactez plutôt un installateur qualifié ou une personne d'entretien qualifiée.
- Ne grimpez pas ou ne placez pas d'objets sur le dessus de l'unité extérieure. Vous ou les objets pourraient tomber de l'unité extérieure et ainsi vous blesser.
- Ne placez aucun appareil à combustion dans un endroit exposé directement au souffle du climatiseur, faute de quoi sa combustion risquerait d'être déficiente.
- Si le climatiseur doit fonctionner dans une pièce contenant aussi un appareil à combustion, ventilez la pièce suffisamment. Une ventilation trop faible risquerait de provoquer une insuffisance d'oxygène.
- Quand le climatiseur est utilisé dans un endroit clos, pensez à aérer suffisamment la pièce. Une ventilation trop faible risquerait de provoquer une insuffisance d'oxygène.
- N'exposez pas votre corps directement à l'air froid pendant longtemps et ne vous refroidissez pas excessivement. Cela pourrait détériorer votre condition physique et vous rendre malade.
- N'insérez pas votre doigt ni une tige dans l'admission ou l'évacuation d'air.
- Cela pourrait entraîner des blessures car la rotation du ventilateur se fait à grande vitesse dans l'appareil.
- Consultez le magasin où vous avez acheté le climatiseur si la climatisation (refroidissement et chauffage) n'est pas réalisée correctement car une fuite de réfrigérant pourrait en être la cause. Vérifiez les détails de la réparation avec un personnel de service qualifié(*1) quand la réparation comprend une charge supplémentaire de réfrigérant.
- Arrêtez le fonctionnement du climatiseur et de coupez le disjoncteur avant le nettoyage. Sinon, cela pourrait entraîner des blessures car la rotation du ventilateur se fait à grande vitesse dans l'appareil.

Réparations

- En cas de problème (comme par exemple lorsque l'affichage d'une erreur est apparue, une odeur de brûlé survient, des sons anormaux sont entendus, le climatiseur ne parvient pas à refroidir ou à réchauffer ou une fuite d'eau est présente) est survenu au niveau du climatiseur, ne touchez pas le climatiseur vous-même et réglez le disjoncteur sur la position OFF, ensuite, contactez une personne d'entretien qualifiée. Prenez des mesures pour garantir que l'alimentation ne sera pas branchée (en indiquant « hors service » près du disjoncteur, par exemple) jusqu'à ce que la personne d'entretien qualifiée arrive. Continuer à utiliser le climatiseur alors qu'il présente un problème peut entraîner des problèmes mécaniques ou donner lieu à des chocs électriques et autres pannes.
- Si la grille du ventilateur est endommagée, n'approchez pas de l'unité extérieure et réglez le disjoncteur sur la position OFF, ensuite contactez une personne d'entretien qualifiée pour effectuer les réparations. Ne réglez pas le disjoncteur en position ON jusqu'à ce que les réparations soient terminées.
- S'il existe un danger que l'unité intérieure tombe, ne vous approchez pas de l'unité intérieure et réglez le disjoncteur en position OFF, ensuite contactez un installateur qualifié ou une personne d'entretien qualifiée pour réinstaller l'unité. Ne réglez pas le disjoncteur en position ON jusqu'à ce que l'unité soit réinstallée.
- S'il existe un danger que l'unité extérieure ne se renverse, ne vous approchez pas de l'unité extérieure et réglez le disjoncteur en position OFF, ensuite contactez un installateur qualifié ou une personne d'entretien qualifiée pour réinstaller l'unité ou effectuer les améliorations. Ne réglez pas le disjoncteur en position ON jusqu'à ce que les améliorations ou la réinstallation soient terminées.
- Ne modifiez pas l'appareil. Cela pourrait entraîner un incendie, une électrocution ou un autre problème.

Réinstallation

- Lorsque le climatiseur doit être réinstallé, ne le déplacez pas vous-même mais contactez plutôt un installateur qualifié ou une personne d'entretien qualifiée. Si le climatiseur n'est pas correctement réinstallé, cela peut donner lieu à des décharges électriques et/ou un incendie.

⚠ PRÉCAUTION

Pour déconnecter l'appareil du secteur.

- Cet appareil doit être branché sur secteur au moyen d'un interrupteur avec une séparation de contact d'au moins 3 mm.

Vous devez utiliser un fusible d'installation (tous les types de fusible peuvent être utilisés) pour la ligne d'alimentation de ce climatiseur.

Installation

- Faites cheminer le tuyau de vidange comme il convient pour assurer un écoulement parfait. Une vidange incorrecte peut entraîner l'inondation d'une pièce et des dommages aux meubles.
- Raccordez le climatiseur à une alimentation exclusive correspondant à la tension nominale, faute de quoi l'unité pourrait tomber en panne ou provoquer un incendie.
- Vérifiez que l'unité extérieure est fixée à la base. Sinon, les unités pourraient se renverser ou d'autres accidents pourraient se produire.









Fonctionnement

- N'utilisez pas ce climatiseur à des fins particulières, telles que la conservation d'aliments, d'instruments de précision, d'objets d'art, d'animaux d'élevage, en voiture, bateau.
- Ne touchez aucun interrupteur si vous avez les mains humides, faute de quoi vous risqueriez de vous électrocuter.
- Lorsque vous envisagez de ne pas utiliser l'appareil pendant une période prolongée, désactivez l'interrupteur principal ou le disjoncteur par mesure de sécurité.
- Pour que le climatiseur conserve toute sa puissance, conformez-vous à la gamme des températures de fonctionnement précisée dans les instructions. Dans le cas contraire, il peut présenter une défaillance, tomber en panne ou laisser fuir de l'eau.
- Évitez de faire tomber du liquide dans la télécommande. Évitez de renverser du jus, de l'eau ou tout autre liquide.
- Ne lavez pas le climatiseur. Cela pourrait entraîner une électrocution.
- Vérifiez si la base de l'installation et les autres équipements ont été détériorés après une utilisation pendant une longue période. Les laisser dans une telle condition peut entraîner une chute de l'unité et causer des blessures.
- Ne laissez pas des vaporisateurs inflammables ou d'autres matériaux inflammables près du climatiseur, et ne vaporisez pas un aérosol inflammable directement sur le climatiseur. Ils pourraient prendre feu.
- Arrêtez le fonctionnement du climatiseur et de coupez le disjoncteur avant le nettoyage.
- Pour le nettoyage du climatiseur, demandez qu'il soit réalisé par le revendeur.
- Nettoyer un climatiseur d'une façon incorrecte peut causer des dommages aux pièces en plastique, des défauts d'isolation des pièces électriques ou des autres pièces, et entraîner un mauvais fonctionnement. Dans le pire des cas, cela pourrait entraîner une fuite d'eau, une électrocution, une émission de fumée ou un incendie.
- Ne placez pas de récipient d'eau tel qu'un vase sur l'unité.
- Une pénétration d'eau dans l'appareil pourrait se produire et cela pourrait entraîner une détérioration de l'isolation électrique et une électrocution.
- Ne lavez pas les climatiseurs avec un nettoyeur à haute pression.
- Les fuites électriques risquent de provoquer une électrocution ou un incendie.

(*1) Reportez-vous à « Définition d'un Installateur qualifié ou Technicien d'entretien qualifié ».

■ Informations concernant le transport, la manipulation et l'entreposage du carton

Exemples d'indication sur le carton

Symbole	Description	Symbole	Description
	Gardez au sec		Ne le laissez pas tomber
	Fragile		Ne pas le coucher
	11 cartons		Ne marchez pas sur ce carton
	Cette face vers le haut		Ne pas faire un pas
	Manipuler avec soin		

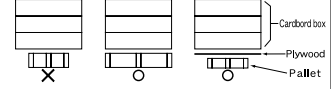
Autres précautions	Description
 Caution Injury possibility. Don't handle with packing band, or may get injured in case of broken band.	PRÉCAUTION Risque de blessure. Ne pas manipuler à l'aide de la bande d'emballage sous peine de se blesser en cas de rupture de bande.
Stacking notice. In case that cardboard boxes protrude out of pallet when stacking, lay a 10mm thick plywood over the pallet. 	Notice concernant l'empilement. Dans le cas où des caisses en carton dépassent de la palette lors de l'empilement. Placez un panneau contreplaqué de 10 mm d'épaisseur sur la palette.

Vielen Dank, dass Sie sich für eine Klimaanlage von Toshiba entschieden haben.
Bitte lesen Sie diese Anleitung, die wichtige Informationen gemäß der „Maschinenrichtlinie“ (Richtlinie 2006/42/EG) enthält, aufmerksam und klären Sie eventuelle Fragen.
Nachdem Sie diese Anweisungen gelesen haben, bewahren Sie sie unbedingt an einem sicheren Ort zusammen mit dem Benutzerhandbuch und dem Ihrem Produkt beiliegenden Installationshandbuch auf.

Allgemeine Bezeichnung: Klimaanlage





Definition der Bezeichnungen Qualifizierter Installateur oder Qualifizierter Servicetechniker

Die Klimaanlage muss von einem qualifizierten Installateur oder einem qualifizierten Servicetechniker installiert, gewartet, repariert und entsorgt werden. Wenn eine dieser Aufgaben erledigt werden muss, bitten Sie einen qualifizierten Installateur oder einen qualifizierten Servicetechniker, diese für Sie auszuführen.

Ein qualifizierter Installateur oder ein qualifizierter Servicetechniker ist ein Auftragnehmer, der über die Qualifikationen und das Fachwissen verfügt, welche in der untenstehenden Tabelle genannt sind.

Auftragnehmer	Qualifikationen und Fachwissen, über welche der Auftragnehmer verfügen muss
Qualifizierter Installateur	<ul style="list-style-type: none"> Der Installationsfachmann ist eine Person, die Klimaanlage der Toshiba Carrier Corporation einbaut, wartet, umzieht und ausbaut. Die Person ist im Einbau und in der Wartung sowie im Umzug und Ausbau von Klimaanlage der Toshiba Carrier Corporation geschult oder wurde von einer geschulten Person oder geschulten Personen unterwiesen und verfügt aufgrund dessen über gründliche Kenntnisse, die sie zur Ausführung dieser Arbeiten befähigen. Der Installationsfachmann, dem es erlaubt ist, Elektroarbeiten im Zuge des Einbaus, Umzugs oder Ausbaus auszuführen, verfügt über die jeweils gesetzlich vorgeschriebene Qualifikation zur Ausführung von Elektroarbeiten und ist eine Person, die im Zusammenhang mit Elektroarbeiten an Klimaanlage der Toshiba Carrier Corporation geschult ist oder in diesem Zusammenhang von einer geschulten Person oder geschulten Personen unterwiesen wurde, so dass sie über gründliche Kenntnisse verfügt, die sie zur Ausführung dieser Arbeiten befähigen. Der Installationsfachmann, dem es erlaubt ist, kältemittel- oder rohrtechnische Arbeiten im Zuge des Einbaus, Umzugs oder Ausbaus auszuführen, verfügt über die jeweils gesetzlich vorgeschriebene Qualifikation zur Ausführung von kältemittel- und rohrtechnischen Arbeiten und ist eine Person, die im Zusammenhang mit kältemittel- und rohrtechnischen Arbeiten an Klimaanlage der Toshiba Carrier Corporation geschult ist oder in diesem Zusammenhang von einer geschulten Person oder geschulten Personen unterwiesen wurde, so dass sie über gründliche Kenntnisse verfügt, die sie zur Ausführung dieser Arbeiten befähigen. Der Installationsfachmann, dem es erlaubt ist, Arbeiten in der Höhe auszuführen, ist im Zusammenhang mit Arbeiten in der Höhe an Klimaanlage der Toshiba Carrier Corporation geschult oder wurde in diesem Zusammenhang von einer geschulten Person oder geschulten Personen unterwiesen und verfügt aufgrund dessen über gründliche Kenntnisse, die ihn zur Ausführung dieser Arbeiten befähigen.
Qualifizierter Servicetechniker	<ul style="list-style-type: none"> Der Kundendienstfachmann ist eine Person, die Klimaanlage der Toshiba Carrier Corporation einbaut, repariert, wartet, umzieht und ausbaut. Die Person ist im Einbau, in der Reparatur und in der Wartung sowie im Umzug und Ausbau von Klimaanlage der Toshiba Carrier Corporation geschult oder wurde von einer geschulten Person oder geschulten Personen unterwiesen und verfügt aufgrund dessen über gründliche Kenntnisse, die sie zur Ausführung dieser Arbeiten befähigen. Der Kundendienstfachmann, dem es erlaubt ist, Elektroarbeiten im Zuge des Einbaus, der Reparatur, des Umzugs oder Ausbaus auszuführen, verfügt über die jeweils gesetzlich vorgeschriebene Qualifikation zur Ausführung von Elektroarbeiten und ist eine Person, die im Zusammenhang mit Elektroarbeiten an Klimaanlage der Toshiba Carrier Corporation geschult ist oder in diesem Zusammenhang von einer geschulten Person oder geschulten Personen unterwiesen wurde, so dass sie über gründliche Kenntnisse verfügt, die sie zur Ausführung dieser Arbeiten befähigen. Der Kundendienstfachmann, dem es erlaubt ist, kältemittel- oder rohrtechnische Arbeiten im Zuge des Einbaus, der Reparatur, des Umzugs oder Ausbaus auszuführen, verfügt über die jeweils gesetzlich vorgeschriebene Qualifikation zur Ausführung von kältemittel- und rohrtechnischen Arbeiten und ist eine Person, die im Zusammenhang mit kältemittel- und rohrtechnischen Arbeiten an Klimaanlage der Toshiba Carrier Corporation geschult ist oder in diesem Zusammenhang von einer geschulten Person oder geschulten Personen unterwiesen wurde, so dass sie über gründliche Kenntnisse verfügt, die sie zur Ausführung dieser Arbeiten befähigen. Der Kundendienstfachmann, dem es erlaubt ist, Arbeiten in der Höhe auszuführen, ist im Zusammenhang mit Arbeiten in der Höhe an Klimaanlage der Toshiba Carrier Corporation geschult oder wurde in diesem Zusammenhang von einer geschulten Person oder geschulten Personen unterwiesen und verfügt aufgrund dessen über gründliche Kenntnisse, die ihn zur Ausführung dieser Arbeiten befähigen.

Warnhinweise an der Klimaanlage

Warnanzeige	Beschreibung
 <p>WARNING ELECTRICAL SHOCK HAZARD Disconnect all remote electric power supplies before servicing.</p>	<p>WARNUNG GEFAHR EINES ELEKTRISCHEN SCHLAGS Trennen Sie alle fernen Stromversorgungsquellen vom Netz, bevor Sie Wartungsarbeiten ausführen.</p>
 <p>WARNING Moving parts. Do not operate unit with grille removed. Stop the unit before the servicing.</p>	<p>WARNUNG Bewegliche Teile. Bedienen Sie nicht das Gerät, wenn das Gitter entfernt wurde. Stoppen Sie das Gerät, bevor Sie es warten.</p>
 <p>CAUTION High temperature parts. You might get burned when removing this panel.</p>	<p>VORSICHT Teile mit hohen Temperaturen. Es besteht die Gefahr, dass Sie sich verbrennen, wenn Sie diese Abdeckung entfernen.</p>
 <p>CAUTION Do not touch the aluminum fins of the unit. Doing so may result in injury.</p>	<p>VORSICHT Berühren Sie nicht die Aluminiumrippen des Geräts. Dies kann zu Verletzungen führen.</p>
 <p>CAUTION BURST HAZARD Open the service valves before the operation, otherwise there might be the burst.</p>	<p>VORSICHT EXPLOSIONSGEFAHR! Öffnen Sie vor dem Arbeitsgang die Versorgungsventile, da es anderenfalls zu einer Explosion kommen kann.</p>

1 Sicherheitshinweise

Der Hersteller haftet nicht für Schäden, die durch ein Missachten der in diesem Handbuch enthaltenen Hinweise verursacht werden.

WARNUNG

Allgemeines

- Lesen Sie bitte die Bedienungsanleitung, bevor Sie die Klimaanlage in Betrieb nehmen. Sie enthält zahlreiche wichtige Hinweise für den täglichen Betrieb.
- Sorgen Sie dafür, dass die Installation vom Fachhändler oder von einem Fachmann durchgeführt wird. Nur ein qualifizierter Installateur (*1) ist in der Lage, eine Klimaanlage zu installieren. Falls eine nicht-qualifizierte Person eine Klimaanlage installiert, kann dies zu Problemen wie einem Brand, einem elektrischen Schlag, Verletzungen, Wasseraustritten, Lärm und Vibrationen führen.
- Verwenden Sie zum Auffüllen oder Austauschen des Kühlmittels ausschließlich das für dieses Gerät spezifizierte Kühlmittel. Bei Missachtung dieses Hinweises können im Kühlkreislauf ungewöhnlich hohe Drücke entstehen, was zum Ausfall oder zur Explosion des Geräts sowie zu Personenschäden führen kann.
- Orte, an denen das Betriebsgeräusch des Außengeräts zu Störungen führen kann. (Installieren Sie die Klimaanlage insbesondere an der Grenze zu einem Ihrer Nachbarn, indem Sie dem Geräuschpegel Rechnung tragen.)

Transport und Lagerung

- Tragen Sie beim Transportieren der Klimaanlage Schuhe mit Zehenschutzkappen, Schutzhandschuhe und andere Schutzbekleidung.
- Benutzen Sie zum Tragen der Klimaanlage nicht die um den Verpackungskarton verlaufenden Bänder. Anderenfalls können Sie sich verletzen, wenn die Bänder reißen.
- Beachten Sie beim Stapeln der Packkartons zur Lagerung oder zum Transport die Sicherheitshinweise auf den Kartons. Es gilt zu verhindern, dass der Stapel zusammenbricht.
- Die Klimaanlage muss in einem stabilen Zustand transportiert werden. Setzen Sie sich mit Ihrem Fachhändler in Verbindung, falls ein bestimmtes Teil des Produkts defekt ist.
- Falls die Klimaanlage von Hand transportiert wird, muss von mindestens zwei Personen getragen werden.

Installation

- Nur ein qualifizierter Installateur(*1) oder ein qualifizierter Servicetechniker(*1) darf Elektroarbeiten an der Klimaanlage ausführen. Unter keinen Umständen dürfen diese Arbeiten von unqualifizierten Mitarbeitern ausgeführt werden, da eine nicht sachgemäße Ausführung der Arbeit zu elektrischen Schlägen und/oder Kriechströmen führen kann.
- Lassen Sie sich nach dem Einbau vom Installateur zeigen, wo sich der Schutzschalter befindet. Falls die Klimaanlage eine Störung zeigt, schalten Sie den Schutzschalter aus und rufen einen Kundendiensttechniker.
- Wenn Sie die Anlage in einem kleinen Raum installieren, ergreifen Sie angemessene Vorsichtsmaßnahmen, damit die Kühlmittelkonzentration auch bei Kühlmittelaustritt den Sicherheitsgrenzwert nicht überschreitet. Wenden Sie sich bei Fragen zur Umsetzung der Maßnahmen an den Händler, bei dem Sie die Klimaanlage gekauft haben. Durch Ansammlung von hochkonzentriertem Kühlmittel kann es zu einem Unfall durch Sauerstoffmangel kommen.
- Installieren Sie die Klimaanlage nicht an Orten, an denen die Gefahr besteht, dass sie brennbaren Gasen ausgesetzt ist. Wenn das brennbare Gas ausströmt und sich im Bereich des Geräts sammelt, kann es sich entzünden.
- Verwenden Sie die vom Hersteller angegebenen Produkte für die separat gekauften Teile. Die Verwendung nicht-spezifizierter Produkte kann Brände, Stromschläge, Wasseraustritte und andere Probleme zur Folge haben. Lassen Sie die Installation von einem Fachmann durchführen.
- Vergewissern Sie sich darüber, dass eine ordnungsgemäße Erdung durchgeführt wird.

Bedienung

- Bevor Sie das Einlassgitter des Innengerätes oder das Wartungspaneel des Außengeräts öffnen, stellen Sie den Schutzschalter auf die Position OFF (aus). Sollten Sie diesen Hinweis nicht beachten, kann es durch Kontakt mit den Innenteilen zu einem Stromschlag kommen. Nur ein qualifizierter Installateur(*1) oder ein qualifizierter Servicetechniker(*1) darf das Einlassgitter des Innengeräts oder das Wartungspaneel des Außengeräts entfernen und die erforderlichen Arbeiten ausführen.
- Im Innern der Klimaanlage liegt an verschiedenen Stellen Hochspannung an, außerdem befinden sich hier drehende Teile. Wegen der Stromschlaggefahr und Verletzungsgefahr soll die Wartungsabdeckung am Außengerät vom Benutzer nicht entfernt werden. Wenn diese Teile aus einem Grund ausgebaut werden müssen, wenden Sie sich an einen Installations- oder Kundendienstfachmann.
- Versuchen Sie unter keinen Umständen, eines der Geräte selbst auszubauen bzw. instand zu setzen. Da das Gerät mit Netzspannung betrieben wird, können Sie bei der Demontage des Deckels und des Hauptgeräts einen elektrischen Schlag bekommen.
- Das Besteigen einer Erhöhung, die höher als 50 cm ist, zum Zweck der Reinigung des Innengerätfilters fällt unter so genannte Arbeiten in der Höhe. Wegen der Sturzgefahr bei Arbeiten in der Höhe soll auch diese Arbeit besser vom Fachmann durchgeführt werden. Führen Sie solche Aufgaben nicht selbst durch, sondern überlassen Sie die Arbeit einem Installationsfachmann oder Kundendienstfachmann.
- Berühren Sie nicht die Aluminiumrippen des Außengeräts. Anderenfalls können Sie sich verletzen. Wenn die Lamellen angefasst werden müssen, beauftragen Sie einen Installationsfachmann oder Kundendienstfachmann.
- Klettern Sie nicht auf das Außengerät, und stellen Sie keine Gegenstände darauf ab. Anderenfalls können Sie abstürzen, oder Gegenstände können herunterfallen. In beiden Fällen besteht Verletzungsgefahr.
- Stellen Sie keine Verbrennungsvorrichtung an Orten auf, wo sie direkt dem Wind der Klimaanlage ausgesetzt ist, da anderenfalls eine unvollständige Verbrennung die Folge ist.
- Wird die Klimaanlage zusammen mit einem Verbrennungsgerät in einem Raum betrieben, achten Sie auf eine ausreichende Belüftung des Raums. Reicht die Frischluftzufuhr nicht aus, kann Sauerstoffmangel entstehen.
- Wird die Klimaanlage in einem geschlossenen Raum betrieben, muss ebenfalls für eine ausreichende Frischluftzufuhr gesorgt werden. Reicht die Frischluftzufuhr nicht aus, kann Sauerstoffmangel entstehen.
- Setzen Sie Ihren Körper nicht für lange Zeit und in direkter Weise kühler Luft aus und vermeiden Sie Unterkühlung. Andernfalls könnten Ihr physischer Zustand und Ihre Gesundheit Schaden nehmen.
- Stecken Sie niemals einen Finger oder einen Stock in den Lufteinlass oder -auslass. Dies kann zu Verletzungen führen, weil der Ventilator innerhalb des Geräts mit einer hohen Geschwindigkeit rotiert.
- Wenden Sie sich an das Geschäft, in dem Sie die Klimaanlage gekauft haben, falls die Klimatisierung (Kühlung und Heizung) nicht richtig funktioniert, da dies an einem Kühlmittelleck liegen könnte. Besprechen Sie die Details der Reparatur mit einem qualifizierten Service-Techniker (*1), wenn die Reparatur eine zusätzliche Befüllung mit Kühlmittel umfasst.
- Schalten Sie vor einer Reinigung der Klimaanlage unbedingt ab und den Schutzschalter aus. Anderenfalls können Verletzungen die Folge sein, weil der Ventilator innerhalb des Geräts mit einer hohen Geschwindigkeit rotiert.

Reparaturen

- Falls Probleme mit der Klimaanlage auftreten (z. B. ein Fehler wird angezeigt, es riecht verbrannt, ungewöhnliche Geräusche sind zu hören, die Klimaanlage kühlt bzw. heizt nicht oder Wasser läuft aus), suchen Sie nicht selbst nach der Ursache, sondern stellen Sie den Schutzschalter auf die Position OFF (aus) und wenden Sie sich an einen Servicetechniker. Stellen Sie sicher, dass der Strom nicht wieder eingeschaltet wird (indem Sie beispielsweise den Schutzschalter durch „außer Betrieb“ kennzeichnen), bis ein qualifizierter Servicetechniker eintrifft. Die weitere Verwendung der Klimaanlage in fehlerhaftem Zustand kann zur Verschlimmerung der mechanischen Probleme oder zu elektrischen Schlägen und anderen Problemen führen.
- Wenn das Ventilatorgitter beschädigt ist, fassen Sie das Außengerät nicht an, sondern schalten Sie den Schutzschalter auf die Position OFF (aus) und rufen Sie einen Kundendienstfachmann, um die Reparatur durchzuführen. Stellen Sie den Schutzschalter erst wieder auf die Position ON (ein), nachdem die Reparaturen abgeschlossen wurden.
- Wenn die Gefahr besteht, dass das Innengerät herunterfällt, treten Sie nicht in die Nähe des Geräts, sondern schalten Sie den Schutzschalter aus und rufen Sie einen Installationsfachmann oder Kundendienstfachmann an. Den Schutzschalter erst wieder einschalten, nachdem der Einbau korrigiert wurde.
- Wenn die Gefahr besteht, dass das Außengerät umkippt, treten Sie nicht in die Nähe des Geräts, sondern schalten Sie den Schutzschalter aus und rufen Sie einen Installationsfachmann oder Kundendienstfachmann an. Den Schutzschalter erst wieder einschalten, nachdem der Einbau korrigiert wurde.
- Nehmen Sie keine individuellen Änderungen an dem Gerät vor. Dadurch können Brände, Stromschläge und andere Probleme entstehen.

Umsetzung

- Wenn die Klimaanlage umgezogen werden muss, unternehmen Sie diese nicht selbst, sondern beauftragen Sie einen Installationsfachmann oder Kundendienstfachmann. Wenn der Umzug einschließlich Ausbau und Einbau nicht fachmännisch erfolgt, besteht Stromschlag- und Feuergefahr.

⚠ VORSICHT

Trennen des Geräts von der Hauptstromversorgung.

- Dieses Gerät muss über einen Schalter mit einem Kontaktabstand von mindestens 3 mm an das Stromnetz angeschlossen werden.

Die Installationssicherung muss für die Stromversorgungsleitung dieser Klimaanlage verwendet werden (hierfür können alle Typen verwendet werden).

Installation

- Verlegen Sie die Kondensatleitung ordentlich, um das korrekte Abfließen des Wassers sicherzustellen. Eine schlecht verlegte Kondensatleitung kann zu Überschwemmungen im Haus und Wasserschäden an Möbeln führen.
- Achten Sie darauf, die Klimaanlage an eine eigene Stromzufuhr mit der vorgeschriebenen Netzspannung anzuschließen, da das Gerät ansonsten beschädigt werden oder ein Feuer verursachen könnte.
- Stellen Sie sicher, dass die Außengeräte auf der Grundplatte befestigt sind. Andernfalls könnten die Geräte herunterfallen oder andere Unfälle hervorgerufen werden.











Bedienung

- Diese Klimaanlage eignet sich nicht für spezielle Zwecke, weder für die Konservierung von Lebensmitteln, Präzisionsinstrumenten und Kunstobjekten noch zur Aufzucht von Tieren, der Zucht von Topfpflanzen, in einem Fahrzeug, Schiff, usw.
- Berühren Sie die Tasten zur Bedienung des Geräts nicht mit nassen Fingern, da Sie dann Gefahr laufen, einen Stromschlag zu bekommen.
- Wird die Klimaanlage voraussichtlich über einen längeren Zeitraum nicht gebraucht, schalten Sie sicherheitshalber den Hauptschalter oder Schutzschalter aus.
- Damit die Klimaanlage die zugesagte Leistung erbringen kann, betreiben Sie es nur im spezifizierten Temperaturbereich. Andernfalls kann es zu Störungen des Geräts oder zu Wasseraustritten aus dem Gerät kommen.
- Achten Sie darauf, dass keine Flüssigkeit in die Fernbedienung eindringt. Verschütten Sie keine Säfte, Wasser oder andere Flüssigkeiten.
- Waschen Sie die Klimaanlage nicht. Dies kann zu Stromschlägen führen.
- Überprüfen Sie, ob der Zustand der Installationsgrundplatte und anderer Ausrüstungsteile sich nach längerer Verwendung verschlechtert haben. Wenn Sie sie in einem solchen Zustand belassen, kann dies dazu führen, dass das Gerät herunterfällt und Verletzungen hervorruft.
- Lassen Sie keine entflammabaren Sprays oder andere entflammabare Stoffe in der Nähe der Klimaanlage, und sprühen Sie kein entflammbares Aerosol direkt in die Klimaanlage. Sie könnten in Brand geraten.
- Schalten Sie vor einer Reinigung der Klimaanlage unbedingt ab und den Schutzschalter aus. Andernfalls können Verletzungen die Folge sein, weil der Ventilator innerhalb des Geräts mit einer hohen Geschwindigkeit rotiert.
- Sorgen Sie dafür, dass die Reinigung der Klimaanlage vom Fachhändler durchgeführt wird. Eine Reinigung der Klimaanlage in unsachgemäßer Weise kann Schäden an Kunststoffteilen, Isolierfehler elektrischer oder anderer Teile sowie Fehlfunktionen zur Folge haben. Schlimmstenfalls kann es zu Wasseraustritten, Stromschlägen, Rauchentwicklung oder Bränden kommen.
- Stellen Sie keinen Wasserbehälter, wie z.B. eine Vase, auf das Gerät. Es besteht die Möglichkeit, dass Wasser in das Gerät eindringt, und dies könnte zur Verschlechterung der elektrischen Isolierung und zu einem Stromschlag führen.
- Waschen Sie nicht Klimaanlagen mit Druckwaschanlagen. Elektrische Lecks können zu Stromschlägen oder Bränden führen.

(*1) Siehe „Definition der Bezeichnungen Qualifizierter Installateur oder Qualifizierter Servicetechniker“.

■ Informationen zum Transport, zur Handhabung und Lagerung des Kartons

Beispiele für Hinweise auf dem Karton

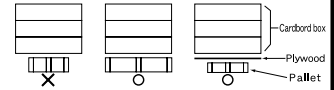
Symbol	Beschreibung	Symbol	Beschreibung
	Vor Nässe schützen		Nicht fallen lassen
	Zerbrechlich		Aufrecht transportieren
 11 cartons	Stapelhöhe (in diesem Fall max. 12 Kartons)		Hier nicht betreten
	Oben		Nicht betreten
	Vorsichtig handhaben		
Andere Hinweise zur Vorsicht		Beschreibung	
 <div style="border: 1px solid black; padding: 5px; display: inline-block;"> <p>Caution Injury possibility. Don't handle with packing band, or may get injured in case of broken band.</p> </div>		<p>VORSICHT Verletzungsgefahr. Nicht an den Packbändern heben, die Bändern können reißen.</p>	
<p>Stacking notice.</p> <p>In case that cardboard boxes protrude out of pallet when stacking, lay a 10mm thick plywood over the pallet.</p> 		<p>Stapelhinweis. Wenn die Kartonkisten beim Stapeln an der Palette überstehen, eine 10 mm starke Holzplatte über die Palette legen.</p>	

Grazie per aver acquistato questo Toshiba condizionatore d'aria.

Si prega di leggere attentamente queste istruzioni perché contengono informazioni importanti sulla conformità alla direttiva "Macchinari" (2006/42/CE).

Al termine della lettura delle presenti istruzioni, assicurarsi di conservarle in un luogo sicuro, insieme al Manuale del proprietario e al Manuale di installazione in dotazione con il prodotto.

Denominazione generica: Condizionatore d'aria





Definizione di installatore qualificato o tecnico dell'assistenza qualificato

Il condizionatore d'aria deve essere installato, sottoposto a manutenzione, riparato e rimosso da un installatore qualificato o da un tecnico dell'assistenza qualificato. Quando deve essere eseguito uno di questi lavori, rivolgersi a un installatore qualificato o a un tecnico dell'assistenza qualificato per svolgerli in propria vece.

Un installatore qualificato o un tecnico dell'assistenza qualificato è un agente che dispone delle qualifiche e dell'esperienza descritti nella tabella seguente.

Agente	Qualifiche ed esperienza di cui deve disporre l'agente
Installatore qualificato	<ul style="list-style-type: none"> L'installatore qualificato è una persona che installa, effettua la manutenzione, sposta e rimuove i condizionatori d'aria costruiti da Toshiba Carrier Corporation. Ha ricevuto la formazione necessaria per installare, mantenere, spostare e rimuovere i condizionatori d'aria costruiti da Toshiba Carrier Corporation o, in alternativa, è stato addestrato da uno o più individui in possesso della necessaria formazione, ed è pertanto idoneo a svolgere tali operazioni. L'installatore qualificato autorizzato a eseguire i lavori elettrici richiesti per l'installazione, il trasferimento e la rimozione del condizionatore d'aria possiede le qualifiche necessarie per svolgere tali compiti, come stabilito dalle leggi e dai regolamenti locali; è stato addestrato a lavorare sui condizionatori d'aria direttamente da Toshiba Carrier Corporation o da uno o più individui in possesso della necessaria formazione ed è pertanto idoneo a svolgere tale lavoro. L'installatore qualificato autorizzato a eseguire i lavori di gestione del refrigerante e di posa dei tubi richiesti per l'installazione, il trasferimento e la rimozione del condizionatore d'aria possiede le qualifiche necessarie per svolgere tali compiti, come stabilito dalle leggi e dai regolamenti locali; è stato addestrato a lavorare a svolgere i lavori di gestione del refrigerante e di posa dei tubi direttamente da Toshiba Carrier Corporation o da uno o più individui in possesso della necessaria formazione ed è pertanto idoneo a svolgere tale lavoro. L'installatore qualificato autorizzato a svolgere lavori in altezza ha ricevuto la formazione necessaria per effettuare tali lavori con i condizionatori d'aria costruiti da Toshiba Carrier Corporation o, in alternativa, è stato addestrato da uno o più individui in possesso della necessaria formazione, ed è pertanto idoneo a svolgere tali operazioni.
Tecnico dell'assistenza qualificato	<ul style="list-style-type: none"> Il personale di assistenza qualificato è una persona che installa, ripara, effettua la manutenzione, sposta e rimuove i condizionatori d'aria costruiti da Toshiba Carrier Corporation. Ha ricevuto la formazione necessaria per installare, riparare, mantenere, spostare e rimuovere i condizionatori d'aria costruiti da Toshiba Carrier Corporation o, in alternativa, è stato addestrato da uno o più individui in possesso della necessaria formazione, ed è pertanto idoneo a svolgere tali operazioni. Il personale di assistenza qualificato autorizzato a eseguire i lavori elettrici richiesti per l'installazione, il trasferimento e la rimozione del condizionatore d'aria possiede le qualifiche necessarie per svolgere tali compiti, come stabilito dalle leggi e dai regolamenti locali; è stato addestrato a lavorare sui condizionatori d'aria direttamente da Toshiba Carrier Corporation o da uno o più individui in possesso della necessaria formazione ed è pertanto idoneo a svolgere tale lavoro. Il personale di assistenza qualificato autorizzato a eseguire i lavori di gestione del refrigerante e di posa dei tubi richiesti per l'installazione, la riparazione, il trasferimento e la rimozione del condizionatore d'aria possiede le qualifiche necessarie per svolgere tali compiti, come stabilito dalle leggi e dai regolamenti locali; è stato addestrato a lavorare a svolgere i lavori di gestione del refrigerante e di posa dei tubi direttamente da Toshiba Carrier Corporation o da uno o più individui in possesso della necessaria formazione ed è pertanto idoneo a svolgere tale lavoro. Il personale di assistenza qualificato autorizzato a svolgere lavori in altezza ha ricevuto la formazione necessaria per effettuare tali lavori con i condizionatori d'aria costruiti da Toshiba Carrier Corporation o, in alternativa, è stato addestrato da uno o più individui in possesso della necessaria formazione, ed è pertanto idoneo a svolgere tali operazioni.

■ Indicazioni di avvertimento sul condizionatore d'aria

Indicazione di avvertimento	Descrizione		
 <table border="1"> <tr> <td>WARNING</td> </tr> <tr> <td>ELECTRICAL SHOCK HAZARD Disconnect all remote electric power supplies before servicing.</td> </tr> </table>	WARNING	ELECTRICAL SHOCK HAZARD Disconnect all remote electric power supplies before servicing.	<p>AVVERTENZA</p> <p>PERICOLO DI SCOSSA ELETTRICA Scollegare tutte le fonti di alimentazione elettrica remota, prima di sottoporre a interventi di assistenza.</p>
WARNING			
ELECTRICAL SHOCK HAZARD Disconnect all remote electric power supplies before servicing.			
 <table border="1"> <tr> <td>WARNING</td> </tr> <tr> <td>Moving parts. Do not operate unit with grille removed. Stop the unit before the servicing.</td> </tr> </table>	WARNING	Moving parts. Do not operate unit with grille removed. Stop the unit before the servicing.	<p>AVVERTENZA</p> <p>Parti mobili. Non far funzionare l'unità con la griglia rimossa. Arrestare l'unità prima di sottoporla ad assistenza.</p>
WARNING			
Moving parts. Do not operate unit with grille removed. Stop the unit before the servicing.			
 <table border="1"> <tr> <td>CAUTION</td> </tr> <tr> <td>High temperature parts. You might get burned when removing this panel.</td> </tr> </table>	CAUTION	High temperature parts. You might get burned when removing this panel.	<p>ATTENZIONE</p> <p>Parti ad alta temperatura. Quando si rimuove questo pannello sussiste il pericolo di ustione.</p>
CAUTION			
High temperature parts. You might get burned when removing this panel.			
 <table border="1"> <tr> <td>CAUTION</td> </tr> <tr> <td>Do not touch the aluminum fins of the unit. Doing so may result in injury.</td> </tr> </table>	CAUTION	Do not touch the aluminum fins of the unit. Doing so may result in injury.	<p>ATTENZIONE</p> <p>Non toccare le alette di alluminio dell'unità. In caso contrario, si potrebbero provocare lesioni personali.</p>
CAUTION			
Do not touch the aluminum fins of the unit. Doing so may result in injury.			
 <table border="1"> <tr> <td>CAUTION</td> </tr> <tr> <td>BURST HAZARD Open the service valves before the operation, otherwise there might be the burst.</td> </tr> </table>	CAUTION	BURST HAZARD Open the service valves before the operation, otherwise there might be the burst.	<p>ATTENZIONE</p> <p>PERICOLO DI SCOPPIO Aprire le valvole di servizio prima dell'operazione; in caso contrario, si potrebbe verificare uno scoppio.</p>
CAUTION			
BURST HAZARD Open the service valves before the operation, otherwise there might be the burst.			

1 Precauzioni per la sicurezza

Il produttore non si assume alcuna responsabilità per i danni causati dalla mancata osservazione delle descrizioni del presente manuale.

AVVERTENZA

Generali

- Leggere con attenzione il Manuale del proprietario prima di iniziare a utilizzare il condizionatore d'aria. Vi sono molte cose importanti da tenere a mente per il funzionamento quotidiano.
- L'installazione deve essere affidata al proprio rivenditore o a un tecnico qualificato. Solo questi professionisti(*1) sono infatti in grado di eseguirla correttamente. Affidandola a persone non qualificate si potrebbero verificare un incendio, scosse elettriche, perdite d'acqua, generazione di rumore o vibrazioni o, ancora, lesioni per le persone.
- Per rimbocchi o sostituzioni, non utilizzare refrigeranti diversi da quello indicato. In caso contrario nel ciclo di refrigerazione si può generare una pressione eccessiva, che può generare guasti, esplosione del prodotto o lesioni personali.
- Fare attenzione ai possibili luoghi d'installazione ove il rumore dell'unità esterna potrebbe arrecare disturbo. (Specialmente nei punti di confine con altre proprietà.)

Trasporto e magazzinaggio

- Per trasportare il condizionatore si raccomanda di calzare scarpe rinforzate sulla punta nonché indossare guanti e altro abbigliamento protettivo.
- Quando si trasporta il condizionatore d'aria, non afferrare le fascette che circondano la scatola di imballaggio. Qualora le fascette si rompano, si potrebbero subire lesioni personali.
- Prima di impilare i cartoni di imballaggio per il magazzinaggio o il trasporto, seguire le precauzioni riportate sui cartoni. La mancata osservanza di questa precauzione potrebbe provocare la caduta della pila.
- Il condizionatore deve essere trasportato in condizioni stabili. Qualora una parte qualsiasi dovesse apparire non integra si raccomanda di rivolgersi immediatamente al proprio rivenditore.
- Se il condizionatore deve essere trasportato manualmente, l'operazione deve essere effettuata da due o più persone.

Installazione

- Solo un installatore qualificato(*1) o un tecnico dell'assistenza qualificato(*1) sono autorizzati a eseguire i lavori sull'impianto elettrico per il condizionatore d'aria. In nessuna circostanza tali lavori devono essere effettuati da una persona non qualificata, poiché un'esecuzione non appropriata dei lavori potrebbe provocare scosse elettriche e/o dispersioni di corrente.
- Al termine del lavoro di installazione, chiedere all'installatore di illustrare le posizioni dell'interruttore. Nelle eventualità di un guasto del condizionatore d'aria, portare l'interruttore su OFF e contattare il personale dell'assistenza.
- Se si installa l'unità in una stanza piccola, adottare le misure appropriate affinché, in caso di perdita di refrigerante, la concentrazione di quest'ultimo nella stanza non superi il limite consentito. Quando si implementano tali misure, consultare il rivenditore da cui si è acquistato il condizionatore d'aria. L'accumulo di elevate concentrazioni di refrigerante potrebbe provocare un incidente dovuto a carenza di ossigeno.
- Non installare il condizionatore d'aria in una sede che possa essere soggetta al rischio di esposizione a gas combustibili. Qualora si verifici una perdita e la concentrazione di un gas combustibile in prossimità dell'apparecchio, sussiste il rischio di incendio.
- Per le parti da acquistare a parte usare esclusivamente quelle specificate dal costruttore. L'uso di prodotti non specifici può causare incendi, scosse elettriche, perdite di acqua o altri problemi. La loro installazione deve inoltre essere affidata a un tecnico qualificato.
- Accertarsi infine che i collegamenti a terra siano stati correttamente eseguiti.

Funzionamento

- Prima di aprire la griglia della presa d'aria dell'unità interna o il pannello di servizio dell'unità esterna, impostare l'interruttore automatico sulla posizione OFF (spento). La mancata impostazione dell'interruttore automatico sulla posizione OFF (spento) potrebbe provocare scosse elettriche attraverso il contatto con le parti interne. Solo un installatore qualificato(*1) o un tecnico dell'assistenza qualificato(*1) sono autorizzati a rimuovere la griglia della presa d'aria o il pannello di servizio dell'unità esterna e a svolgere il lavoro richiesto.
- All'interno del condizionatore d'aria esistono parti in movimento e aree ad alta tensione. Per scongiurare il pericolo di elettrocuzione o di intrappolamento delle dita o di altri oggetti nelle parti in movimento, non rimuovere il pannello di servizio dell'unità esterna. Se occorre eseguire un lavoro che implichi la rimozione di questi elementi, contattare un installatore qualificato o il personale di assistenza qualificato.
- Non tentare di spostare o riparare l'unità da soli. All'interno dell'unità è presente alta tensione, pertanto, la rimozione del coperchio e lo spostamento dell'unità principale potrebbero esporre al rischio di elettrocuzione.
- Per pulire il filtro dell'unità interna o per eseguire altre attività considerate come "lavori in altezza" utilizzare un supporto più alto di 50 cm. A motivo del pericolo di caduta dal supporto e quindi del rischio di lesioni o ferite, i lavori in altezza dovrebbe essere eseguiti esclusivamente da persone qualificate. Se la situazione richiede questi tipi di lavori, rivolgersi a un installatore qualificato o al personale di assistenza qualificato.
- Non toccare l'aletta di alluminio dell'unità esterna. In caso contrario, si potrebbero provocare lesioni personali. Se la situazione richiede che le alette vengano toccate, rivolgersi a un installatore qualificato o al personale di assistenza qualificato.
- Non salire né collocare oggetti sull'unità esterna. Si potrebbe cadere o gli oggetti potrebbero cadere dall'unità esterna e provocare lesioni personali.
- Non collocare apparecchi a combustione di alcun genere in luoghi che siano direttamente esposti al flusso d'aria prodotto dal condizionatore d'aria; in caso contrario, il condizionatore potrebbe provocare una combustione imperfetta.
- Quando il condizionatore viene utilizzato con un apparecchio a combustione presente, ventilare adeguatamente l'ambiente. La scarsa ventilazione provoca carenza di ossigeno.
- Se il condizionatore d'aria viene utilizzato in un locale chiuso, ventilare adeguatamente l'ambiente. La scarsa ventilazione provoca carenza di ossigeno.
- Non sostare a lungo nel flusso d'aria fredda, né lasciare raffreddare eccessivamente il corpo. Ciò potrebbe infatti deteriorare le condizioni fisiche e causare problemi di salute.
- Non inserire le dita né altri corpi estranei nella presa d'ingresso o di scarico dell'aria. Ci si potrebbe infatti ferire a causa dell'alta velocità di rotazione della ventola interna.
- Se il condizionatore non riscalda o raffredda adeguatamente l'ambiente, probabilmente a causa di una perdita di refrigerante, è raccomandabile rivolgersi al proprio rivenditore. Se l'intervento richiede una carica aggiuntiva di refrigerante è opportuno di ottenere dal tecnico di assistenza ogni possibile informazione particolareggiata(*1).
- Prima di pulire il condizionatore lo si deve spegnere e si deve inoltre disinserire l'interruttore a monte. Ci si potrebbe infatti ferire a causa dell'alta velocità di rotazione della ventola interna.

Riparazioni

- Se si nota il verificarsi di un problema di qualche tipo con il condizionatore d'aria (ad esempio è stata visualizzata un'indicazione di errore, si sente odore di bruciato, si sentono rumori anomali, il condizionatore non raffredda o non riscalda, o è presente una perdita d'acqua), non toccare da soli il condizionatore d'aria, ma impostare l'interruttore sulla posizione OFF (spento) e contattare un tecnico dell'assistenza qualificato. Adottare delle misure per assicurare che l'unità non venga accesa (ad esempio scrivendo "fuori servizio" in prossimità dell'interruttore automatico) fino all'arrivo di un tecnico dell'assistenza qualificato. L'uso continuato del condizionatore in questa condizione anomala potrebbe divenire causa di problemi meccanici, generare scosse elettriche o causare altri problemi.
- Se la griglia della ventola è danneggiata, non avvicinarsi all'unità esterna ma portare l'interruttore in posizione OFF (spento) e rivolgersi al personale di assistenza qualificato affinché provveda a effettuare le necessarie riparazioni. Non impostare l'interruttore automatico sulla posizione ON (acceso) finché non siano state completate le riparazioni.
- Se esiste il pericolo che l'unità interna possa cadere, non avvicinarsi, portare l'interruttore sulla posizione OFF e contattare un installatore qualificato o il personale di assistenza qualificato affinché rimontino l'unità. Non riportare l'interruttore in posizione ON fino a quando l'unità non sia stata rimontata.
- Se esiste il pericolo che l'unità esterna possa cadere, non avvicinarsi, portare l'interruttore sulla posizione OFF e contattare un installatore qualificato o il personale di assistenza qualificato affinché fissino o rimontino l'unità. Non riportare l'interruttore in posizione ON fino a quando le riparazioni non siano state completate.
- Non si deve "personalizzare" in alcun modo il condizionatore. In caso contrario si potrebbero verificare un incendio, scosse elettriche o altri problemi.

Trasferimento

- Se il condizionatore d'aria deve essere trasferito, rivolgersi a un installatore qualificato o al personale di assistenza qualificato. Se il trasferimento del condizionatore d'aria fosse eseguito in maniera errata potrebbe esistere il rischio di elettrocuzione e/o incendio.

⚠ ATTENZIONE

Per scollegare l'apparecchio dall'alimentazione della rete elettrica

- Questo apparecchio deve essere collegato alla rete elettrica per mezzo di un interruttore con separazione dei contatti di almeno 3 mm.

La linea di alimentazione elettrica del condizionatore deve essere protetta con un fusibile (di qualsiasi tipo).

Installazione

- Posare correttamente il tubo di scarico, in modo da garantire uno scarico perfetto. Uno scarico inadatto potrebbe provocare l'allagamento dell'edificio e bagnare l'arredamento.
- Collegare il condizionatore d'aria a una rete di alimentazione dedicata con tensione di alimentazione corrispondente a quella nominale, altrimenti l'unità potrebbe guastarsi o causare incendi.
- Accertarsi che l'unità esterna sia ben fissata alla base di supporto. In caso contrario potrebbe ribaltarsi o causare altri problemi.









Funzionamento

- Non utilizzare il condizionatore d'aria per scopi particolari, quali ad esempio la conservazione di alimenti, strumenti di precisione, oggetti d'arte, vetture o imbarcazioni, l'allevamento di animali.
- Non toccare gli interruttori con le dita bagnate, altrimenti si può incorrere in una elettrocuzione.
- Se il condizionatore d'aria non verrà utilizzato per un lungo periodo di tempo, disinserire l'interruttore principale o l'interruttore.
- Per far sì che il condizionatore possa garantire prestazioni ottimali, utilizzarlo negli intervalli di temperatura specificati nelle istruzioni. In caso contrario l'unità potrebbe guastarsi o essere soggetta a perdite d'acqua.
- Fare attenzione a non versare liquidi sul telecomando. Proteggerlo da succhi di frutta, acqua o qualsiasi altro tipo di liquido.
- Non lavare il condizionatore con acqua. Si potrebbe infatti ricevere una scossa elettrica.
- Trascorso molto tempo dall'installazione iniziale è opportuno accertarsi che la base d'installazione e ogni altra parte ancora non si sia deteriorata. Lasciarle in tale condizione ne potrebbe causare il ribaltamento con conseguente pericolo per le persone.
- Non lasciare prodotti spray né altri materiali infiammabili nei pressi del condizionatore, né spruzzarli direttamente dentro le unità. Si potrebbero infatti incendiare.
- Prima di pulire il condizionatore lo si deve spegnere e si deve inoltre disinserire l'interruttore a monte. Ci si potrebbe infatti ferire a causa dell'alta velocità di rotazione della ventola interna.
- Per la pulizia del condizionatore è raccomandabile rivolgersi al proprio rivenditore. Eseguendo la pulizia del condizionatore in modo improprio se ne potrebbero danneggiare le parti di plastica e il materiale isolante di parti elettriche o di altro tipo, con conseguente pericolo di malfunzionamento o guasto. Nel peggiore dei casi si potrebbero verificare perdite d'acqua, scosse elettriche, emissione di fumo o un incendio.
- Non appoggiare contenitori liquidi - ad esempio vasi - sull'unità esterna. Se l'acqua dovesse penetrare nell'unità, infatti, potrebbe deteriorare i materiali elettroisolanti con conseguente pericolo di scosse elettriche.
- Non lavare i condizionatori d'aria con dispositivi di lavaggio a pressione. Le dispersioni di corrente elettrica possono provocare scosse elettriche o incendi.

(*1) Consultare la "Definizione di installatore qualificato o tecnico dell'assistenza qualificato".

■ Informazioni sul trasporto, la gestione e il magazzinaggio del cartone

Esempi di indicazioni riportate sul cartone

Simbolo	Descrizione	Simbolo	Descrizione
	Conservare all'asciutto		Non far cadere
	Fragile		Non coricare
	Altezza di impilaggio (in questo caso possono essere impilati 12 cartoni)		Non camminare su questo cartone
	Alto		Non calpestare
	Maneggiare con cura		

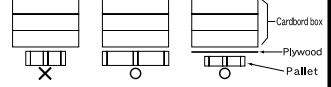
Altre precauzioni	Descrizione
 Caution Injury possibility. Don't handle with packing band, or may get injured in case of broken band.	ATTENZIONE Possibilità di lesioni. Non afferrare le reglette di plastica; in caso di rottura potrebbero causare lesioni.
Stacking notice. In case that cardboard boxes protrude out of pallet when stacking, lay a 10mm thick plywood over the pallet. 	Avviso di impilaggio. Se le scatole di cartone sporgono dal bancale dopo l'impilaggio. Stendere sulla bancale un foglio di compensato dello spessore di 10 mm.

Gracias por haber adquirido este aparato de aire acondicionado Toshiba.

Lea atentamente estas instrucciones que contienen información importante de conformidad con la Directiva relativa a "Máquinas" (Directiva 2006 / 42 / EC) y asegúrese de que las entiende.

Después de leer estas instrucciones, asegúrese de guardarlas en un lugar seguro junto con el manual del propietario y el manual de instrucciones suministrado con su producto.

Denominación genérica: Aire acondicionado





Definición de instalador cualificado o persona de servicio cualificada

El aparato de aire acondicionado deberá ser instalado, mantenido, reparado y desechado por un instalador cualificado o por una persona de servicio cualificada. Cuando se tenga que hacer uno cualquiera de estos trabajos, solicite a un instalador cualificado o a una persona de servicio cualificada que le haga el trabajo solicitado.

Un instalador cualificado o una persona de servicio cualificada es un agente con las cualificaciones y conocimientos descritos en la tabla de abajo.

Agente	Cualificaciones y conocimientos que debe tener el agente
Instalador cualificado	<ul style="list-style-type: none"> El instalador cualificado es una persona que se dedica a la instalación, mantenimiento, traslado y retirada de los aparatos de aire acondicionado fabricados por Toshiba Carrier Corporation. Dicha persona habrá recibido formación relativa a la instalación, mantenimiento, traslado y retirada de aparatos de aire acondicionado fabricados por Toshiba Carrier Corporation, o, de otro modo, habrá sido instruida en dichas operaciones por otra u otras personas que hayan recibido formación en la materia y que por tanto posean amplios conocimientos relativos a dichas operaciones. El instalador cualificado que esté autorizado para realizar los trabajos eléctricos propios de la instalación, traslado y retirada poseerá las cualificaciones relativas a dichos trabajos eléctricos, de conformidad con la legislación local vigente, y habrá recibido formación relativa a las tareas eléctricas a realizar en los aparatos de aire acondicionado fabricados por Toshiba Carrier Corporation, o, de otro modo, habrá sido instruido en dichas tareas por otra u otras personas que hayan recibido formación en la materia y que por tanto posean amplios conocimientos relativos a dichas operaciones. El instalador cualificado que esté autorizado para realizar los trabajos de canalización y manejo del refrigerante propios de la instalación, traslado y retirada poseerá las cualificaciones relativas a dichos trabajos de canalización y manejo del refrigerante, de conformidad con la legislación local vigente, y habrá recibido formación relativa a las tareas de canalización y uso del refrigerante a realizar en los aparatos de aire acondicionado fabricados por Toshiba Carrier Corporation, o, de otro modo, habrá sido instruido en dichas tareas por otra u otras personas que hayan recibido formación en la materia y que por tanto posean amplios conocimientos relativos a dichas operaciones. El instalador cualificado que esté autorizado para trabajar en alturas habrá recibido formación relativa a la realización de trabajos en altura con los aparatos de aire acondicionado fabricados por Toshiba Carrier Corporation, o, de otro modo, habrá sido instruido en dichas tareas por otra u otras personas que hayan recibido formación en la materia y que por tanto posean amplios conocimientos relativos a dichos trabajos.
Persona de servicio cualificada	<ul style="list-style-type: none"> La persona de mantenimiento cualificado es una persona que se dedica a la instalación, reparación, mantenimiento, traslado y retirada de los aparatos de aire acondicionado fabricados por Toshiba Carrier Corporation. Dicha persona habrá recibido formación relativa a la instalación, reparación, mantenimiento, traslado y retirada de aparatos de aire acondicionado fabricados por Toshiba Carrier Corporation, o, de otro modo, habrá sido instruida en dichas operaciones por otra u otras personas que hayan recibido formación en la materia y que por tanto posean amplios conocimientos relativos a dichas operaciones. La persona de mantenimiento cualificada que esté autorizada para realizar los trabajos eléctricos propios de la instalación, reparación, traslado y retirada poseerá las cualificaciones relativas a dichos trabajos eléctricos, de conformidad con la legislación local vigente, y habrá recibido formación relativa a las tareas eléctricas a realizar en los aparatos de aire acondicionado fabricados por Toshiba Carrier Corporation, o, de otro modo, habrá sido instruida en dichas tareas por otra u otras personas que hayan recibido formación en la materia y que por tanto posean amplios conocimientos relativos a dichas operaciones. La persona de mantenimiento cualificada que esté autorizada para realizar los trabajos de canalización y manejo del refrigerante propios de la instalación, reparación, traslado y retirada poseerá las cualificaciones relativas a dichos trabajos de canalización y manejo del refrigerante, de conformidad con la legislación local vigente, y habrá recibido formación relativa a las tareas de canalización y uso del refrigerante a realizar en los aparatos de aire acondicionado fabricados por Toshiba Carrier Corporation, o, de otro modo, habrá sido instruida en dichas tareas por otra u otras personas que hayan recibido formación en la materia y que por tanto posean amplios conocimientos relativos a dichas operaciones. La persona de mantenimiento cualificada que esté autorizada para trabajar en alturas habrá recibido formación relativa a la realización de trabajos en altura con los aparatos de aire acondicionado fabricados por Toshiba Carrier Corporation, o, de otro modo, habrá sido instruida en dichas tareas por otra u otras personas que hayan recibido formación en la materia y que por tanto posean amplios conocimientos relativos a dichos trabajos.

■ Advertencias en cuanto a la unidad de aire acondicionado

Indicación de advertencia	Descripción		
 <table border="1"> <tr> <td>WARNING</td> </tr> <tr> <td>ELECTRICAL SHOCK HAZARD Disconnect all remote electric power supplies before servicing.</td> </tr> </table>	WARNING	ELECTRICAL SHOCK HAZARD Disconnect all remote electric power supplies before servicing.	<p>ADVERTENCIAS</p> <p>PELIGRO DE DESCARGA ELÉCTRICA Desconecte todos los suministros eléctricos remotos antes de hacer reparaciones.</p>
WARNING			
ELECTRICAL SHOCK HAZARD Disconnect all remote electric power supplies before servicing.			
 <table border="1"> <tr> <td>WARNING</td> </tr> <tr> <td>Moving parts. Do not operate unit with grille removed. Stop the unit before the servicing.</td> </tr> </table>	WARNING	Moving parts. Do not operate unit with grille removed. Stop the unit before the servicing.	<p>ADVERTENCIAS</p> <p>Piezas móviles. No utilice la unidad con la rejilla retirada. Pare la unidad antes de hacer reparaciones.</p>
WARNING			
Moving parts. Do not operate unit with grille removed. Stop the unit before the servicing.			
 <table border="1"> <tr> <td>CAUTION</td> </tr> <tr> <td>High temperature parts. You might get burned when removing this panel.</td> </tr> </table>	CAUTION	High temperature parts. You might get burned when removing this panel.	<p>PRECAUCIÓN</p> <p>Piezas de alta temperatura. Al retirar este panel podría quemarse.</p>
CAUTION			
High temperature parts. You might get burned when removing this panel.			
 <table border="1"> <tr> <td>CAUTION</td> </tr> <tr> <td>Do not touch the aluminum fins of the unit. Doing so may result in injury.</td> </tr> </table>	CAUTION	Do not touch the aluminum fins of the unit. Doing so may result in injury.	<p>PRECAUCIÓN</p> <p>No toque las aletas de aluminio de la unidad. De lo contrario, podrían producirse lesiones personales.</p>
CAUTION			
Do not touch the aluminum fins of the unit. Doing so may result in injury.			
 <table border="1"> <tr> <td>CAUTION</td> </tr> <tr> <td>BURST HAZARD Open the service valves before the operation, otherwise there might be the burst.</td> </tr> </table>	CAUTION	BURST HAZARD Open the service valves before the operation, otherwise there might be the burst.	<p>PRECAUCIÓN</p> <p>PELIGRO DE ROTURA Abra las válvulas de servicio antes de la operación, de lo contrario podrían producirse roturas.</p>
CAUTION			
BURST HAZARD Open the service valves before the operation, otherwise there might be the burst.			

1 Precauciones de seguridad

El fabricante no se hará responsable de ningún daño producido por no seguir las descripciones de este manual.

ADVERTENCIAS

Generalidades

- Lea atentamente este Manual del propietario antes de poner en marcha el aparato de aire acondicionado. Debe recordar muchos datos importantes relacionados con el funcionamiento general la unidad.
- Solicite que el distribuidor o un profesional realice la instalación. Sólo un instalador calificado (*1) puede realizar la instalación del acondicionador de aire. Si lo instala una persona no calificada puede provocar problemas como incendios, descargas eléctricas, lesiones, fugas de agua, ruidos y vibraciones.
- No utilice ningún refrigerante distinto del especificado como complemento o sustituto. Si lo hace, se podría generar una presión extremadamente alta en el ciclo de refrigeración, lo que podría causar un fallo en el producto, la explosión de este o daños físicos.
- Lugares donde el ruido de funcionamiento de la unidad exterior puede provocar inconvenientes. (Especialmente en la divisoria con un vecino, instale el acondicionador de aire teniendo en cuenta el ruido.)

Transporte y almacenamiento

- Utilice zapatos con punteras, guantes y vestimenta de protección para transportar el aparato de aire acondicionado.
- No agarre las bandas que rodean la caja del embalaje para transportar la unidad de aire acondicionado. Usted podría lesionarse si se rompieran las bandas.
- Antes de apilar las cajas de cartón para el almacenamiento o transporte, tenga en cuenta las indicaciones de precaución que aparecen impresas en dichos embalajes. De no seguirse dichas precauciones, la pila de cajas podría caerse.
- La unidad de aire acondicionado se debe transportar en condiciones de estabilidad adecuadas. Si alguna pieza del producto estuviera rota, póngase en contacto con el distribuidor.
- Cuando la unidad de aire acondicionado se deba transportar con las manos, deberán hacerlo dos o más personas.

Instalación

- Sólo un instalador calificado(*1) o una persona de servicio calificada(*1) tiene permitido realizar el trabajo eléctrico del aparato de aire acondicionado. Este trabajo no deberá hacerlo, bajo ninguna circunstancia, un individuo que no esté calificado, porque si el trabajo se hace mal, existe el peligro de que se produzcan descargas eléctricas y/o fugas eléctricas.
- Una vez finalizada la instalación, pídale al instalador que le explique las posiciones del disyuntor. En el caso de que se haya producido un problema con el aparato de aire acondicionado, desconecte el disyuntor y póngase en contacto con una persona de mantenimiento.
- Si instala la unidad en una habitación pequeña, tome las medidas apropiadas para impedir que el refrigerante sobrepase la concentración límite aunque tuviera fugas. Consulte al concesionario a quien adquirió el aparato de aire acondicionado cuando ponga en práctica las medidas. La acumulación de refrigerante altamente concentrado puede causar un accidente por falta de oxígeno.
- No instale el aparato de aire acondicionado en un lugar donde pueda estar expuesto a un gas combustible. Si hay fugas de gas combustible y éste se concentra alrededor de la unidad, podría producirse un incendio.
- Utilice las piezas compradas por separado especificadas por la empresa. La utilización de piezas que no sean las especificadas podría provocar incendios, descargas eléctricas, fugas de agua u otros problemas. Un profesional debe realizar la instalación.
- Confirme que se realice la conexión a tierra correctamente.

Funcionamiento

- Antes de abrir la rejilla de admisión de la unidad interior o el panel de servicio de la unidad exterior, ponga el disyuntor en la posición OFF. Si no se pone el disyuntor en la posición OFF se puede producir una descarga eléctrica al tomar las piezas interiores. Sólo un instalador calificado(*1) o una persona de servicio calificada(*1) tiene permitido retirar la rejilla de admisión de la unidad interior o el panel de servicio de la unidad exterior y hacer el trabajo necesario.
- Dentro del aparato de aire acondicionado hay zonas de alto voltaje y piezas giratorias. Debido al peligro de descargas eléctricas o de que sus dedos u otros objetos físicos queden atrapados en las piezas giratorias, no retire el panel de mantenimiento de la unidad exterior. Cuando se requieran trabajos que supongan la retirada de estas piezas, póngase en contacto con un instalador calificado o una persona de mantenimiento calificada.
- No mueva ni repare ninguna unidad usted mismo. Dado que en el interior de la unidad hay alto voltaje, podría recibir una descarga eléctrica al retirar la cubierta y la unidad principal.
- El uso de una plataforma de más de 50 cm de altura para limpiar el filtro de la unidad interior o para realizar otros trabajos similares constituye un trabajo en alturas. Para evitar el peligro de caída de la plataforma y posibles lesiones físicas mientras se trabaja en alturas, este tipo de trabajo no debe realizarse por personas no calificadas. Cuando sea necesario realizar este tipo de trabajo, no lo realice usted mismo; en su lugar, acuda a una persona de mantenimiento calificada para que lo haga por usted.
- No toque la aleta de aluminio de la unidad exterior. Si lo hace puede lesionarse usted mismo. Si fuese necesario tocar la aleta, no la toque usted mismo; en su lugar, póngase en contacto con un instalador calificado o una persona de mantenimiento calificada.
- No se suba encima ni coloque objetos encima de la unidad exterior. Usted o los objetos pueden caerse de la unidad exterior y provocar lesiones.
- No ponga ningún aparato de combustión en un lugar expuesto directamente al aire procedente del aparato de aire acondicionado, de lo contrario, la combustión no sería perfecta.
- Ventile la habitación de manera suficiente cuando el aparato de aire acondicionado esté en funcionamiento en el mismo lugar que un aparato de combustión. Una mala ventilación puede ocasionar la falta de oxígeno.
- Si el aparato de aire acondicionado se utiliza en una habitación cerrada, ventílela de manera suficiente. Una mala ventilación puede ocasionar la falta de oxígeno.
- No se exponga directamente a una corriente de aire frío durante un lapso prolongado y evite el frío excesivo. De lo contrario puede ocurrir un deterioro de la integridad física o la salud.
- No inserte los dedos ni una varilla en la toma o la descarga de aire.
- De lo contrario podría lesionarse ya que el ventilador gira a alta velocidad dentro de la unidad.
- Consulte al proveedor del acondicionador de aire si la refrigeración y la calefacción no funcionan correctamente ya que la causa podría ser una fuga de refrigerante. Confirme los detalles de la reparación con personal de servicio calificado (*1) cuando la reparación incluya una carga de refrigerante adicional.
- Apague el aparato de aire acondicionado y desactive el disyuntor antes de realizar la limpieza. De lo contrario podría lesionarse ya que el ventilador gira a alta velocidad dentro de la unidad.

Reparación

- Si hubiera algún problema en el aparato de aire acondicionado (por ejemplo, cuando aparece una visualización de error, hay olor a quemado, se oyen ruidos anormales, el aparato de aire acondicionado no refrigera ni calienta o hay fugas de agua), no lo toque: desconecte antes el disyuntor y póngase en contacto con una persona de servicio calificada. Tome medidas (poniendo un aviso de "fuera de servicio" cerca del disyuntor, por ejemplo) para asegurar que la alimentación no se conecte antes de que llegue la persona de servicio calificada. Si se continúa utilizando la unidad de aire acondicionado con la anomalía, los problemas mecánicos podrían generar otras complicaciones o provocar descargas eléctricas u otro tipo de problemas.
- Si la rejilla del ventilador está dañada, no se dirija a la unidad exterior: desconecte el disyuntor y póngase en contacto con una persona de mantenimiento calificada para que la repare. No ponga el disyuntor en la posición ON hasta después de terminar las reparaciones.
- Si hay algún peligro en la unidad interior que falla, no se dirija a la unidad interior: desconecte el disyuntor y póngase en contacto con un instalador calificado o una persona de mantenimiento calificada para que repare la unidad. No conecte el disyuntor hasta que se haya reparado la unidad.
- Si hay algún peligro en la unidad exterior que ha caído, no se dirija a la unidad exterior: desconecte el disyuntor y póngase en contacto con un instalador calificado o una persona de mantenimiento calificada para que realice las mejoras o reparaciones oportunas. No conecte el disyuntor hasta que se hayan realizado las mejoras o reparaciones.
- No personalice la unidad. Podría provocar incendios, descargas eléctricas u otros problemas.

Recolocación

- Si se va a trasladar el aparato de aire acondicionado, no lo traslade usted mismo; en su lugar, póngase en contacto con un instalador calificado o una persona de mantenimiento calificada. Si el aparato de aire acondicionado no se traslada correctamente, se pueden producir descargas eléctricas y/o un incendio.

PRECAUCIÓN

Para desconectar el dispositivo de la fuente de alimentación.

- Este aparato debe estar conectado a la fuente de alimentación mediante un conmutador con una separación entre los contactos de al menos 3 mm.

Debe utilizarse un fusible de instalación (se pueden utilizar fusibles de todos los tipos) para la línea de suministro de energía eléctrica de este aparato de aire acondicionado.

Instalación

- Disponga correctamente la manguera de drenaje para un drenaje perfecto. Un drenaje incorrecto puede provocar un encharcamiento de agua en el interior de la vivienda, así como daños en el mobiliario.
- Conecte el aparato de aire acondicionado a una toma de corriente exclusiva con el voltaje especificado; de lo contrario, la unidad podría estropearse o provocar un incendio.
- Confirme que la unidad exterior esté fija en su base. De lo contrario la unidad podría caerse o provocar otro tipo de accidente.









Funcionamiento

- No utilice el aparato de aire acondicionado con finalidades especiales, como preservar alimentos, instrumentos de precisión, objetos de arte, reproducción de animales, en vehículos ni embarcaciones.
- No toque ningún interruptor con las manos mojadas; de lo contrario, podría recibir una descarga eléctrica.
- Si el aparato de aire acondicionado no va a utilizarse durante un período de tiempo prolongado, desconecte el interruptor principal (o disyuntor) por seguridad.
- Para obtener un rendimiento óptimo del aparato de aire acondicionado, utilícelo dentro del rango de la temperatura de funcionamiento especificada en las instrucciones. De lo contrario, podría producirse un funcionamiento erróneo o fugas de agua de la unidad.
- Evite que caiga líquido en el interior del control remoto. No derrame zumo, agua ni otro tipo de líquido sobre él.
- No lave el acondicionador de aire. De lo contrario, podrían producirse descargas eléctricas.
- Revise si la base de instalación y el resto del equipo presentan deterioro después de un lapso prolongado de funcionamiento. Si no toma las medidas necesarias, la unidad podría caerse y provocar lesiones.
- No deje pulverizadores inflamables ni otro tipo de material inflamable cerca del acondicionador de aire ni pulverice aerosoles inflamables directamente sobre él. Podría incendiarse.
- Apague el aparato de aire acondicionado y desactive el disyuntor antes de realizar la limpieza. De lo contrario podría lesionarse ya que el ventilador gira a alta velocidad dentro de la unidad.
- Solicite al distribuidor que realice la limpieza del acondicionador de aire. Si limpia el acondicionador de aire de manera incorrecta, podría dañar las piezas plásticas, el aislamiento de las piezas eléctricas u otras y provocar un funcionamiento erróneo. En el peor de los casos, podría provocar fugas de agua, descargas eléctricas, emisión de humo o incendios.
- No coloque un recipiente con agua, como un florero, sobre la unidad. Podría ingresar agua en la unidad y deteriorar el aislamiento eléctrico provocando descargas eléctricas.
- No lave los aparatos de aire acondicionado con lavadoras a presión. Las fugas eléctricas podrían causar descargas eléctricas o incendios.

(*1) Consulte la "Definición de instalador cualificado o persona de servicio cualificada".

■ Información sobre el transporte, el manejo y el almacenamiento de los embalajes de cartón

Ejemplos de indicaciones impresas en los embalajes de cartón

Símbolo	Descripción	Símbolo	Descripción
	Mantener seco		No dejar caer
	Frágil		No colocar tumbado
 11 cartons	Altura de apilamiento (En este caso se pueden apilar 12 embalajes de cartón)		No caminar sobre este embalaje de cartón
	Este lado hacia arriba		No pisar
	Manejar con cuidado		

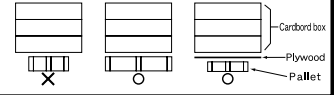
Otras precauciones	Descripción
 Caution Injury possibility. Don't handle with packing band, or may get injured in case of broken band.	PRECAUCIÓN Posibilidad de lesiones físicas. No lo maneje sujetándolo por las cintas de embalaje o podría sufrir lesiones físicas en caso de rotura de una cinta.
Stacking notice. In case that cardboard boxes protrude out of pallet when stacking, lay a 10mm thick plywood over the pallet. 	Aviso sobre apilamiento. Si las cajas de cartón sobresalen del pallet al apilarlas, coloque una madera contrachapada de 10 mm sobre el pallet.

Obrigado por ter adquirido este ar condicionado Toshiba.

Leia estas instruções com cuidado, pois contém informação importante que cumpre a Directiva "Máquinas" (Directiva 2006/42/CE), e assegure-se de que as entende.

Depois de ler estas instruções, certifique-se de que as guarda juntamente com o Manual do Proprietário e o Manual de Instalação fornecidos com o produto.

Denominação Genérica: Ar Condicionado





Definição de Instalador Qualificado ou de Técnico de Assistência Qualificado

O ar condicionado deve ser instalado, mantido, reparado e eliminado por um instalador qualificado ou um técnico de assistência qualificado. Quando for necessário efectuar qualquer um destes trabalhos, peça a um instalador qualificado ou a um técnico de assistência qualificado para efectuar estes trabalhos.

Um instalador qualificado ou um técnico de assistência qualificado é um agente com as qualificações e os conhecimentos descritos na tabela abaixo.

Agente	Qualificações e conhecimentos necessários do agente
Instalador qualificado	<ul style="list-style-type: none"> O instalador qualificado é uma pessoa que instala, dá manutenção a, muda de lugar e remove os ares condicionados fabricados pela Toshiba Carrier Corporation. Esta pessoa deve ter formação para instalar, dar manutenção a, mudar de lugar e remover ares condicionados fabricados pela Toshiba Carrier Corporation ou, como alternativa, deve ter sido instruída nessas operações por parte de indivíduos com a formação devida e, portanto, que adquiriram todo o conhecimento relacionado com estas operações. O instalador qualificado que tem permissão para levar a cabo as ligações eléctricas envolvidas na instalação, deslocação e remoção tem as qualificações necessárias para realizar essas tarefas conforme estipulado pelas leis e regulamentos locais, sendo uma pessoa que fez formação nas matérias relacionadas com trabalho eléctrico nos ares condicionados fabricados pela Toshiba Carrier Corporation ou, como alternativa, que foi instruída nessas matérias por parte de indivíduos com a formação devida e, portanto, que adquiriram todo o conhecimento relacionado com este trabalho. O instalador qualificado que tem permissão para realizar as tarefas de manuseamento do refrigerante e de instalação das tubagens envolvidas na instalação, deslocação e remoção dos aparelhos tem as qualificações necessárias para o manuseamento do refrigerante e a instalação das tubagens conforme estipulado pelas leis e regulamentos locais, sendo uma pessoa que fez formação nas matérias relacionadas com o manuseamento de refrigerante e a instalação de tubagens nos ares condicionados fabricados pela Toshiba Carrier Corporation ou, como alternativa, que foi instruída nessas matérias por parte de indivíduos com a formação devida e, portanto, que adquiriram todo o conhecimento relacionado com estas tarefas. O instalador qualificado, a quem é permitido trabalhar em altura, foi formado em matérias relacionadas com o trabalho em altura com ares condicionados fabricados pela Toshiba Carrier Corporation ou, como alternativa, foi instruído nessas matérias por indivíduos com a formação devida e, portanto, que adquiriram todo o conhecimento relacionado com este trabalho.
Técnico de assistência qualificado	<ul style="list-style-type: none"> O técnico de assistência qualificado é uma pessoa que instala, repara, dá manutenção a, muda de lugar e remove os ares condicionados fabricados pela Toshiba Carrier Corporation. Esta pessoa deve ter formação para instalar, reparar, dar manutenção a, mudar de lugar e remover ares condicionados fabricados pela Toshiba Carrier Corporation ou, como alternativa, deve ter sido instruído nessas operações por parte de indivíduos com a formação devida e, portanto, que adquiriram todo o conhecimento relacionado com estas operações. O técnico de assistência qualificado que tem permissão para levar a cabo as ligações eléctricas envolvidas na instalação, reparação, deslocação e remoção tem as qualificações necessárias para realizar essas tarefas conforme estipulado pelas leis e regulamentos locais, sendo uma pessoa que fez formação nas matérias relacionadas com trabalho eléctrico nos ares condicionados fabricados pela Toshiba Carrier Corporation ou, como alternativa, que foi instruída nessas matérias por parte de indivíduos com a formação devida e, portanto, que adquiriram todo o conhecimento relacionado com este trabalho. O técnico de assistência qualificado que tem permissão para realizar as tarefas de manuseamento do refrigerante e de instalação das tubagens envolvidas na instalação, reparação, deslocação e remoção dos aparelhos tem as qualificações necessárias para o manuseamento do refrigerante e a instalação das tubagens conforme estipulado pelas leis e regulamentos locais, sendo uma pessoa que fez formação nas matérias relacionadas com o manuseamento de refrigerante e a instalação de tubagens nos ares condicionados fabricados pela Toshiba Carrier Corporation ou, como alternativa, que foi instruída nessas matérias por parte de indivíduos com a formação devida e, portanto, que adquiriram todo o conhecimento relacionado com estas tarefas. O técnico de assistência qualificado, a quem é permitido trabalhar em altura, foi formado em matérias relacionadas com o trabalho em altura com ares condicionados fabricados pela Toshiba Carrier Corporation ou, como alternativa, foi instruído nessas matérias por indivíduos com a formação devida e, portanto, que adquiriram todo o conhecimento relacionado com este trabalho.

■ Indicações de aviso sobre o ar condicionado

Indicação de aviso	Descrição		
 <table border="1"> <tr> <td>WARNING</td> </tr> <tr> <td>ELECTRICAL SHOCK HAZARD Disconnect all remote electric power supplies before servicing.</td> </tr> </table>	WARNING	ELECTRICAL SHOCK HAZARD Disconnect all remote electric power supplies before servicing.	<p>ADVERTÊNCIAS</p> <p>PERIGO DE CHOQUE ELÉCTRICO Desligue todas as fontes de alimentação eléctrica remotas antes de uma operação de assistência.</p>
WARNING			
ELECTRICAL SHOCK HAZARD Disconnect all remote electric power supplies before servicing.			
 <table border="1"> <tr> <td>WARNING</td> </tr> <tr> <td>Moving parts. Do not operate unit with grille removed. Stop the unit before the servicing.</td> </tr> </table>	WARNING	Moving parts. Do not operate unit with grille removed. Stop the unit before the servicing.	<p>ADVERTÊNCIAS</p> <p>Peças rotativas. Não utilize a unidade com a grelha retirada. Pare a unidade antes de uma operação de assistência.</p>
WARNING			
Moving parts. Do not operate unit with grille removed. Stop the unit before the servicing.			
 <table border="1"> <tr> <td>CAUTION</td> </tr> <tr> <td>High temperature parts. You might get burned when removing this panel.</td> </tr> </table>	CAUTION	High temperature parts. You might get burned when removing this panel.	<p>PRECAUÇÃO</p> <p>Peças com elevadas temperaturas. Pode queimar-se quando retirar este painel.</p>
CAUTION			
High temperature parts. You might get burned when removing this panel.			
 <table border="1"> <tr> <td>CAUTION</td> </tr> <tr> <td>Do not touch the aluminum fins of the unit. Doing so may result in injury.</td> </tr> </table>	CAUTION	Do not touch the aluminum fins of the unit. Doing so may result in injury.	<p>PRECAUÇÃO</p> <p>Não toque nas palhetas de alumínio da unidade. Caso contrário, poderá ferir-se.</p>
CAUTION			
Do not touch the aluminum fins of the unit. Doing so may result in injury.			
 <table border="1"> <tr> <td>CAUTION</td> </tr> <tr> <td>BURST HAZARD Open the service valves before the operation, otherwise there might be the burst.</td> </tr> </table>	CAUTION	BURST HAZARD Open the service valves before the operation, otherwise there might be the burst.	<p>PRECAUÇÃO</p> <p>PERIGO DE EXPLOSÃO Abra as válvulas de serviço antes de utilizar o equipamento, caso contrário, pode ocorrer uma explosão.</p>
CAUTION			
BURST HAZARD Open the service valves before the operation, otherwise there might be the burst.			

1 Precauções de segurança

O fabricante não assumirá nenhuma responsabilidade por danos causados pela não observação das descrições dadas neste manual.

ADVERTÊNCIAS

Geral

- Leia atentamente o Manual do Proprietário antes de ligar o ar condicionado. Deverá ter em atenção alguns aspectos importantes para o funcionamento diário.
- Solicite a instalação ao revendedor ou a um instalador profissional. Somente um instalador qualificado (*1) é capaz de instalar um aparelho de ar condicionado. Se uma pessoa não qualificada instalar o ar condicionado, o aparelho pode criar problemas como fogo, choque eléctrico, ferimentos, vazamento de água, ruído e vibração.
- Não utilize um refrigerante diferente do especificado para complementação ou substituição. Caso contrário, uma pressão anormalmente alta pode ser gerada no ciclo de refrigeração, o que pode resultar numa falha ou explosão do produto ou em ferimentos pessoais.
- Lugares onde o som de funcionamento da unidade exterior possa causar perturbações. (Especialmente na linha de demarcação com um vizinho, instale o ar condicionado levando o ruído em consideração.)

Transporte e armazenamento

- Para transportar o aparelho de ar condicionado, utilize sapatos com protecção adicional para os dedos, luvas de protecção e outro vestuário de protecção.
- Para transportar o ar condicionado, não segure nas faixas existentes à volta da embalagem de cartão. Pode ferir-se, se as faixas se partirem.
- Antes de empilhar as embalagens de cartão para efeitos de armazenamento ou transporte, observe as precauções indicadas nas embalagens. Se não as respeitar, a pilha pode cair.
- O aparelho de ar condicionado deve ser transportado numa condição estável. Se encontrar qualquer parte do produto quebrada, contacte o seu revendedor.
- Se o aparelho de ar condicionado tiver que ser transportado manualmente, duas ou mais pessoas devem carregá-lo.

Instalação

- Apenas um instalador qualificado(*1) ou um técnico de assistência qualificado(*1) pode efectuar o trabalho eléctrico do ar condicionado. Este trabalho não deve ser efectuado por uma pessoa não qualificada em nenhuma circunstância porque um trabalho executado incorrectamente pode resultar em choques eléctricos e/ou fugas eléctricas.
- Terminado o trabalho de instalação, peça ao instalador que explique as posições do disjuntor. Em caso de ocorrência de algum tipo de problema no ar condicionado, coloque o disjuntor na posição desligada e contacte um técnico de assistência.
- Se instalar a unidade numa sala pequena, tome as medidas adequadas para evitar que o refrigerante exceda o limite de concentração mesmo em caso de vazamentos. Consulte o revendedor a quem adquiriu o ar condicionado quando implementar as medidas. A acumulação de refrigerante altamente concentrado pode provocar um acidente devido à falta de oxigénio.
- Não instale o ar condicionado num local sujeito a um risco de expiração de um gás combustível. Se ocorrer uma fuga de um gás combustível que se concentre à volta da unidade, pode ocorrer um incêndio.
- Utilize os produtos especificados pela companhia ao comprar peças separadamente. O uso de produtos não especificados pode resultar em incêndio, choque eléctrico, vazamento de água ou outros problemas. Solicite a instalação a um profissional.
- Certifique-se de que a conexão à terra seja realizada correctamente.

Funcionamento

- Antes de abrir a grelha de entrada da unidade interior ou painel de serviço da unidade exterior, coloque o disjuntor eléctrico na posição OFF. A não colocação do disjuntor eléctrico na posição OFF pode provocar choques eléctricos devido ao contacto com as peças internas. Apenas um instalador qualificado(*1) ou um técnico de assistência qualificado(*1) pode retirar a grelha de entrada da unidade interior ou o painel de serviço da unidade exterior e efectuar os trabalhos necessários.
- No interior do aparelho de ar condicionado, existem áreas de alta tensão e peças rotativas. Devido ao perigo de choque eléctrico ou de os seus dedos ou outros objectos ficarem entalados nas peças rotativas, não retire o painel de assistência técnica da unidade exterior. Quando for necessário realizar trabalho que implique a remoção destas peças, contacte um instalador qualificado ou um técnico de assistência qualificado.
- Não mova ou repare qualquer unidade. Uma vez que existe alta tensão no interior da unidade, pode sofrer um choque eléctrico aquando da remoção da tampa e da unidade principal.
- A utilização de um banco com mais de 50 cm de altura para limpar o filtro da unidade interior ou para realizar outras tarefas semelhantes constitui trabalho em altura. Devido ao perigo de cair do banco e de se magoar ao trabalhar em altura, este tipo de trabalho não deve ser feito por pessoas não qualificadas. Quando for necessário realizar este tipo de trabalho, não o faça você mesmo, mas peça a um instalador qualificado ou a um técnico de assistência qualificado que o faça por si.
- Não toque na palheta de alumínio da unidade exterior. Pode ferir-se, se o fizer. Se for necessário tocar na barbatana, não toque você mesmo, mas contacte um instalador qualificado ou um técnico de assistência qualificado.
- Não suba para nem coloque objectos sobre a unidade exterior. Pode cair ou os objectos podem cair da unidade exterior e provocar ferimentos.
- Não coloque nenhum aparelho de combustão num local exposto directamente ao vento do ar condicionado, caso contrário, pode provocar uma combustão imperfeita.
- Quando operar o aparelho de ar condicionado com um aparelho de combustão no mesmo lugar, ventile o ambiente suficientemente. Uma má ventilação pode diminuir o oxigénio.
- Quando o ar condicionado for utilizado(*1) quando a reparação incluir uma carga adicional de refrigerante. Uma má ventilação pode diminuir o oxigénio.
- Não exponha o seu corpo ao ar frio directamente durante um longo período de tempo e não se esfrie excessivamente.
Fazer isso pode deteriorar a sua condição física e afectar a sua saúde.
- Nunca insira os dedos ou um bastão na admissão ou descarga de ar.
- Fazer isso pode resultar em ferimentos, pois a ventoinha está a girar a alta velocidade dentro do aparelho.
- Consulte a loja onde comprou o ar condicionado se o seu funcionamento (arrefecimento e aquecimento) não estiver adequado, pois a causa pode ser o vazamento do refrigerante. Confirme os detalhes duma eventual reparação com um técnico de assistência qualificado(*1) quando a reparação incluir uma carga adicional de refrigerante.
- Certifique-se de desligar o ar condicionado e o disjuntor de circuito antes da limpeza.
Caso contrário, isso pode resultar em ferimentos, pois a ventoinha está a girar a alta velocidade dentro do aparelho.

Reparações

- Quando ocorrer algum tipo de problema (como, por exemplo, quando aparecer uma indicação de erro, cheiro a queimado, sons anormais, o ar condicionado não arrefecer ou aquecer, ou existir um vazamento de água) no aparelho de ar condicionado, não toque no ar condicionado, mas desligue (OFF) o disjuntor de circuito e contacte um técnico de assistência qualificado. Tome as medidas necessárias para garantir que a corrente eléctrica não será ligada (através da colocação do aviso "fora de serviço" junto ao disjuntor de serviço, por exemplo) até chegar o técnico de assistência qualificado. Se continuar a utilizar o ar condicionado com problemas, pode aumentar a ocorrência de problemas mecânicos e provocar choques eléctricos ou outros problemas.
- Se a grelha da ventoinha estiver danificada, não se aproxime da unidade exterior, mas desligue (OFF) o disjuntor de circuito e contacte um técnico de assistência qualificado para proceder à reparação. Não coloque o disjuntor eléctrico na posição ON até ao fim das reparações.
- Se houver o risco de queda da unidade interior, não se aproxime da unidade interior, mas desligue (OFF) o disjuntor de circuito e contacte um instalador qualificado ou um técnico de assistência qualificado para voltar a instalar a unidade. Não coloque o disjuntor na posição ligada enquanto a reinstalação não estiver concluída.
- Se houver o risco de tombamento da unidade exterior, não se aproxime da unidade exterior, mas desligue (OFF) o disjuntor de circuito e contacte um instalador qualificado ou um técnico de assistência qualificado para fazer os devidos ajustes ou voltar a instalar a unidade. Não coloque o disjuntor na posição ligada enquanto os ajustes ou a reinstalação não estiverem concluídos.
- Não tente personalizar o aparelho. Fazer isso pode resultar em incêndio, choque eléctrico ou outros problemas.

Mudança

- Se tiver de mudar o ar condicionado de lugar, não o faça você mesmo, mas contacte um instalador qualificado ou um técnico de assistência qualificado. Se não deslocar o ar condicionado como deve ser, pode dar origem a choque eléctrico e/ou incêndio.

⚠️ PRECAUÇÃO

Para desconectar o aparelho da fonte de alimentação principal.

- Este aparelho tem de ser ligado à rede eléctrica através de um interruptor com uma separação de contacto de pelo menos 3 mm.

Deve utilizar um fusível de instalação (qualquer tipo pode ser utilizado) para a linha de fornecimento de energia deste aparelho de ar condicionado.

Instalação

- Instale o tubo de drenagem para uma drenagem correcta. Uma drenagem inadequada pode causar inundações na casa e molhar a mobília.
- Conecte o aparelho de ar condicionado a um fornecimento de energia exclusivo com a voltagem indicada, caso contrário a unidade poderá avariar-se ou provocar um incêndio.
- Certifique-se de que a unidade exterior esteja fixada na base. Caso contrário, podem ocorrer acidentes como a queda das unidades ou outros problemas.









Funcionamento

- Não utilize este ar condicionado para fins especiais, tais como conservação de alimentos, instrumentos de precisão, objectos de arte, criação de animais de estimação, carro, embarcação, etc.
- Não toque nos interruptores com o dedo molhado, caso contrário pode apanhar um choque eléctrico.
- Caso o ar condicionado não seja utilizado durante um longo período de tempo, desligue o interruptor principal ou o disjuntor para segurança.
- Para fazer com que o ar condicionado funcione tal como previsto, opere-o dentro do nível de temperatura especificado nas instruções. Caso contrário, pode causar avarias ou derrames de águas na unidade.
- Evite o derrame de qualquer líquido para dentro do controlador remoto. Não derrame sumo, água ou qualquer líquido.
- Não lave o ar condicionado. Fazer isso pode resultar em choques eléctricos.
- Verifique se a base de instalação e outros equipamentos não sofreram deteriorações após a utilização durante um longo período de tempo. Deixá-los em más condições pode resultar na queda da unidade e provocar ferimentos.
- Não deixe sprays inflamáveis ou outros materiais inflamáveis perto do ar condicionado, e não borrife um aerossol inflamável directamente sobre o ar condicionado. Isso pode causar um incêndio.
- Certifique-se de desligar o ar condicionado e o disjuntor de circuito antes da limpeza. Caso contrário, isso pode resultar em ferimentos, pois a ventoinha está a girar a alta velocidade dentro do aparelho.
- Solicite a limpeza do ar condicionado ao revendedor.
- Limpar o ar condicionado de maneira inadequada pode causar danos às partes de plástico, falha de isolamento das peças eléctricas ou outras peças, e resultar num mau funcionamento. No pior dos casos, isso pode resultar em vazamento de água, choque eléctrico, emissão de fumaça ou incêndio.
- Não coloque um recipiente de água como um vaso, por exemplo, sobre o aparelho. A água pode infiltrar-se no aparelho e isso pode causar a deterioração do isolamento eléctrico e resultar em choques eléctricos.
- Não lave condicionadores de ar com máquinas de lavar a pressão. As fugas eléctricas podem provocar choques eléctricos ou incêndios.

(*1) Consulte a "Definição de Instalador Qualificado ou de Técnico de Assistência Qualificado".

■ Informações sobre o transporte, manuseamento e armazenamento da embalagem de cartão

Exemplos de indicações na embalagem de cartão

Símbolo	Descrição	Símbolo	Descrição
	Manter seco		Não deixar cair
	Frágil		Não deitar na horizontal
	Altura de empilhamento (12 embalagens podem ser empilhadas neste caso)		Não andar sobre esta embalagem
	Este lado para cima		Não pisar
	Manusear com cuidado		

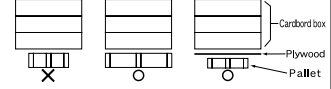
Outras precauções	Descrição
 Caution Injury possibility. Don't handle with packing band, or may get injured in case of broken band.	PRECAUÇÃO Possibilidade de se magoar. Não pegue pela fita de embalagem, pois pode magoar-se se a fita se partir.
Stacking notice. In case that cardboard boxes protrude out of pallet when stacking, lay a 10mm thick plywood over the pallet. 	Aviso de empilhamento. Se as embalagens ultrapassarem a palete quando empilhadas, coloque um contraplacado de 10 mm de espessura em cima da palete.

Hartelijk dank voor uw aankoop van deze Toshiba-airconditioner.

Lees deze instructies zorgvuldig. Ze bevatten informatie die voldoet aan de richtlijn voor "Machines" (richtlijn 2006/42/EC). Zorg dat u de instructies begrijpt.

Na het doorlezen van deze instructies dient u ze te bewaren op een veilige plaats, samen met de eigenaarshandleiding en de installatiehandleiding die bij uw product zijn geleverd.

Algemene beschrijving: Airconditioner





Definitie van bevoegd installateur of bevoegd onderhoudsmonteur

De airconditioner moet worden geïnstalleerd, onderhouden, gerepareerd en uiteindelijk weggedaan door een bevoegd installateur of bevoegd onderhoudsmonteur. Wanneer een van deze taken verricht moet worden, verzoekt u dan een bevoegd installateur of bevoegd onderhoudsmonteur om dit voor u te doen.

Een bevoegd installateur of bevoegd onderhoudsmonteur is een persoon die beschikt over de kennis en bevoegdheden die staan vermeld in de onderstaande tabel.

Persoon	Kennis en bevoegdheden waarover de persoon moet beschikken
Bevoegd installateur	<ul style="list-style-type: none"> De bevoegde installateur is een persoon die door Toshiba Carrier Corporation gemaakte airconditioners installeert, onderhoudt, verplaatst en verwijderd. Hij of zij is opgeleid om door Toshiba Carrier Corporation gemaakte airconditioners te installeren, onderhouden, verplaatsen en te verwijderen. Deze persoon kan ook iemand zijn die in dergelijke taken is geïnstrueerd door een persoon of personen die zijn opgeleid en is dus goed op de hoogte van de kennis voor deze taken. De bevoegde installateur die bevoegd is om het elektrische gedeelte van de installatie, verplaatsing en verwijdering op zich te nemen beschikt over de kwalificaties voor deze elektrische werkzaamheden zoals voorzien in plaatselijke wetten en regelgeving. Deze persoon is opgeleid voor koel- en elektrische systemen van de airconditioners gemaakt door Toshiba Carrier Corporation. Deze persoon kan ook iemand zijn die in dergelijke taken is geïnstrueerd door een persoon of personen die zijn opgeleid en is dus goed op de hoogte van de kennis voor dit soort werk. De bevoegde installateur die bevoegd is om het koel- en leidingenwerk van de installatie, verplaatsing en verwijdering op zich te nemen beschikt over de kwalificaties voor deze koel- en leidingenwerkzaamheden zoals voorzien in plaatselijke wetten en regelgeving. Deze persoon is opgeleid voor koel- en leidingenwerkzaamheden aan de airconditioners gemaakt door Toshiba Carrier Corporation. Deze persoon kan ook iemand zijn die in dergelijke taken is geïnstrueerd door een persoon of personen die zijn opgeleid en is dus goed op de hoogte van de kennis voor dit soort werk. De bevoegde installateur die bevoegd is om op hoogte te werken is opgeleid om op hoogten te werken met airconditioners gemaakt door Toshiba Carrier Corporation. Deze persoon kan ook iemand zijn die in dergelijke taken is geïnstrueerd door een persoon of personen die zijn opgeleid en is dus goed op de hoogte van de kennis voor dit soort werk.
Bevoegd onderhoudsmonteur	<ul style="list-style-type: none"> De bevoegde onderhoudspersoon is een persoon die door Toshiba Carrier Corporation gemaakte airconditioners installeert, repareert, onderhoudt, verplaatst en verwijderd. Hij of zij is opgeleid om door Toshiba Carrier Corporation gemaakte airconditioners te installeren, repareren, onderhouden, verplaatsen en te verwijderen. Deze persoon kan ook iemand zijn die in dergelijke taken is geïnstrueerd door een persoon of personen die zijn opgeleid en is dus goed op de hoogte van de kennis voor deze taken. De bevoegde onderhoudspersoon die bevoegd is om het elektrische gedeelte van de installatie, reparatie, verplaatsing en verwijdering op zich te nemen beschikt over de kwalificaties voor deze elektrische werkzaamheden zoals voorzien in plaatselijke wetten en regelgeving. Deze persoon is opgeleid voor werkzaamheden aan het elektrische systeem van de airconditioners gemaakt door Toshiba Carrier Corporation. Deze persoon kan ook iemand zijn die in dergelijke taken is geïnstrueerd door een persoon of personen die zijn opgeleid en is dus goed op de hoogte van de kennis voor dit soort werk. De bevoegde installateur die bevoegd is om het koel- en leidingenwerk van de installatie, reparatie, verplaatsing en verwijdering op zich te nemen beschikt over de kwalificaties voor deze koel- en leidingenwerkzaamheden zoals voorzien in plaatselijke wetten en regelgeving. Deze persoon is opgeleid voor koel- en leidingenwerkzaamheden aan de airconditioners gemaakt door Toshiba Carrier Corporation. Deze persoon kan ook iemand zijn die in dergelijke taken is geïnstrueerd door een persoon of personen die zijn opgeleid en is dus goed op de hoogte van de kennis voor dit soort werk. De bevoegde onderhoudspersoon die bevoegd is om op hoogte te werken is opgeleid om op hoogten te werken met airconditioners gemaakt door Toshiba Carrier Corporation. Deze persoon kan ook iemand zijn die in dergelijke taken is geïnstrueerd door een persoon of personen die zijn opgeleid en is dus goed op de hoogte van de kennis voor dit soort werk.

■ Waarschuwingsaanduidingen op de airconditioner

Waarschuwingsaanduiding	Beschrijving		
 <table border="1"> <tr> <td>WARNING</td> </tr> <tr> <td>ELECTRICAL SHOCK HAZARD Disconnect all remote electric power supplies before servicing.</td> </tr> </table>	WARNING	ELECTRICAL SHOCK HAZARD Disconnect all remote electric power supplies before servicing.	<p>WAARSCHUWING</p> <p>GEVAAR VOOR ELEKTRISCHE SCHOK Verbreek alle externe stroomvoorzieningsaansluitingen alvorens enig onderhoud te verrichten.</p>
WARNING			
ELECTRICAL SHOCK HAZARD Disconnect all remote electric power supplies before servicing.			
 <table border="1"> <tr> <td>WARNING</td> </tr> <tr> <td>Moving parts. Do not operate unit with grille removed. Stop the unit before the servicing.</td> </tr> </table>	WARNING	Moving parts. Do not operate unit with grille removed. Stop the unit before the servicing.	<p>WAARSCHUWING</p> <p>Bewegende delen. Schakel het apparaat niet in wanneer het voorrooster is verwijderd. Stop de werking van het apparaat alvorens enig onderhoud te verrichten.</p>
WARNING			
Moving parts. Do not operate unit with grille removed. Stop the unit before the servicing.			
 <table border="1"> <tr> <td>CAUTION</td> </tr> <tr> <td>High temperature parts. You might get burned when removing this panel.</td> </tr> </table>	CAUTION	High temperature parts. You might get burned when removing this panel.	<p>VOORZICHTIG</p> <p>Delen met hoge temperaturen. Bij het verwijderen van dit paneel is bestaan de kans dat u zich brandt.</p>
CAUTION			
High temperature parts. You might get burned when removing this panel.			
 <table border="1"> <tr> <td>CAUTION</td> </tr> <tr> <td>Do not touch the aluminum fins of the unit. Doing so may result in injury.</td> </tr> </table>	CAUTION	Do not touch the aluminum fins of the unit. Doing so may result in injury.	<p>VOORZICHTIG</p> <p>Raak de aluminium koelvinnen van het apparaat niet aan. Dat zou tot ernstige verwondingen kunnen leiden.</p>
CAUTION			
Do not touch the aluminum fins of the unit. Doing so may result in injury.			
 <table border="1"> <tr> <td>CAUTION</td> </tr> <tr> <td>BURST HAZARD Open the service valves before the operation, otherwise there might be the burst.</td> </tr> </table>	CAUTION	BURST HAZARD Open the service valves before the operation, otherwise there might be the burst.	<p>VOORZICHTIG</p> <p>GEVAAR VOOR UITBARSTING Open voor enige ingreep eerst de veiligheidskleppen, anders kan er een uitbarsting volgen.</p>
CAUTION			
BURST HAZARD Open the service valves before the operation, otherwise there might be the burst.			

1 Voorzorgen voor de veiligheid

De fabrikant is niet aansprakelijk voor schade ten gevolge van het niet opvolgen van aanwijzingen in deze handleiding.

WAARSCHUWING

Algemeen

- Lees de gebruikershandleiding aandachtig voordat u de airconditioner gebruikt. Voor dagelijks gebruik zijn er een groot aantal belangrijke aandachtspunten.
- Laat het installeren over aan de plaats van aankoop of een vakman. De airconditioner mag uitsluitend door een erkend installateur (*1) worden gemonteerd. U krijgt diverse problemen als brand, elektrische schokken, letsel, waterlekkage, ruis en trilling indien de airconditioner door een onbevoegd persoon wordt gemonteerd.
- Gebruik voor het bijvullen of vervangen geen ander koelmiddel dan het gespecificeerde middel. Er wordt anders namelijk mogelijk abnormale hoge druk in de koelcyclus opgebouwd met een onjuiste werking, ontploffing of lichamelijk letsel als gevolg.
- Plaatsen waar het bedrijfsgeluid van de buitenunit storend kan zijn. (Let bij het installeren vooral op dat eventuele burenen geen last van het bedrijfsgeluid van de airconditioner kunnen hebben.)

Transport en opslag

- Draag beschermende werkschoenen, handschoenen en andere geschikte werkkleding voor het vervoeren van de airconditioner.
- Bij het vervoeren van de airconditioner mag u die niet optillen aan de banden rond de verpakkingsdoos. Als de banden zouden breken, loopt u de kans op verwondingen.
- Houd u bij het opstapelen van de kartonnen verpakkingen voor opslag of transport aan de waarschuwingen op de verpakkingen. Als u dit niet doet kan de stapel instorten.
- De airconditioner moet stabiel worden getransporteerd. Neem direct contact op met de plaats van aankoop indien onderdelen beschadigd zijn.
- Draag de airconditioner altijd met minimaal 2 personen indien deze met de hand moet worden verplaatst.

Installeren

- Alleen een bevoegd installateur(*1) of een bevoegd onderhoudsmonteur(*1) mag elektrische werkzaamheden aan de airconditioner verrichten. Onder geen voorwaarde mag dit werk worden verricht door een onbevoegde, aangezien fouten of vergissingen kunnen leiden tot elektrische schokken en/of kortsluiting of lekstroom.
- Vraag de installateur na installatie om uitleg over de standen van de stroomonderbreker. Als er problemen optreden in de airconditioner, zet de stroomonderbreker op de positie OFF (UIT) en neem contact op met bevoegd onderhoudspersoneel.
- Als u de unit installeert in een kleine kamer, dient u maatregelen te treffen om bij lekkage van koelmiddel in elk geval te zorgen dat de limiet voor concentratie van koelmiddel in de kamer niet wordt overschreden. Raadpleeg de dealer van wie u de airconditioner hebt gekocht voor nader advies over de maatregelen. Als er zich sterk geconcentreerd koelmiddel ophoopt, kan dat ongelukken door zuurstofgebrek veroorzaken.
- Installeer de airconditioner niet op een plaats waar brandbare gassen vrijkomen, i.v.m. ontploffingsgevaar. Als er brandbaar gas lekt en zich ophoopt rondom de eenheid, kan er brand ontstaan.
- Gebruik beslist uitsluitend de door de fabrikant gespecificeerde, los verkrijgbare producten en onderdelen. Het gebruik van niet-gespecificeerde onderdelen en producten kan brand, elektrische schokken, waterlekkage, etc. veroorzaken. Laat het installeren beslist over aan een vakman.
- Verzekert dat de aarding juist is.

Bereik

- Voordat u het inlaatrooster van de binneneenheid of het onderhoudspaneel van de buiteneenheid opent, zet u eerst de stroomonderbreker in de OFF-stand. Als u verzuimt de stroomonderbreker in de OFF-stand te zetten, loopt u de kans op een elektrische schok bij aanraken van de inwendige onderdelen. Alleen een bevoegd installateur(*1) of een bevoegd onderhoudsmonteur(*1) mag het inlaatrooster van de binneneenheid of het onderhoudspaneel van de buiteneenheid verwijderen en het vereiste werk verrichten.
- De airconditioner bevat ruimtes die onder hoge spanning staan en draaiende onderdelen. Het onderhoudspaneel van de buitenunit niet verwijderen vanwege gevaar van elektrische schokken. Uw vingers of andere voorwerpen zouden daarbij beklemd kunnen raken in de draaiende onderdelen. Als deze onderdelen moeten worden verwijderd, neem dan contact op met een bevoegde installateur of bevoegd onderhoudspersoon.
- Verplaats of herstel het apparaat niet zelf. Omdat er onderdelen met hoogspanning in het apparaat aanwezig zijn, loopt u gevaar voor elektrische schokken wanneer u de behuizing van de hoofdunit verwijdert.
- Gebruik een platform van minstens 50 cm hoog om het filter van de binnenunit te reinigen of soortgelijke taken op hoogte uit te voeren. Dit werk mag alleen door bevoegde personen worden uitgevoerd vanwege de kans dat u kunt vallen en letsel op kunt lopen. Als dit soort werk moet worden uitgevoerd, neem dan contact op met een bevoegde installateur of bevoegd onderhoudspersoon om dit werk voor u te doen.
- Raak de aluminium koelvinnen van de buiteneenheid niet aan. Anders zou u zich er aan kunnen verwonden. Als u de vin toch moet aanraken, maar neem contact op met een bevoegde installateur of bevoegd onderhoudspersoon.
- Plaats nooit voorwerpen op de buiteneenheid en klim er niet bovenop. U zou er af kunnen vallen of een voorwerp kan van de buiteneenheid af vallen en letsel veroorzaken.
- Zet geen verbrandingsapparaat op een plaats waar het in de directe luchtstroom van de airconditioner staat, anders kan er onvolledige verbranding plaatsvinden.
- Indien de airconditioner in dezelfde ruimte met verbrandingsapparatuur wordt gebruikt, moet u de ruimte goed ventileren. Door slechte ventilatie ontstaat een zuurstoftekort.
- Zorg voor voldoende ventilatie wanneer de airconditioner wordt gebruikt in een afgesloten ruimte. Door slechte ventilatie ontstaat een zuurstoftekort.
- Ga niet te lang in de directe koude luchtstroom staan en zorg dat personen niet te koud worden. Dit zou namelijk ziekte en een verslechterde lichamelijke conditie veroorzaken.
- Steek geen vingers of andere voorwerpen in de luchtinlaat of -uitlaat. De ventilator roteert namelijk met hoge snelheid in de unit.
- Raadpleeg de plaats van aankoop indien de airconditioner onjuist functioneert (koelen en verwarmen). Lekkend koelmiddel zou namelijk het geval kunnen zijn. Bevestig de reparatiedetails met erkend onderhoudspersoneel (*1) indien er bij de reparatie extra koelmiddel werd toegevoegd.
- Stop de airconditioner alvorens te reinigen beslist en schakel de circuitonderbreker uit. De ventilator roteert namelijk met hoge snelheid in de unit en u zou anders ongelukken kunnen krijgen.

Reparaties

- Indien er iets mis is met de airconditioner (wanneer u een foutmelding ziet of een brandlucht ruikt, vreemde geluiden hoort, de airconditioner niet koelt of verwarmt, of wanneer er water uit lekt), raak dan de airconditioner niet aan maar zet de circuitonderbreker in de OFF-stand en neem contact op met een bevoegd onderhoudsmonteur. Neem de nodige maatregelen om te voorkomen dat het apparaat wordt ingeschakeld (schrijf bijvoorbeeld "defect" dichtbij de stroomonderbreker e.d.) totdat de bevoegde onderhoudsmonteur arriveert. Het voortzetten van het gebruik van de airconditioner terwijl er iets mis mee is, kan leiden tot ernstige mechanische defecten, elektrische schokken en andere problemen.
- Indien het ventilatorrooster is beschadigd, raak dan de buitenunit niet aan maar zet de circuitonderbreker in de OFF-stand en verzoek een bevoegd onderhoudsmonteur om reparatie. Zet de stroomonderbreker niet terug in de ON-stand totdat alle vereiste reparaties zijn voltooid.
- Indien de binnenunit zou kunnen vallen, blijf dan uit de buurt van de unit, zet de circuitonderbreker in de OFF-stand en neem contact op met bevoegd onderhoudspersoneel om de unit opnieuw goed te installeren. Zet de stroomonderbreker niet op de positie ON (AAN) voordat de unit opnieuw is geplaatst.
- Indien de buitenunit zou kunnen vallen, blijf dan uit de buurt van de unit, zet de circuitonderbreker in de OFF-stand en neem contact op met een bevoegde installateur of bevoegd onderhoudspersoneel om de unit opnieuw en goed te installeren. Zet de stroomonderbreker niet op de positie ON (AAN) voordat de werkzaamheden zijn voltooid.
- Breng geen wijzigingen in de unit aan. Dit zou namelijk brand, elektrische schokken en andere problemen kunnen veroorzaken.

Elders opstellen

- Als u de airconditioner moet verplaatsen, doe dit niet zelf maar neem contact op met een bevoegde installateur of bevoegd onderhoudspersoon. Incorrect verplaatsen van de airconditioner kan leiden tot elektrische schokken en/of vuur.

VOORZICHTIG

Het apparaat loskoppelen van de netvoeding.

- Dit apparaat moet verbonden worden met de netvoeding via een schakelaar met een contactscheiding van ten minste 3 mm.

De stroomtoevoer van de airconditioner moet voorzien zijn van een installatiezekering (alle types zekeringen kunnen gebruikt worden).

Installeren

- Zorg ervoor dat de afvoerslang het water goed afvoert. Een onjuiste afvoer kan overstroming en waterschade aan het meubilair, etc. veroorzaken.
- Sluit de airconditioner altijd aan op een exclusieve stroombron van het juiste, aangegeven voltage. Dit nalaten kan beschadiging van de unit en brand veroorzaken.
- Controleer dat de buitenunit goed op de basis is vergrendeld. De unit zou anders kunnen vallen en ongelukken veroorzaken.









Bereik

- Gebruik deze airconditioner niet voor speciale doeleinden, zoals het conserveren van voedsel, precisie-instrumenten, kunstobjecten, bij het fokken van dieren, in een auto of vaartuig.
- Raak schakelaars nooit aan met natte vingers, omdat daardoor gevaar voor elektrische schokken kan ontstaan.
- Indien de airconditioner voor afzienbare tijd niet wordt gebruikt, is het veiliger de hoofdschakelaar of stroomonderbreker uit te schakelen.
- Om de airconditioner optimaal te laten functioneren, gebruikt u het toestel altijd binnen de gebruikstemperaturen die in de handleiding vermeld zijn. Zo niet kan een defect of een waterlek ontstaan in het toestel.
- Zorg dat er geen vloeistof in de afstandsbediening terecht komt. Mors geen vruchtensap, water of andere vloeistoffen.
- Was de airconditioner niet. Dit zou namelijk een elektrische schok kunnen geven.
- Controleer na verloop van tijd dat de installatiebasis en andere apparatuur niet zijn versleten of beschadigd. De unit zou namelijk kunnen vallen met ongelukken als gevolg indien gerelateerde onderdelen zijn beschadigd.
- Zorg dat er geen ontvlambare spray's of materialen in de buurt van de airconditioner zijn en spuit geen ontvlambare middelen direct naar de airconditioner. Dit soort middelen kan namelijk brand veroorzaken.
- Stop de airconditioner alvorens te reinigen beslist en schakel de circuitonderbreker uit.
- De ventilator roteert namelijk met hoge snelheid in de unit en u zou anders ongelukken kunnen krijgen.
- Laat het reinigen van de airconditioner over aan de plaats van aankoop.
- Het verkeerd reinigen van de airconditioner kan plastic onderdelen beschadigen, de isolatie van elektrische onderdelen of andere onderdelen beschadigen en een onjuiste werking veroorzaken. In het ergste geval veroorzaakt dit waterlekage, elektrische schokken, rookontwikkeling of brand.
- Plaats geen vloeistoffen, bijvoorbeeld bloemenvazen op de unit.
- Er zou anders namelijk water of vloeistof in de unit kunnen komen waardoor de elektrische isolatie wordt aangetast met mogelijk elektrische schokken als gevolg.
- Was airconditioners niet met hogedrukreinigers.
- Elektrische lekkages kunnen elektrische schokken of brand veroorzaken.

(*1) Zie de "Definitie van bevoegd installateur of bevoegd onderhoudsmonteur".

■ Informatie over transport, hanteren en opslaan van de verpakking

Voorbeelden van aanduidingen op de verpakking

Symbol	Beschrijving	Symbol	Beschrijving
	Droog houden		Niet laten vallen
	Breekbaar		Niet neerleggen
 11 cartons	Stapelhoogte (in dit geval kunnen 12 kartonnen dozen worden gestapeld)		Niet op deze verpakking lopen
	Deze zijde naar boven		Niet op staan
	Voorzichtig behandelen		

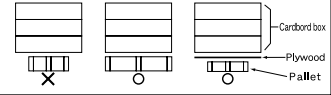
Overige waarschuwingen	Beschrijving
 <div style="border: 1px solid black; padding: 5px; display: inline-block;"> <p>Caution Injury possibility. Don't handle with packing band, or may get injured in case of broken band.</p> </div>	<p>VOORZICHTIG</p> <p>Kans op verwondingen. Niet oppakken aan de verpakingsband vanwege gevaar voor verwondingen bij een gebroken band.</p>
<p>Stacking notice.</p> <p>In case that cardboard boxes protrude out of pallet when stacking, lay a 10mm thick plywood over the pallet.</p> 	<p>Stapelmelding.</p> <p>In geval de kartonnen dozen uit de pallet steken bij het stapelen. Leg een triplexlaag van 10 mm over de pallet.</p>

Σας ευχαριστούμε για την αγορά αυτού του κλιματιστικού Toshiba.
 Διαβάστε προσεκτικά αυτές τις οδηγίες που περιλαμβάνουν σημαντικές πληροφορίες που συμμορφώνονται με την Οδηγία σχετικά με τα μηχανήματα (Οδηγία 2006/42/EK) και βεβαιωθείτε ότι τις κατανοείτε.
 Όταν διαβάσετε αυτές τις οδηγίες, φροντίστε να τις φυλάξετε σε ασφαλές μέρος μαζί με το Εγχειρίδιο Κατόχου και το Εγχειρίδιο Εγκατάστασης τα οποία παρέχονται με το προϊόν σας.

Γενικός χαρακτηρισμός: Κλιματιστική μονάδα





Ορισμός Εξειδικευμένου Εγκαταστάτη ή Εξειδικευμένου Τεχνικού Σέρβις

Απαιτείται εγκατάσταση, συντήρηση, επισκευή και απόρριψη του κλιματιστικού από εξειδικευμένο εγκαταστάτη ή εξειδικευμένο τεχνικό σέρβις. Όταν απαιτείται εκτέλεση οποιασδήποτε από τις συγκεκριμένες εργασίες, αναθέστε την εκτέλεσή της σε εξειδικευμένο εγκαταστάτη ή εξειδικευμένο τεχνικό σέρβις.

Ένας εξειδικευμένος εγκαταστάτης ή εξειδικευμένος τεχνικός σέρβις είναι αντιπρόσωπος ο οποίος διαθέτει τα προσόντα και τις γνώσεις που περιγράφονται στον πίνακα κατωτέρω.

Αντιπρόσωπος	Προσόντα και γνώσεις τα οποία απαιτείται να διαθέτει ο αντιπρόσωπος
Εξειδικευμένος εγκαταστάτης	<ul style="list-style-type: none"> Ο εξειδικευμένος εγκαταστάτης είναι ένα άτομο που πραγματοποιεί εργασίες εγκατάστασης, συντήρησης, αλλαγής θέσης και αφαίρεσης των κλιματιστικών που κατασκευάζει η Toshiba Carrier Corporation. Το άτομο αυτό έχει εκπαιδευτεί στην εγκατάσταση, συντήρηση, αλλαγή θέσης και αφαίρεση των κλιματιστικών που κατασκευάζει η Toshiba Carrier Corporation ή, εναλλακτικά, έχει διδαχθεί αυτές τις εργασίες από άτομα που έχουν εκπαιδευτεί και είναι επομένως πλήρως εξοικειωμένοι με τις γνώσεις που σχετίζονται με αυτές τις εργασίες. Ο εξειδικευμένος εγκαταστάτης που επιτρέπεται να κάνει τις ηλεκτρικές εργασίες που σχετίζονται με την εγκατάσταση, αλλαγή θέσης και αφαίρεση, διαθέτει τα προσόντα που σχετίζονται με αυτές τις ηλεκτρικές εργασίες όπως ορίζεται από τους τοπικούς νόμους και κανονισμούς, και είναι άτομο που έχει εκπαιδευτεί σε θέματα που σχετίζονται με τις ηλεκτρικές εργασίες σε κλιματιστικά που κατασκευάζονται από την Toshiba Carrier Corporation ή, εναλλακτικά, έχει διδαχθεί αυτές τις εργασίες από άτομα που έχουν εκπαιδευτεί και, επομένως, είναι πλήρως εξοικειωμένοι με τις γνώσεις που σχετίζονται με αυτές τις εργασίες. Ο εξειδικευμένος εγκαταστάτης που επιτρέπεται να χειρίζεται το ψυκτικό και να εκτελεί τις εργασίες σωλήνωσης που σχετίζονται με την εγκατάσταση, αλλαγή θέσης και αφαίρεση, διαθέτει τα προσόντα που σχετίζονται με αυτές τις εργασίες χειρισμού του ψυκτικού και τις εργασίες σωλήνωσης όπως ορίζεται από τους τοπικούς νόμους και κανονισμούς, και είναι άτομο που έχει εκπαιδευτεί σε θέματα που σχετίζονται με τις εργασίες χειρισμού του ψυκτικού και τις εργασίες σωλήνωσης σε κλιματιστικά που κατασκευάζονται από την Toshiba Carrier Corporation ή, εναλλακτικά, έχει διδαχθεί αυτές τις εργασίες από άτομα που έχουν εκπαιδευτεί και, επομένως, είναι πλήρως εξοικειωμένοι με τις γνώσεις που σχετίζονται με αυτές τις εργασίες. Ο εξειδικευμένος εγκαταστάτης που επιτρέπεται να εργάζεται σε ύψη έχει εκπαιδευτεί σε θέματα που σχετίζονται με τις εργασίες σε ύψη με κλιματιστικά που κατασκευάζονται από την Toshiba Carrier Corporation ή, εναλλακτικά, έχει διδαχθεί αυτές τις εργασίες από άτομα που έχουν εκπαιδευτεί και, επομένως, είναι πλήρως εξοικειωμένοι με τις γνώσεις που σχετίζονται με αυτές τις εργασίες.
Εξειδικευμένος τεχνικός σέρβις	<ul style="list-style-type: none"> Ο εξειδικευμένος τεχνικός επισκευών είναι ένα άτομο που πραγματοποιεί εργασίες εγκατάστασης, επισκευής, συντήρησης, αλλαγής θέσης και αφαίρεσης των κλιματιστικών που κατασκευάζει η Toshiba Carrier Corporation. Το άτομο αυτό έχει εκπαιδευτεί στην εγκατάσταση, επισκευή, συντήρηση, αλλαγή θέσης και αφαίρεση των κλιματιστικών που κατασκευάζει η Toshiba Carrier Corporation ή, εναλλακτικά, έχει διδαχθεί αυτές τις εργασίες από άτομα που έχουν εκπαιδευτεί και είναι επομένως πλήρως εξοικειωμένοι με τις γνώσεις που σχετίζονται με αυτές τις εργασίες. Ο εξειδικευμένος τεχνικός επισκευών που επιτρέπεται να κάνει τις ηλεκτρικές εργασίες που σχετίζονται με την εγκατάσταση, επισκευή, αλλαγή θέσης και αφαίρεση, διαθέτει τα προσόντα που σχετίζονται με αυτές τις ηλεκτρικές εργασίες όπως ορίζεται από τους τοπικούς νόμους και κανονισμούς, και είναι άτομο που έχει εκπαιδευτεί σε θέματα που σχετίζονται με τις ηλεκτρικές εργασίες σε κλιματιστικά που κατασκευάζονται από την Toshiba Carrier Corporation ή, εναλλακτικά, έχει διδαχθεί αυτές τις εργασίες από άτομα που έχουν εκπαιδευτεί και, επομένως, είναι πλήρως εξοικειωμένοι με τις γνώσεις που σχετίζονται με αυτές τις εργασίες. Ο εξειδικευμένος τεχνικός επισκευών που επιτρέπεται να χειρίζεται το ψυκτικό και να εκτελεί τις εργασίες σωλήνωσης που σχετίζονται με την εγκατάσταση, επισκευή, αλλαγή θέσης και αφαίρεση, διαθέτει τα προσόντα που σχετίζονται με αυτές τις εργασίες χειρισμού του ψυκτικού και τις εργασίες σωλήνωσης όπως ορίζεται από τους τοπικούς νόμους και κανονισμούς, και είναι άτομο που έχει εκπαιδευτεί σε θέματα που σχετίζονται με τις εργασίες χειρισμού του ψυκτικού και τις εργασίες σωλήνωσης σε κλιματιστικά που κατασκευάζονται από την Toshiba Carrier Corporation ή, εναλλακτικά, έχει διδαχθεί αυτές τις εργασίες από άτομα που έχουν εκπαιδευτεί και, επομένως, είναι πλήρως εξοικειωμένοι με τις γνώσεις που σχετίζονται με αυτές τις εργασίες. Ο εξειδικευμένος τεχνικός επισκευών που επιτρέπεται να εργάζεται σε ύψη έχει εκπαιδευτεί σε θέματα που σχετίζονται με τις εργασίες σε ύψη με κλιματιστικά που κατασκευάζονται από την Toshiba Carrier Corporation ή, εναλλακτικά, έχει διδαχθεί αυτές τις εργασίες από άτομα που έχουν εκπαιδευτεί και, επομένως, είναι πλήρως εξοικειωμένοι με τις γνώσεις που σχετίζονται με αυτές τις εργασίες.

■ Προειδοποιητικές ενδείξεις στην κλιματιστική μονάδα

Προειδοποιητική ένδειξη	Περιγραφή		
 <table border="1"> <tr> <td>WARNING</td> </tr> <tr> <td>ELECTRICAL SHOCK HAZARD Disconnect all remote electric power supplies before servicing.</td> </tr> </table>	WARNING	ELECTRICAL SHOCK HAZARD Disconnect all remote electric power supplies before servicing.	<p>ΠΡΟΕΙΔΟΠΟΙΗΣΗ</p> <p>ΚΙΝΔΥΝΟΣ ΗΛΕΚΤΡΟΠΛΗΞΙΑΣ Αποσυνδέστε όλες τις απομακρυσμένες παροχές ηλεκτρικής τροφοδοσίας πριν από τη διενέργεια σέρβις.</p>
WARNING			
ELECTRICAL SHOCK HAZARD Disconnect all remote electric power supplies before servicing.			
 <table border="1"> <tr> <td>WARNING</td> </tr> <tr> <td>Moving parts. Do not operate unit with grille removed. Stop the unit before the servicing.</td> </tr> </table>	WARNING	Moving parts. Do not operate unit with grille removed. Stop the unit before the servicing.	<p>ΠΡΟΕΙΔΟΠΟΙΗΣΗ</p> <p>Κινούμενα μέρη. Μην θέσετε τη μονάδα σε λειτουργία, εάν έχετε αφαιρέσει τη γρίλια. Διακόψτε τη λειτουργία της μονάδας πριν από τη διενέργεια σέρβις.</p>
WARNING			
Moving parts. Do not operate unit with grille removed. Stop the unit before the servicing.			
 <table border="1"> <tr> <td>CAUTION</td> </tr> <tr> <td>High temperature parts. You might get burned when removing this panel.</td> </tr> </table>	CAUTION	High temperature parts. You might get burned when removing this panel.	<p>ΠΡΟΣΟΧΗ</p> <p>Μέρη με υψηλή θερμοκρασία. Ενδέχεται να υποστείτε έγκαυμα κατά την αφαίρεση αυτού του πίνακα.</p>
CAUTION			
High temperature parts. You might get burned when removing this panel.			
 <table border="1"> <tr> <td>CAUTION</td> </tr> <tr> <td>Do not touch the aluminum fins of the unit. Doing so may result in injury.</td> </tr> </table>	CAUTION	Do not touch the aluminum fins of the unit. Doing so may result in injury.	<p>ΠΡΟΣΟΧΗ</p> <p>Μην αγγίζετε τα πτερύγια αλουμινίου της μονάδας. Η μη συμμόρφωση ενδέχεται να προκαλέσει τραυματισμό.</p>
CAUTION			
Do not touch the aluminum fins of the unit. Doing so may result in injury.			
 <table border="1"> <tr> <td>CAUTION</td> </tr> <tr> <td>BURST HAZARD Open the service valves before the operation, otherwise there might be the burst.</td> </tr> </table>	CAUTION	BURST HAZARD Open the service valves before the operation, otherwise there might be the burst.	<p>ΠΡΟΣΟΧΗ</p> <p>ΚΙΝΔΥΝΟΣ ΕΚΡΗΞΗΣ Ανοίξτε τις βαλβίδες σέρβις πριν από τη λειτουργία, διαφορετικά ενδέχεται να προκληθεί έκρηξη.</p>
CAUTION			
BURST HAZARD Open the service valves before the operation, otherwise there might be the burst.			

1 Προφυλάξεις ασφαλείας

Ο κατασκευαστής δεν αναλαμβάνει ευθύνη για τυχόν βλάβες ή/θελε προκληθούν από αμέλεια συμμόρφωσης με τα όσα περιγράφονται στο παρόν εγχειρίδιο.

ΠΡΟΕΙΔΟΠΟΙΗΣΗ

Γενικά

- Διαβάστε προσεκτικά αυτό το Εγχειρίδιο χρήσης πριν από την εκκίνηση του κλιματιστικού. Πρέπει να έχετε υπόψη ένα πλήθος πραγμάτων για την καθημερινή λειτουργία.
- Ζητήστε η εγκατάσταση να διενεργηθεί από τον αντιπρόσωπο ή από επαγγελματία τεχνικό. Η εγκατάσταση του κλιματιστικού μπορεί να γίνει μόνον από εξειδικευμένο εγκαταστάτη(*1). Σε περίπτωση εγκατάστασης του κλιματιστικού από ανεπίδοτο άτομο, ενδέχεται να προκληθούν προβλήματα, όπως πυρκαγιά, ηλεκτροπληξία, τραυματισμός, διαρροή νερού, θόρυβος και κραδασμοί.
- Μην χρησιμοποιείτε ψυκτικό άλλο από το προβλεπόμενο, για συμπλήρωση ή αντικατάσταση. Διαφορετικά, ενδέχεται να αναπτυχθεί αντικανονικά υψηλή πίεση στον ψυκτικό κύκλο, κάτι που ενδέχεται να επιφέρει βλάβη του προϊόντος ή έκρηξη ή σωματικό τραυματισμό σας.
- Η εγκατάσταση δεν πρέπει να γίνεται σε περιοχές όπου ο ήχος λειτουργίας της εξωτερικής μονάδας μπορεί να προκαλέσει ενόχληση. (Ειδικά στη διαχωριστική γραμμή με τους γείτονες τοποθετήστε το κλιματιστικό λαμβάνοντας υπόψη τον θόρυβο.)

Μεταφορά και αποθήκευση

- Για τη μεταφορά του κλιματιστικού μηχανήματος, να φοράτε υποδήματα με μεταλλικά καλύμματα στις μύτες, προστατευτικά γάντια, και τη συναφή προστατευτική ενδυμασία.
- Για να μεταφέρετε το κλιματιστικό, μην το κρατάτε από τα τσέρκια που υπάρχουν γύρω από το χαρτοκιβώτιο της συσκευασίας του. Ενδέχεται να τραυματιστείτε, εάν οι ταινίες σπάσουν.
- Προτού τοποθετήσετε τα χαρτοκιβώτια σε κατακόρυφες στήλες για την αποθήκευση ή τη μεταφορά τους, λάβετε υπόψη τις προφυλάξεις που αναγράφονται στα χαρτοκιβώτια. Αν δεν τηρήσετε τις προφυλάξεις, μπορεί να προκληθεί κατάρρευση της στοιβας.
- Το κλιματιστικό μηχανήμα θα πρέπει να μεταφέρεται σε συνθήκες ευσταθείας. Εάν οποιοδήποτε κομμάτι του προϊόντος είναι σπασμένο, επικοινωνήστε με τον αντιπρόσωπο σας.
- Όταν είναι απαραίτητο το κλιματιστικό να μεταφερθεί με τα χέρια, θα πρέπει να το μεταφέρουν δύο ή περισσότερα άτομα.

Εγκατάσταση

- Η εκτέλεση των ηλεκτρολογικών εργασιών στο κλιματιστικό επιτρέπεται μόνον από εξειδικευμένο εγκαταστάτη(*1) ή εξειδικευμένο τεχνικό σέρβις(*1). Σε καμία περίπτωση δεν επιτρέπεται η εκτέλεση των εν λόγω εργασιών από ανεπίδοτο άτομο, επειδή τυχόν μη κατάλληλη εκτέλεση των εργασιών ενδέχεται να καταλήξει σε ηλεκτροπληξία ή/και διαρροές ρεύματος.
- Αφού ολοκληρωθούν οι εργασίες εγκατάστασης, ζητήστε από τον εγκαταστάτη να σας εξηγήσει τις θέσεις του διακόπτη κυκλώματος. Σε περίπτωση που παρουσιαστεί πρόβλημα στο κλιματιστικό, θέστε το διακόπτη κυκλώματος στη θέση OFF και επικοινωνήστε με έναν τεχνικό επισκευών.
- Εάν η μονάδα είναι εγκατεστημένη σε μικρό δωμάτιο, λάβετε τα κατάλληλα μέτρα έτσι ώστε το ψυκτικό να μην υπερβεί την οριακή συγκέντρωση, ακόμα και αν παρουσιάσει διαρροή. Κατά την εφαρμογή των μέτρων, συμβουλευτείτε τον αντιπρόσωπο από τον οποίο αγοράσατε το κλιματιστικό. Η συσσώρευση υψηλής συγκέντρωσης ψυκτικού υγρού ενδέχεται να προκαλέσει ατύχημα λόγω έλλειψης οξυγόνου.
- Μην εγκαταστήσετε το κλιματιστικό σε θέση, όπου υπάρχει κίνδυνος έκθεσης σε εύφλεκτο αέριο. Αν ένα εύφλεκτο αέριο διαρρεύσει και παραμείνει στο χώρο γύρω από τη μονάδα, ενδέχεται να προκληθεί πυρκαγιά.
- Χρησιμοποιήστε τα προϊόντα που προβλέπει η εταιρεία, όσον αφορά όσα εξαρτήματα αγοράσατε χωριστά. Η χρήση εξαρτημάτων που δεν προβλέπονται από την εταιρεία μπορεί να προκαλέσει πυρκαγιά, ηλεκτροπληξία, διαρροή νερού ή άλλο πρόβλημα. Η εγκατάσταση πρέπει να διενεργείται από επαγγελματία τεχνικό.
- Επαληθεύστε ότι η γείωση έχει γίνει σωστά.

Λειτουργία

- Πριν ανοίξετε τη γρίλια εισαγωγής της εσωτερικής μονάδας ή του πίνακα σέρβις της εξωτερικής μονάδας, θέστε τον αυτόματο διακόπτη κυκλώματος στη θέση OFF. Εάν δεν θέσετε τον αυτόματο διακόπτη κυκλώματος στη θέση OFF ενδέχεται να προκληθεί ηλεκτροπληξία λόγω τυχαίας επαφής με τα εξαρτήματα στο εσωτερικό της μονάδας. Η αφαίρεση της γρίλιας εισαγωγής της εσωτερικής μονάδας ή του πίνακα σέρβις της εξωτερικής μονάδας και η εκτέλεση των απαιτούμενων εργασιών, επιτρέπεται μόνον από εξειδικευμένο εγκαταστάτη(*1) ή εξειδικευμένο τεχνικό σέρβις(*1).
- Μέσα στο κλιματιστικό υπάρχουν σημεία με υψηλή τάση και περιστρεφόμενα μέρη. Λόγω του κινδύνου ηλεκτροπληξίας ή παγίδευσης των δακτύλων σας ή άλλων αντικειμένων στα περιστρεφόμενα μέρη, μην αφαιρείτε το πλαίσιο συντήρησης της εξωτερικής μονάδας. Όταν πρέπει να γίνει εργασία όπου απαιτείται η αφαίρεση αυτών των μερών, επικοινωνήστε με έναν εξειδικευμένο εγκαταστάτη ή εξειδικευμένο τεχνικό επισκευών.
- Μην μετακινείτε ή επισκευάζετε οποιαδήποτε μονάδα μόνι σας. Η παρουσία υψηλής τάσης στο εσωτερικό της μονάδας, μπορεί να σας προκαλέσει ηλεκτροπληξία όταν αφαιρέσετε το κάλυμμα και την κεντρική μονάδα.
- Χρησιμοποιήστε μια βάση με ύψος 50 cm ή περισσότερο για να καθαρίσετε το φίλτρο της εσωτερικής μονάδας ή για να εκτελέσετε άλλες εργασίες που απαιτούν την εργασία σε ύψη. Λόγω του κινδύνου πτώσης από τη βάση και τραυματισμού σας κατά την εργασία σε ύψη, αυτού του είδους οι εργασίες δεν πρέπει να εκτελούνται από μη εξειδικευμένα άτομα. Όταν πρέπει να εκτελεστούν τέτοιου είδους εργασίες, μην τις εκτελέσετε εσείς αλλά ζητήστε από έναν εξειδικευμένο εγκαταστάτη ή εξειδικευμένο τεχνικό επισκευών να τις κάνει για εσάς.
- Μην αγγίζετε το πτερύγιο αλουμινίου της εξωτερικής μονάδας. Ενδέχεται να τραυματιστείτε εάν το πιάξετε. Αν πρέπει να ακουμπήσετε το πτερύγιο, μην το ακουμπήσετε εσείς αλλά επικοινωνήστε με έναν εξειδικευμένο εγκαταστάτη ή εξειδικευμένο τεχνικό επισκευών.
- Μην ανεβαίνετε πάνω στην εξωτερική μονάδα και μην τοποθετείτε αντικείμενα πάνω σε αυτήν. Ενδέχεται να πέσετε εσείς ή τα αντικείμενα και να προκληθεί τραυματισμός.
- Μην τοποθετείτε συσκευή καύσης σε σημείο το οποίο εκτίθεται απευθείας στη ροή αέρα του κλιματιστικού, ενδέχεται να προκληθεί ατελής καύση.
- Όταν στον ίδιο χώρο με το κλιματιστικό λειτουργεί και συσκευή καύσης, φροντίστε το δωμάτιο να αερίζεται καλά. Ο ανεπαρκής εξαερισμός προκαλεί έλλειψη οξυγόνου.
- Όταν το κλιματιστικό χρησιμοποιείται σε κλειστό δωμάτιο, φροντίστε το δωμάτιο να αερίζεται καλά. Ο ανεπαρκής εξαερισμός προκαλεί έλλειψη οξυγόνου.
- Μην εκθέτετε το σώμα σας απευθείας στον ψυχρό αέρα για υπερβολικό χρονικό διάστημα και μην ψύχεστε υπερβολικά. Αυτό μπορεί να προκαλέσει αδιαθεσία και προβλήματα υγείας.
- Μη βάζετε ποτέ τα δάχτυλά σας ή κάποιο αντικείμενο στο στόμιο εισαγωγής ή εκροής αέρα. Αυτό μπορεί να προκαλέσει τραυματισμό, διότι ο ανεμιστήρας περιστρέφεται με υψηλή ταχύτητα στο εσωτερικό της μονάδας.
- Αν ο κλιματισμός (ψύξη και θέρμανση) δεν γίνεται σωστά, συμβουλευτείτε το κατάστημα από όπου αγοράσατε το κλιματιστικό, διότι η αιτία ενδέχεται να είναι η διαρροή ψυκτικού μέσου. Να επιβεβαιώνετε τις λεπτομέρειες επισκευής με εξειδικευμένο τεχνικό σέρβις(*1), όταν η επισκευή περιλαμβάνει πρόσθετη πλήρωση ψυκτικού μέσου.
- Πριν από τον καθαρισμό ας σβήνετε το κλιματιστικό και να κλείνετε τον αυτόματο διακόπτη κυκλώματος του. Διαφορετικά, μπορεί να προκληθεί τραυματισμός, διότι ο ανεμιστήρας περιστρέφεται με υψηλή ταχύτητα στο εσωτερικό της μονάδας.

Επισκευές

- Εάν παρουσιαστεί κάποιο πρόβλημα στο κλιματιστικό (όπως όταν εμφανιστεί μία ένδειξη σφάλματος, υπάρχει οσμή καμένου, ακούγονται ασυνήθιστοι θόρυβοι, το κλιματιστικό δεν ψύχει ή δε θερμαίνει ή υπάρχει διαρροή νερού), μην αγγίζετε το ίδιο το κλιματιστικό αλλά κλείστε τον αυτόματο διακόπτη κυκλώματος (στο OFF) και επικοινωνήστε με εξειδικευμένο τεχνικό σέρβις. Λάβετε μέτρα, ώστε να μην είναι επικίνδυνη η ενεργοποίηση της παροχής τροφοδοσίας (αναρτώντας πινακίδα με την ένδειξη "εκτός λειτουργίας" κοντά στον αυτόματο διακόπτη κυκλώματος, για παράδειγμα), έως ότου φθάσει ο εξειδικευμένος τεχνικός σέρβις. Εάν συνεχίζετε να χρησιμοποιείτε το κλιματιστικό παρόλο που παρουσιάζει πρόβλημα, ενδέχεται τα μηχανικά προβλήματά του να επιδεινωθούν ή να προκληθεί ηλεκτροπληξία κλπ.
- Εάν υπάρχει βλάβη στη σχάρα του ανεμιστήρα, μην πλησιάζετε στην εξωτερική μονάδα. Βάλτε τον αυτόματο διακόπτη κυκλώματος στο OFF και επικοινωνήστε με εξειδικευμένο τεχνικό σέρβις για την επισκευή του μηχανήματος. Μην θέσετε τον αυτόματο διακόπτη κυκλώματος στη θέση ON, εάν δεν ολοκληρωθούν οι επισκευές.
- Εάν υπάρχει κίνδυνος να πέσει η εσωτερική μονάδα, μην πλησιάζετε στην εσωτερική μονάδα, βάλτε τον αυτόματο διακόπτη κυκλώματος στο OFF και επικοινωνήστε με εξειδικευμένο εγκαταστάτη ή με εξειδικευμένο τεχνικό σέρβις για την επανατοποθέτηση της μονάδας. Μη θέσετε το διακόπτη κυκλώματος στη θέση ON πριν στερεωθεί πάλι η μονάδα.
- Εάν υπάρχει κίνδυνος να ανατραπεί η εξωτερική μονάδα, μην πλησιάζετε στην εξωτερική μονάδα, βάλτε τον αυτόματο διακόπτη κυκλώματος στο OFF και επικοινωνήστε με εξειδικευμένο εγκαταστάτη ή με εξειδικευμένο τεχνικό σέρβις για τη βελτίωση της στήριξης ή την επανατοποθέτηση της μονάδας. Μη θέσετε το διακόπτη κυκλώματος στη θέση ON πριν ολοκληρωθούν οι εργασίες βελτίωσης ή στερέωσης.
- Μην προσαρμόζετε τη μονάδα. Αν επέμβετε εσείς υπάρχει κίνδυνος πυρκαγιάς, ηλεκτροπληξίας ή άλλου προβλήματος.

Αλλαγή θέσης

- Όταν πρόκειται να αλλάξετε τη θέση του κλιματιστικού, μην αλλάξετε εσείς τη θέση του, αλλά επικοινωνήστε με έναν εξειδικευμένο εγκαταστάτη ή εξειδικευμένο τεχνικό επισκευών. Σε περίπτωση που η αλλαγή θέσης του κλιματιστικού δεν πραγματοποιηθεί σωστά, μπορεί να προκληθεί ηλεκτροπληξία ή/και πυρκαγιά.

⚠ ΠΡΟΣΟΧΗ

Για να αποσυνδέσετε τη συσκευή από το ρεύμα δικτύου.

- Αυτή η συσκευή πρέπει να συνδέεται με την κεντρική παροχή μέσω ενός διακόπτη με διαχωρισμό των επαφών τουλάχιστον κατά 3 mm.

Απαιτείται ασφάλεια για την εγκατάσταση (μπορεί να χρησιμοποιηθεί ασφάλεια οποιουδήποτε τύπου) για τη γραμμή τροφοδοσίας ρεύματος αυτού του κλιματιστικού μηχανήματος.

Εγκατάσταση

- Φροντίστε να τοποθετήσετε τον εύκαμπτο σωλήνα αποστράγγισης, για ιδανική αποστράγγιση. Η ανεπαρκής αποχέτευση μπορεί να προκαλέσει πλημμυρισμό της οικίας και το μούσκεμα των επιπέδων της.
- Συνδέστε το κλιματιστικό σε αποκλειστική τροφοδοσία ρεύματος με την ονομαστική τάση, διαφορετικά η μονάδα μπορεί να πάθει βλάβη ή να προκαλέσει πυρκαγιά.
- Βεβαιωθείτε ότι η εξωτερική μονάδα είναι στερεωμένη στη βάση. Διαφορετικά, μπορεί να προκληθεί πτώση των μονάδων ή άλλα ατυχήματα.









Λειτουργία

- Μην χρησιμοποιείτε αυτό το κλιματιστικό για άλλες χρήσεις όπως για τη συντήρηση τροφίμων ή οργάνων ακριβείας, έργων τέχνης, για την εκτροφή ζώων ή σε οχήματα, σκάφη κλπ.
- Μην αγγίζετε ποτέ τους διακόπτες με βρεγμένα δάκτυλα, διότι υπάρχει κίνδυνος ηλεκτροπληξίας.
- Στην περίπτωση που το κλιματιστικό θα παραμείνει εκτός λειτουργίας για σχετικά μεγάλο χρονικό διάστημα, κλείστε τον κεντρικό διακόπτη ή το διακόπτη κυκλώματος για λόγους ασφαλείας.
- Για να κάνετε το κλιματιστικό να λειτουργήσει στην αρχική του απόδοση, θέστε το σε λειτουργία εντός της κλίμακας των θερμοκρασιών λειτουργίας που προβλέπονται από τις οδηγίες. Ειδικά, μπορεί να προκληθεί δυσλειτουργία ή διαρροή νερού από τη μονάδα.
- Αποφύγετε την πτώση υγρών πάνω στο τηλεχειριστήριο. Μην ρίχνετε χυμούς, νερό ή οποιοδήποτε άλλο είδος υγρού.
- Μην πλένετε το κλιματιστικό. Αν το κάνετε, μπορεί να προκληθεί ηλεκτροπληξία.
- Ελέγξτε αν η βάση εγκατάστασης και ο άλλος εξοπλισμός έχουν υποστεί φθορά μετά από μακροχρόνια χρήση. Τέτοιου είδους χρήσεις μπορεί να προκαλέσει την πτώση της μονάδας και την πρόκληση τραυματισμού.
- Μην αφήνετε εύφλεκτα σπρέι ή άλλα εύφλεκτα υλικά κοντά στο κλιματιστικό και μην ψεκάζετε εύφλεκτο αερόλυμα απευθείας στο κλιματιστικό. Μπορεί να πιάσουν φωτιά.
- Πριν από τον καθαρισμό να σβήνετε το κλιματιστικό και να κλείνετε τον αυτόματο διακόπτη κυκλώματός του. Διαφορετικά, μπορεί να προκληθεί τραυματισμός, διότι ο ανεμιστήρας περιστρέφεται με υψηλή ταχύτητα στο εσωτερικό της μονάδας.
- Ζητήστε ο καθαρισμός του κλιματιστικού να διενεργηθεί από τον αντιπρόσωπο. Ο πλημμελής καθαρισμός του κλιματιστικού μηχανήματος μπορεί να επιφέρει βλάβη στα πλαστικά μέρη του, ζημιά της μόνωσης των ηλεκτρολογικών ή άλλων εξαρτημάτων και τη δυσλειτουργία της μονάδας. Στη δυσμενέστερη περίπτωση, ενδέχεται να προκαλέσει διαρροή νερού, ηλεκτροπληξία, αναθυμιάσει ή πυρκαγιά.
- Μην τοποθετείτε δοχείο με νερό, όπως π.χ. ένα βάζο, πάνω στη μονάδα. Μπορεί να προκύψει εισβολή νερού μέσα στη μονάδα και ενδέχεται να υπάρξει φθορά της ηλεκτρικής μόνωσης, με αποτέλεσμα να προκληθεί ηλεκτροπληξία.
- Μην πλένετε τα κλιματιστικά με πλυστικά μηχανήματα υψηλής πίεσης. Η διαρροή ηλεκτρικού ρεύματος μπορεί να προκαλέσει ηλεκτροπληξία ή πυρκαγιά.

(*1) Ανατρέξτε στην ενότητα "Ορισμός Εξειδικευμένου Εγκαταστάτη ή Εξειδικευμένου Τεχνικού Σέρβις".

■ Πληροφορίες σχετικά με τη μεταφορά, το χειρισμό και την αποθήκευση της κούτας

Παραδείγματα ενδείξεων στην κούτα

Σύμβολο	Περιγραφή	Σύμβολο	Περιγραφή
	Διατηρείτε στεγνό		Μην την αφήσετε να πέσει
	Εύθραυστο		Μην την ξαπλώσετε
	11 cartons		Μην περπατάτε πάνω στην κούτα
	Αυτή η πλευρά προς τα επάνω		Μην πατήσετε
	Προσεκτικός χειρισμός		

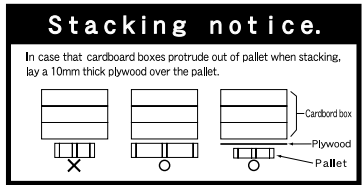
Άλλες προφυλάξεις	Περιγραφή
	ΠΡΟΣΟΧΗ Πιθανότητα τραυματισμού. Μην τη χειριστείτε με τον ιμάντα συσκευασίας, καθώς μπορεί να τραυματιστείτε σε περίπτωση που σπάσει ο ιμάντας.
	Σημείωση στοιβαξης. Σε περίπτωση που προεξέχουν χαρτόκουτες από μια παλέτα κατά τη στοιβαξη, Τοποθετήστε ένα κοντραπλακέ πάχους 10 mm πάνω στην παλέτα.

Благодарим вас за то, что приобрели кондиционер Toshiba.
Внимательно прочтите данные инструкции, так как в них содержится важная информация, соответствующая директиве "Оборудование" (Директива 2006/42/ЕС), и убедитесь, что они вам понятны.
Прочтя данные инструкции, сложите их в надежное место вместе с руководством по эксплуатации и руководством по установке, прилагаемыми к изделию.

Общее Обозначение: Кондиционер Воздуха





Определение квалифицированного монтажника или квалифицированного специалиста по обслуживанию

Этот кондиционер должен устанавливаться, обслуживаться, ремонтироваться и демонтироваться квалифицированным монтажником или квалифицированным специалистом по обслуживанию. Каждый раз, когда вам нужно будет проделать какую-либо из этих операций, обращайтесь к квалифицированному монтажнику или специалисту по обслуживанию.

Квалифицированный монтажник или квалифицированный специалист по обслуживанию — это лицо, имеющее квалификацию и знания, указанные в таблице ниже.

Лицо	Необходимые квалификация и знание
Квалифицированный монтажник	<ul style="list-style-type: none"> Квалифицированный монтажник — это лицо, которое устанавливает, обслуживает, перемещает и демонтирует кондиционеры производства компании Toshiba Carrier Corporation. Он или она прошел обучение по вопросам установки, технического обслуживания, переустановки и демонтажа кондиционеров производства компании Toshiba Carrier Corporation, или же он был научен таким действиям лицом или лицами, получившими необходимое обучение, и поэтому детально знаком со всем, что относится к указанным действиям. Квалифицированный монтажник, допущенный к выполнению необходимых электротехнических работ при установке, переустановке и демонтаже, имеет соответствующую этим работам квалификацию, предусмотренную местным законодательством и нормативами, и представляет собой лицо, обученное вопросам электротехнического характера, связанным с кондиционерами производства компании Toshiba Carrier Corporation, или же он был научен таким вопросам лицом или лицами, прошедшими необходимую подготовку, и поэтому детально знаком со всем, что относится к такой работе. Квалифицированный монтажник, допущенный к выполнению необходимых работ по прокладке трубок хладагента и обращению с хладагентом при установке, переустановке и демонтаже, имеет соответствующую этим работам квалификацию, предусмотренную местным законодательством и нормативами, и представляет собой лицо, обученное вопросам прокладки трубок хладагента и обращению с хладагентом, связанным с кондиционерами производства компании Toshiba Carrier Corporation, или же он был научен таким вопросам лицом или лицами, прошедшими необходимую подготовку, и поэтому детально знаком со всем, что относится к такой работе. Квалифицированный монтажник, допущенный к выполнению высотных работ, был обучен по вопросам, связанным с работой на высоте с кондиционерами производства Toshiba Carrier Corporation, или же получил указания по данному вопросу от лица или лиц, которые были этому обучены, и поэтому детально знаком со всем, что относится к такой работе.
Квалифицированный специалист по обслуживанию	<ul style="list-style-type: none"> Квалифицированный специалист по обслуживанию — это лицо, которое устанавливает, ремонтирует, обслуживает, перемещает и демонтирует кондиционеры производства компании Toshiba Carrier Corporation. Он или она прошел обучение по вопросам установки, ремонта, технического обслуживания, переустановки и демонтажа кондиционеров производства компании Toshiba Carrier Corporation, или же был обучен таким действиям лицом или лицами, получившими необходимое обучение, и поэтому детально знаком со всем, что относится к указанным действиям. Квалифицированный специалист по обслуживанию, допущенный к выполнению необходимых электротехнических работ при установке, ремонте, переустановке и демонтаже, имеет соответствующую этим работам квалификацию, предусмотренную местным законодательством и нормативами, и представляет собой лицо, обученное вопросам электротехнического характера, связанным с кондиционерами производства компании Toshiba Carrier Corporation, или же он был обучен таким вопросам лицом или лицами, прошедшими необходимую подготовку, и поэтому детально знаком со всем, что относится к такой работе. Квалифицированный специалист по обслуживанию, допущенный к выполнению необходимых работ по прокладке трубок хладагента и обращению с хладагентом при установке, ремонте, переустановке и демонтаже, имеет соответствующую этим работам квалификацию, предусмотренную местным законодательством и нормативами, и представляет собой лицо, обученное вопросам прокладки трубок хладагента и обращению с хладагентом, связанным с кондиционерами производства компании Toshiba Carrier Corporation, или же он был обучен таким вопросам лицом или лицами, прошедшими необходимую подготовку, и поэтому детально знаком со всем, что относится к такой работе. Квалифицированный специалист по обслуживанию, допущенный к выполнению высотных работ, был обучен по вопросам, связанным с работой на высоте с кондиционерами производства Toshiba Carrier Corporation, или же получил указания по данному вопросу от лица или лиц, которые были этому обучены, и поэтому детально знаком со всем, что относится к такой работе.

Предостерегающие указания на кондиционере

Предупреждающий символ	Описание		
 <table border="1"> <tr> <td>WARNING</td> </tr> <tr> <td>ELECTRICAL SHOCK HAZARD Disconnect all remote electric power supplies before servicing.</td> </tr> </table>	WARNING	ELECTRICAL SHOCK HAZARD Disconnect all remote electric power supplies before servicing.	<p>ПРЕДУПРЕЖДЕНИЯ</p> <p>ОПАСНОСТЬ ПОРАЖЕНИЯ ЭЛЕКТРИЧЕСКИМ ТОКОМ Перед выполнением обслуживания нужно отключить все внешние источники электроэнергии.</p>
WARNING			
ELECTRICAL SHOCK HAZARD Disconnect all remote electric power supplies before servicing.			
 <table border="1"> <tr> <td>WARNING</td> </tr> <tr> <td>Moving parts. Do not operate unit with grille removed. Stop the unit before the servicing.</td> </tr> </table>	WARNING	Moving parts. Do not operate unit with grille removed. Stop the unit before the servicing.	<p>ПРЕДУПРЕЖДЕНИЯ</p> <p>Движущиеся части. Запрещается работать на устройстве при движущейся решетке. Перед обслуживанием устройство нужно остановить.</p>
WARNING			
Moving parts. Do not operate unit with grille removed. Stop the unit before the servicing.			
 <table border="1"> <tr> <td>CAUTION</td> </tr> <tr> <td>High temperature parts. You might get burned when removing this panel.</td> </tr> </table>	CAUTION	High temperature parts. You might get burned when removing this panel.	<p>ПРЕДОСТЕРЕЖЕНИЕ</p> <p>Горячие детали. При снятии этой панели можно получить ожог.</p>
CAUTION			
High temperature parts. You might get burned when removing this panel.			
 <table border="1"> <tr> <td>CAUTION</td> </tr> <tr> <td>Do not touch the aluminum fins of the unit. Doing so may result in injury.</td> </tr> </table>	CAUTION	Do not touch the aluminum fins of the unit. Doing so may result in injury.	<p>ПРЕДОСТЕРЕЖЕНИЕ</p> <p>Не касайтесь алюминиевого оребрения на устройстве. Это может привести к травме.</p>
CAUTION			
Do not touch the aluminum fins of the unit. Doing so may result in injury.			
 <table border="1"> <tr> <td>CAUTION</td> </tr> <tr> <td>BURST HAZARD Open the service valves before the operation, otherwise there might be the burst.</td> </tr> </table>	CAUTION	BURST HAZARD Open the service valves before the operation, otherwise there might be the burst.	<p>ПРЕДОСТЕРЕЖЕНИЕ</p> <p>ОПАСНОСТЬ РАЗРЫВА Отсоедините все дистанционные устройства перед обслуживанием нужно открыть вентили, иначе может произойти разрыв.</p>
CAUTION			
BURST HAZARD Open the service valves before the operation, otherwise there might be the burst.			

1 Правила техники безопасности

Производитель не несет ответственности за ущерб, вызванный несоблюдением инструкций, приведенных в данном руководстве.

ПРЕДУПРЕЖДЕНИЯ

Общие

- Внимательно прочтите данное Руководство пользователя перед запуском кондиционера. При каждом использовании кондиционера следует учитывать множество важных аспектов.
- Для выполнения установки системы обратитесь к дилеру или специалисту. Установку кондиционера воздуха способен только квалифицированным монтажникам по установке (*1). Установка кондиционера неквалифицированным лицом может привести к возникновению таких проблем, как: пожар, поражение электрическим током, травмы, утечка воды, шум и вибрация.
- Запрещается использовать для пополнения или замены хладагент, отличный от указанного. В противном случае в контуре охлаждения может образоваться аномально высокое давление, что может привести к поломке или взрыву изделия, а также вызвать травмы.
- Места, где шум работы наружного блока может причинить беспокойство. (При установке наружного блока на границе с соседями учитывайте уровень шума.)

Перевозка и хранение

- Для перемещения кондиционера необходимо надевать ботинки с защитным носком, защитные перчатки и другую защитную одежду.
- При транспортировке кондиционера не беритесь за обвязку вокруг картонной упаковки. Если обвязка лопнет, вы можете получить травму.
- Прежде чем складировать упаковочные коробки для хранения или перевозки, прочитайте и выполните указанные на них меры предосторожности. В противном случае штабель может рухнуть.
- При перевозке кондиционер должен находиться в устойчивом положении. Если какая-либо часть изделия повреждена, обратитесь к вашему дилеру.
- Переноску кондиционера должны осуществлять не менее двух человек.

Установка

- Проводить электротехнические работы по установке кондиционера разрешается только квалифицированному монтажнику(*1) или квалифицированному специалисту по обслуживанию(*1). Ни при каких обстоятельствах эти работы нельзя поручать неквалифицированным лицам, иначе при неправильном выполнении работ возможны поражения электрическим током и/или утечка электроэнергии.
- По окончании установки монтажник должен рассказать, где расположены сетевые выключатели. В случае проблем с кондиционером установите сетевой выключатель в положение OFF (Выкл) и свяжитесь со специалистом по обслуживанию.
- При установке в небольшом помещении нужно принять меры к тому, чтобы даже в случае утечки хладагента не создавалась его предельно допустимая концентрация в воздухе помещения. При применении указанных мер нужно консультироваться с дилером, у которого был приобретен данный кондиционер. Накопление паров хладагента в высоких концентрациях может вызвать несчастный случай из-за кислородной недостаточности.
- Не устанавливайте кондиционер в местах, подверженных риску воздействия воспламеняющихся газов. В случае утечки воспламеняющегося газа и повышения его концентрации вокруг блока может произойти возгорание.
- Что касается отдельно приобретаемых частей, используйте только изделия, указанные производителем. Использование изделий, отличных от указанных производителем, может привести к пожару, поражению электрическим током, утечке воды и другим проблемам. Для выполнения установки обращайтесь к специалисту.
- Убедитесь в том, что заземление правильно выполнено.

Эксплуатация

- Прежде чем снимать решетку на воздухозаборнике внутреннего блока или на служебной панели наружного блока, установленного вне помещения, установите сетевой выключатель в положение OFF (Выкл). Если сетевой выключатель не установить в положение OFF (Выкл), можно получить удар электрическим током при контакте с внутренними узлами кондиционера. Снимать решетку воздухозаборника на устройствах, установленных в помещении и вне его, разрешается только квалифицированным монтажникам(*1) или квалифицированным специалистам по обслуживанию(*1).
- Внутри кондиционера есть участки, находящиеся под высоким напряжением, и вращающиеся детали. Из-за опасности поражения электрическим током или травмы при попадании пальцев или других предметов во вращающиеся части, не снимайте служебную панель наружного блока. Для проведения работ, при которых нужно снимать эти детали, вызывайте квалифицированного монтажника или квалифицированного специалиста по обслуживанию.
- Не перемещайте и не выполняйте ремонт устройств самостоятельно. Внутри устройства находятся компоненты под высоким напряжением, и снятие крышки или основного устройства может привести к поражению электрическим током.
- Использование подставки высотой более 50 см для чистки фильтра внутреннего блока или выполнения других работ относится к категории высотных работ. Из-за опасности падения и сопутствующих этому травм эту работу не должны выполнять неквалифицированные лица. Когда возникает необходимость в такой работе, не делайте ее самостоятельно, а обратитесь к квалифицированному монтажнику или специалисту по обслуживанию.
- Не касайтесь алюминиевого оребрения на наружном блоке. В противном случае можно получить травму. Если нужно касаться оребрения, не делайте этого сами, квалифицированного монтажника или квалифицированного специалиста по обслуживанию.
- Запрещается залезать или класть какие-либо предметы на верхнюю часть наружного блока. Вы можете упасть, или же эти предметы могут свалиться с наружного блока и причинить травму.
- Нельзя устанавливать какие-либо отопительные приборы в местах, где на них будет непосредственно попадать воздушный поток от кондиционера, так как это может приводить к неполному сгоранию.
- Если кондиционер эксплуатируется в одном помещении с устройствами горения, необходимо обеспечить достаточную вентиляцию помещения. Плохая вентиляция вызывает недостаток кислорода.
- При использовании кондиционера в закрытом помещении необходимо обеспечить достаточную вентиляцию помещения. Плохая вентиляция вызывает недостаток кислорода.
- Не направляйте поток холодного воздуха на свое тело в течение длительного времени и не переохлаждайтесь. Это может привести к ухудшению физического состояния и болезням.
- Нельзя вставлять палец или какие-либо предметы в воздухозаборное и воздуховыпускное отверстия.
- В случае ненадлежащего выполнения кондиционирования воздуха (охлаждения и обогрева) обратитесь в магазин, в котором вы приобрели кондиционер, поскольку причина может заключаться в утечке холодильного агента. Когда ремонт включает в себя дополнительное пополнение хладагента, проверьте детали ремонта вместе с квалифицированным специалистом по обслуживанию(*1).
- Перед выполнением чистки отключите кондиционер и выключатель. Несоблюдение этого указания может привести к травмам, поскольку вентилятор внутри блока вращается на высокой скорости.

Ремонт

- Если возникли какие-либо неполадки в работе кондиционера (например, появилось сообщение об ошибке, запах гари, слышны странные звуки, кондиционер не охлаждает или не нагревает воздух, подтекает вода), не трогайте кондиционер самостоятельно, переведите его сетевой выключатель в положение выключения OFF (Выкл) и вызовите квалифицированного специалиста по обслуживанию. До прибытия квалифицированного специалиста по обслуживанию позаботьтесь о том, чтобы электропитание кондиционера не могло быть случайно включено (например, поставьте знак "Не работает" рядом с сетевым выключателем). Продолжение эксплуатации неисправного кондиционера может привести к усугублению механических проблем и стать причиной поражения электрическим током и поломок.
- Если повреждена решетка воздухозаборника, не подходите к наружному блоку, а вместо этого установите сетевой выключатель в положение OFF (Выкл) и вызовите квалифицированного специалиста по обслуживанию для ремонта. До окончания ремонта не возвращайте сетевой выключатель в положение ON (Вкл).
- Если возникла опасность падения внутреннего блока, не приближайтесь к нему, а установите сетевой выключатель в положение OFF (Выкл) и вызовите квалифицированного монтажника или специалиста по обслуживанию для укрепления блока. До окончания ремонта не возвращайте сетевой выключатель в положение ON (Вкл).
- Если возникла опасность опрокидывания наружного блока, не приближайтесь к нему, а установите сетевой выключатель в положение OFF (Выкл) и вызовите квалифицированного монтажника или специалиста по обслуживанию для укрепления блока или его повторного монтажа. До окончания работ по укреплению блока или его перемонтажу не возвращайте сетевой выключатель в положение ON (Вкл).
- Не модифицируйте устройство. Это может привести к пожару, поражению электрическим током и другим проблемам.

Переустановка на другое место

- Если нужно переустановить кондиционер на другое место, не делайте этого сами, квалифицированного монтажника или квалифицированного специалиста по обслуживанию. Неправильная переустановка кондиционера может привести к поражению электрическим током и/или к пожару.

⚠ ПРЕДОСТЕРЕЖЕНИЕ

Для отключения устройства от источника питания.

- Это устройство необходимо подключать к сети с помощью переключателя с зазором между разомкнутыми контактами не менее 3 мм.

В цепи подачи питания данного кондиционера при установке должен быть установлен предохранитель (могут использоваться предохранители любого типа).

Установка

- Обязательно проложите сливной шланг для обеспечения хорошего слива. Плохой сток может привести к затоплению помещения и намоканию мебели.
- Используйте для кондиционера отдельный источник питания с требуемым номинальным напряжением, иначе устройство может сломаться или стать причиной пожара.
- Убедитесь в том, что наружные блоки зафиксированы на платформе. В противном случае блоки могут упасть или могут произойти другие несчастные случаи.









Эксплуатация

- Не используйте этот кондиционер для специальных целей, например сохранения продуктов, точных приборов, объектов искусства, разведения животных, хранения автомобилей, летательных аппаратов.
- Не прикасайтесь к элементам управления влажными руками, так как это может привести к поражению электрическим током.
- Если кондиционер не будет использоваться в течение длительного времени, то для обеспечения безопасности отключайте главный выключатель или сетевой выключатель.
- Для поддержания максимальной производительности кондиционера его следует использовать при указанном в инструкции диапазоне рабочих температур. Несоблюдение этого требования может привести к повреждению устройства или возникновению протечек воды.
- Не допускайте попадания жидкости на пульт дистанционного управления. Не проливайте на него сок, воду и другие жидкости.
- Не мойте кондиционер водой. Это может привести к поражению электрическим током.
- После продолжительной эксплуатации проверяйте установочную платформу и другое оборудование на предмет износа. Если оставить их в подобном состоянии, блок может упасть и стать причиной травмы.
- Не оставляйте легковоспламеняющиеся аэрозоли и другие горючие материалы вблизи кондиционера и не распыляйте легковоспламеняющиеся аэрозоли непосредственно на кондиционер. Они могут воспламениться.
- Перед выполнением чистки отключайте кондиционер и выключатель. Несоблюдение этого указания может привести к травмам, поскольку вентилятор внутри блока вращается на высокой скорости.
- Для выполнения чистки кондиционера обратитесь к дилеру. Неправильное выполнение чистки кондиционера может стать причиной повреждения пластмассовых деталей, нарушения изоляции электрических и других частей, а также привести к неполадкам в работе. В худшем случае это может привести к утечке воды, поражению электрическим током, задымлению и пожару.
- Не ставьте на устройство емкости с водой, например вазы. Вода может проникнуть внутрь устройства, и это может вызвать порчу электрической изоляции и привести к поражению электрическим током.
- Не промывайте кондиционеры с помощью напорных промывателей. Утечки электричества могут привести к поражениям электрическим током или возгораниям.

(*1) См. "Определение квалифицированного монтажника или квалифицированного специалиста по обслуживанию".

■ Сведения по перевозке, переноске и хранению упаковки

Примеры обозначений на упаковке

Символ	Описание	Символ	Описание
	Хранить в сухом месте		Не бросать
	Хрупкое		Не класть набок
 11 cartons	Высота штабелирования (в данном случае можно составлять штабель из 12 упаковок)		Не ходить по упаковке
	Верх		На становиться
	Обращаться осторожно		

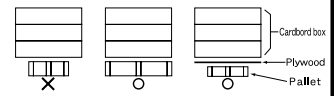
Другие меры предосторожности	Описание
 <div style="border: 1px solid black; padding: 5px; width: fit-content;"> <p>Caution Injury possibility. Don't handle with packing band, or may get injured in case of broken band.</p> </div>	<p>ПРЕДОСТЕРЕЖЕНИЕ</p> <p>Возможна травма. Не переносить, держа за упаковочную ленту, в противном случае при разрыве ленты возможна травма.</p>
<p>Stacking notice.</p> <p>In case that cardboard boxes protrude out of pallet when stacking, lay a 10mm thick plywood over the pallet.</p> 	<p>Примечание по штабелированию.</p> <p>Если картонные коробки выступают за пределы поддона при штабелировании. Положить на поддон лист фанеры толщиной 10 мм.</p>

2 Part names

Indoor unit

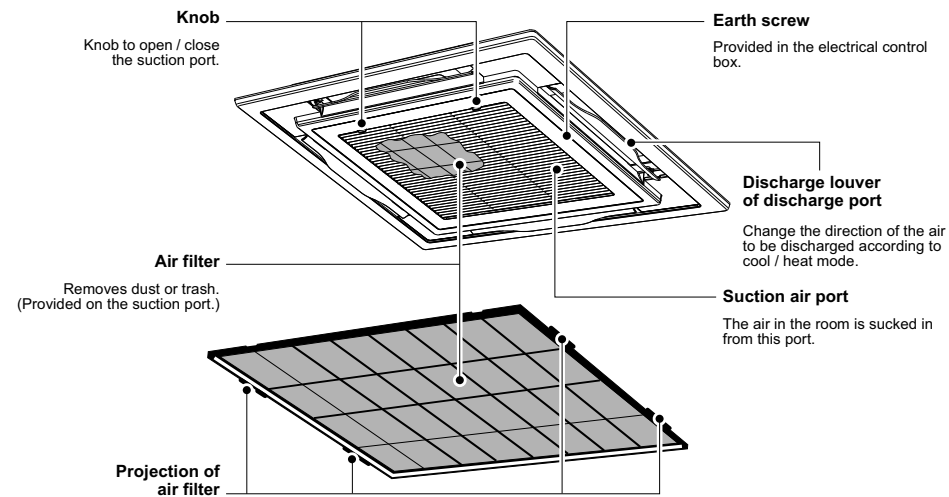

Outdoor unit (The design varies depending on the outdoor unit. The following illustration shows an example.)

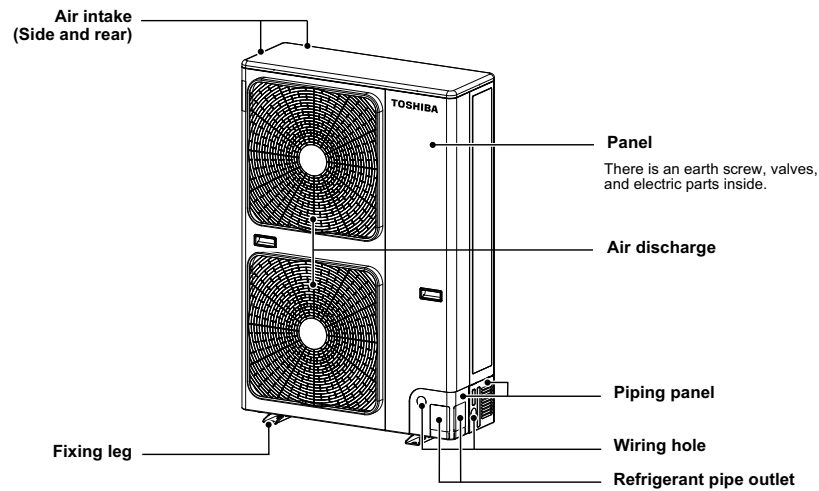

3 Wired remote controller

This remote controller can control the operation of up to 8 indoor units.

Display section

In the display illustration below all the icons are shown. When the unit is in operation, only relevant icons will be displayed.

- When the leak breaker is turned on for the first time, **SETTING** flashes on the display part of the remote controller.
- While this icon is flashing, the model is being automatically confirmed. Wait till **SETTING** icon has disappeared to use the remote controller.

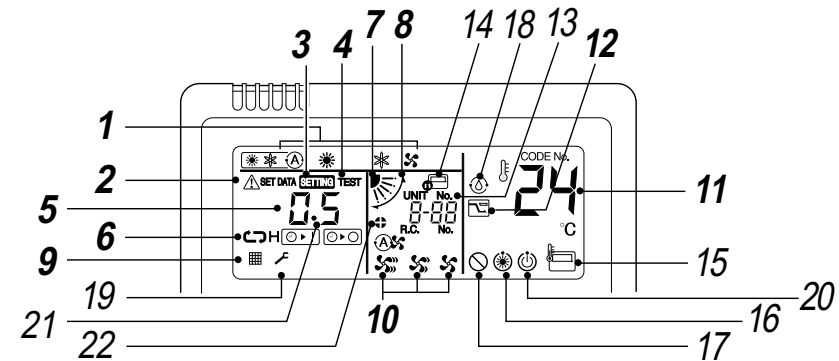
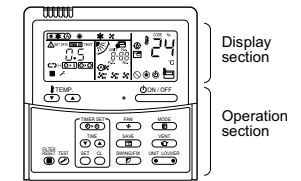

1 Operation mode

The selected operation mode is displayed.

2 Error display

Displayed while the protective device works or a error occurs.

3 SETTING display

Displayed during setup of the timer or other settings.

4 TEST run display

Displayed during a test run.

5 Timer display

When an error occurs, error code is displayed.

6 Timer mode display

The selected timer mode is displayed.

7 Louver position display

Displays louver position.

8 Swing display

Displayed during up / down movement of the louver.

9 Filter display

Reminder to clean the air filter.

10 Fan speed display

The selected fan speed mode is displayed.

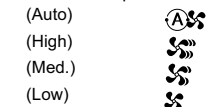

11 Set temperature display

The selected set temperature is displayed.

12 Power saving mode display

Limits compressor speed (capacity) to save energy.

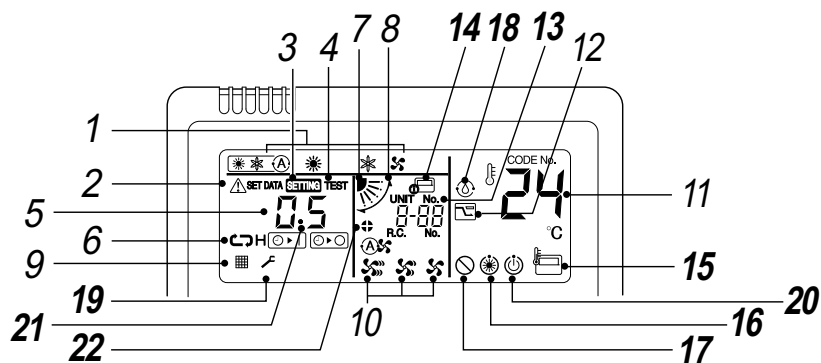

13 UNIT No. display

Displays the number of the indoor unit selected.
Also displays error code of indoor and outdoor units.

14 Central control display

Displayed when the air conditioner is used under the central control in combination with a central control remote controller.

In case the remote controller is disabled by the central control system, flashes.
The button operation is not accepted.

Even when ON / OFF, MODE, or TEMP. button is pushed, and the button operation is not accepted.
(Settings made by the remote controller vary with the central control mode. For details, refer to the Owner's Manual of the central control remote controller.)

15 Remote controller sensor display

Displayed while the sensor of the remote controller is used.

16 Pre-heat display

Displayed when the heating mode is energized or defrost cycle is initiated.
While this icon is displayed, the indoor fan stops.

17 No function display

Displayed when the function requested is not available on that model.

18 Self clean operation display

Displayed during self clean operation to dry the indoor heat exchanger.

19 Service display

20 Operation ready display

This display appears on some models.

21 Louver Number display. (example: 01, 02, 03, 04)

22 Louver lock display

Displayed when there is a louver-locked unit in the group (including 1 indoor unit by 1 outdoor unit).

■ Operation section

Push each button to select a desired operation.

- The control saves commands in memory and after the initial setting, there is no need for any additional settings unless changes are desired. The air conditioner can be operated by pushing the button.

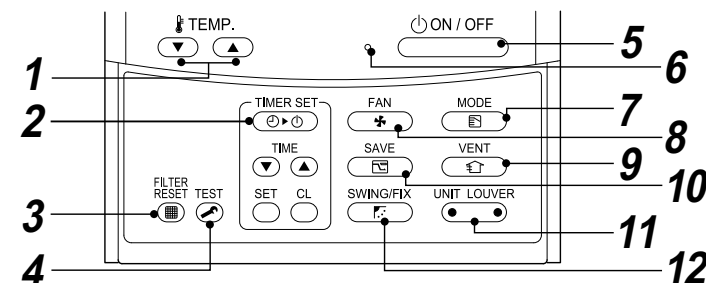

1 button (Temperature set button)

Adjusts the set point.
Select the desired set point by pushing or .

2 button (Timer set button)

Use to setup the timer.

3 button (Filter reset button)

Resets display after cleaning filter.

4 button (Test button)

Use only for service.
(During normal operation, do not use this button.)

5 button

When the button is pushed, the operation starts, and it stops by pushing the button again.
When the operation has stopped, the operation lamp and all the displays disappear.

6 Operation lamp

Green light illuminates when unit is on.
Although it flashes when operating the protection device or an error occurs.

7 button (Operation mode button)

Selects desired operation mode.

8 button (Fan speed button)

Selects the desired Fan speed.

9 button (Ventilation button)

Use when a power ventilation kit (locally procured) is connected.

- If is displayed on the remote controller when this button is pushed, no vent kit connected.

10 button (Power save operation)

Use to initiate power saving mode.

11 button (Unit / Louver select button)

Selects a unit number (left) and louver number (right).

UNIT:

Selects an indoor unit when adjusting wind direction multiple indoor units are controlled with one remote controller.

LOUVER:

Selects a louver when setting wind direction adjustment independently.

12 button (Swing / Louver direction button)

Selects automatic swing or setting the louver direction.

OPTION :

Remote controller sensor

Usually the temperature sensor of the indoor unit senses the temperature. The temperature on the surrounding of the remote controller can also be sensed.

For details, contact the dealer from which you have purchased the air conditioner.

4 Correct usage

When the air conditioner is used for the first time or when the setting is changed, follow the steps below. Settings are saved in memory and are displayed anytime the unit is turned on by pushing the  button.

■ Preparation



- When the circuit breaker is turned on, the partition lines are displayed on the remote controller.
- * **After the circuit breaker is turned on, the remote controller does not accept any commands for approx. 1 minute, this is not a failure.**

REQUIREMENT

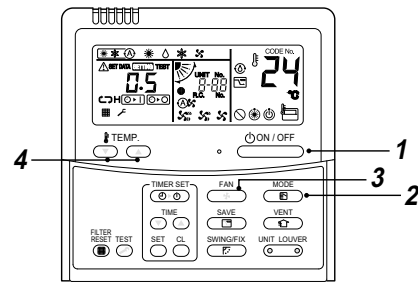
When the air conditioner is re-powered after it has not been used for a long period, turn on the circuit breaker at least 12 hours before starting the air conditioner.





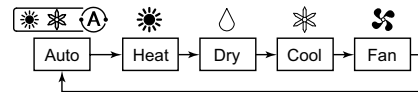

Start



- 1 Push  button.**
The operation lamp illuminates, and the operation starts.
- 2 Select an operation mode with the “” button.**
One push of the button, and the display changes in the order shown below.



- 3 Select fan speed with “” button.**
One push of the button, and the display changes in the order shown below.



- When fan is in “ Auto”, fan speed is adjusted based on difference between set point and room temperature.
- In heating operation, if the room temperature is not heated sufficiently with speed “ Low” operation, select “ Med.” or “ High” operation.
- The temperature sensor detects the return air temperature at the indoor unit, which differs from the room temperature depending on the installation condition.
Set point is a target of room temperature.
( “Auto” is not selectable in the Fan mode.)

- 4 Select the set point temperature by pushing the “TEMP. ” or “TEMP. ” buttons.**

Stop

Push  button.
The operation lamp goes off, and the operation stops. In the Cool, Dry, or Auto (cooling) mode, the fan runs for 10 minutes (or more) for self clean operation.

NOTE

Auto Changeover

- When in Auto Mode, the unit selects the operating mode (cooling, heating or fan only) based on the user set point temperature.
- If the Auto mode is uncomfortable, you can select the desired conditions manually.

Cooling

- If there is a demand for cooling, unit will start approximately 1 minute after mode is selected.

Heating

- If there is a demand for heating, unit will start approximately 3 to 5 minutes after the mode is selected.
- After the heating operation has stopped, fan may continue to run for approx. 30 seconds.
- When the room temperature reaches the set temperature, the outdoor unit stops and the indoor unit fan runs at extremely low speed.
During defrost operation, the fan stops so that cool air is not discharged. (“” Pre-heat is displayed.)

When restarting the operation after stop



When the unit is attempted to restart immediately after it was stopped, the unit can not start for approx. 3 minutes this is to protect the compressor.

■ 8 °C operation (For object pre-heating)

(SDI 4series and DI 4series (RAV-SP***4AT / RAV-SM***4AT) only)

The air conditioner can control the heating temperature to about 8 °C in the heating mode.
The 8 °C heating operation requires settings with the wired remote controller. Ask the installer or dealer for the settings according to the installation manual of the indoor unit.



Start

- 1 Set the displayed temperature to 18 °C in the heating mode by pushing TEMP.  button.**
- 2 Set the displayed temperature to 8 °C by pushing TEMP.  button for at least four seconds.**

Stop

- 1 Set the displayed temperature to 18 °C by pushing TEMP.  button.**
 - The air conditioner returns to the normal Heat mode. Select a desired temperature and operation mode.

NOTE

- The discharged air temperature is lower than that in the normal heating operation.
- The room temperature may not be heated evenly depending on the remote controller installation location.
- The room temperature may not reach 8 °C depending on the room size or the installation conditions.
- Setting for fan speed is available during the 8 °C heating operation.
The 8 °C heating operation is cancelled in the following cases.
 - When operation is stopped with  button
 - When another operation mode is selected with  button
 - When temperature setting or operation mode is changed or operation is started / stopped by the wireless remote controller or the central control remote controller.
- When this operation mode is used, observe proper operating hours and periodic maintenance by service staff is recommended.

5 Timer operation

- Three timer modes are available: (Setting of up to 168 hours is enabled.)
 - Off timer : The unit stops when the set time is reached.
 - Repeat Off timer : The unit stops daily when the set time is reached.
 - On timer : The unit starts when the set time is reached.

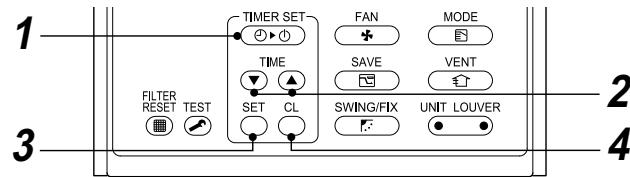

Set

1 Push **TIMER SET** button.

The timer mode changes with every push of the button.

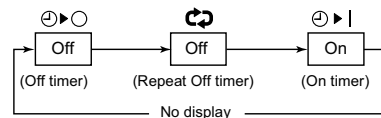

- SETTING** and timer display flashes.

2 Push **TIME** to select "set time".

- With every push of **TIME** button, the set time increases by 0.5 hr (30 minutes). When setting a time more than 24 hours for timer operation, timer can be set in increments of 1 hr. The maximum set time is 168 hr (7 days). The remote control displays the set time with time (between 0.5 and 23.5 hours) (*) or number of days and time (24 hours or more) (**) as shown below.
- With every push of **TIME** button, the set time decreases by 0.5 hr (30 minutes) (0.5 - 23.5 hours) or 1 hr (24 - 168 hours).

Example of remote control display

- 23.5 hours (*)



- 34 hours (**)



Number of days Time

1d shows 1 day (24 hours).

10h shows 10 hours. (Total 34 hours)

3 Push **SET** button.

- SETTING** icon disappears and time display goes on, and **▶|** or **▶|◊** icon flashes. (When On timer is activated, time and On timer **▶|** are icons and other icons disappear.)

4 Cancel timer operation

- Push **SWING/FIX** button. Timer icon disappears.

NOTE

- When the operation stops after the timer reached the preset time, the Repeat Off timer resumes the operation by pushing **ON/OFF** button and stops the operation after the time of the timer has reached the set time.
- When **SWING/FIX** is pushed while the Off timer function of the air conditioner is active, the indication of the timer function disappears and then appears again after about 5 seconds. This is due to normal processing of the remote controller.

6 Adjustment of wind direction

For best cooling and heating performance, adjust the louvers (adjustment plates of up / down wind direction) appropriately. Cold air descends and warm air rises, so to heat a room tilt the louvers downward, and to cool a room tilt them horizontally.

CAUTION

Direct the louvers horizontally for cooling. If the louvers stay pointed downward when cooling, condensation may form on the discharge port and / then drops from the louvers.

NOTE

If the louvers stay pointed straight out horizontally when heating, the room temperature may be unevenly distributed.

For cooling (COOL)

Direct the louvers horizontally.

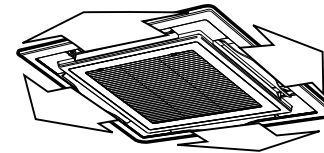

For heating (HEAT)

Direct the louvers downward.

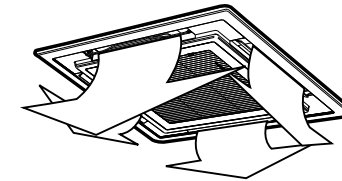

- When the air conditioner is not working, the louvers are directed horizontally automatically.
- The louvers are directed horizontally when heating begins, during defrost operation, or during the minimum operation after reaching the set temperature. When a swing or louver direction setting is made at this time, the remote controller display varies with the setting, but the louvers stay pointed straight out horizontally. When the air conditioner starts heating, the louvers are directed to the set direction.

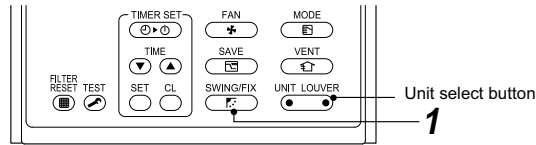

How to set up the louver direction

1 Push **SWING/FIX** during operation.
The louver direction changes for every push of the button.

In HEAT operation

Direct the louver (adjustment plate of up / down wind direction) downward. If directing at horizontally, hot air may not come to the foot.

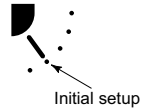

In COOL / DRY operation

Direct the louver (adjustment plate of up / down wind direction) horizontally. If directing it downward, the dew may form on the surface of the air discharge port and may drop down.

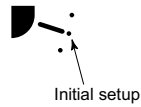

In FAN operation

Select a desired louver direction.

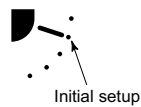

How to start swinging

1 Push **SWING/FIX**, set the louver (adjustment plate of up / down wind direction) direction to the lowest position, and then push **SWING/FIX** again. SWING is displayed and the up / down louver direction is automatically selected.

Display during swinging

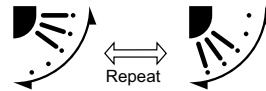

How to stop swinging

1 Push **SWING/FIX** at a desired position while the louver is swinging.
 • When **SWING/FIX** is pushed after that, wind direction can be set again from the highest position.
 * However, even if **SWING/FIX** is pushed while the louver is swinging, the louver position is displayed as follows and highest position of the louver may not be selected.

Display when swinging is stopped



In this case, push **SWING/FIX** again two seconds later.
 • In Cool / Dry operation, the louver does not stop as it directs downward during swing operation, it stops after moving to the third position from the highest position.

Display when stopping the swing



Unit select button

- When multiple indoor units are controlled with one remote controller, louver direction can be set for each indoor unit by selecting individually.
- To set louver direction individually, push **UNIT LOUVER** button to display an indoor unit number in the control group. Then set the wind direction of the displayed indoor unit.
- When no indoor unit number is displayed, all indoor units in the control group can be controlled simultaneously.
- Each time **UNIT LOUVER** button is pushed, the display changes as follows:

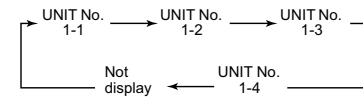

How to set louver wind direction individually

1 Select an indoor unit to be set by pushing **UNIT LOUVER** (left side of the button) during operation.
 • The indoor unit number changes each time you push the button.

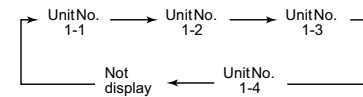

* When no unit number is displayed, all indoor units are selected.

2 Select a louver you want to adjust change by pushing **UNIT LOUVER** (right side of the button).
 • Each time you push the button, the display on the left of the remote controller changes as follows:

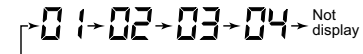

* When no louver number is displayed, all four louvers are selected.

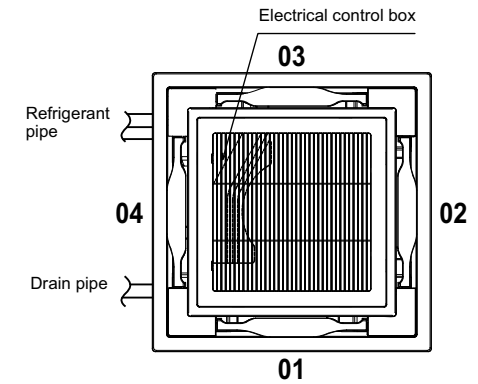
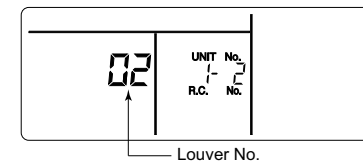

3 Determine wind direction of the selected louver by pushing **SWING/FIX**.

- Each time you push the button, the display changes as follows:

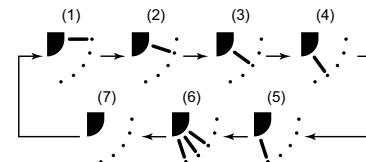

* During COOL (DRY) mode, (4) and (5) are not displayed.

7 Power saving mode

The power saving mode saves energy by limiting the maximum current which will effect cooling capacity that the unit can generate.

Push  button during operation.

- The air conditioner enters power saving mode.
-  appears on the display.

Power saving mode will stay in effect until it is cancelled.

To cancel the power saving mode, push  button again.

-  disappears.

■ To configure the power saving mode settings

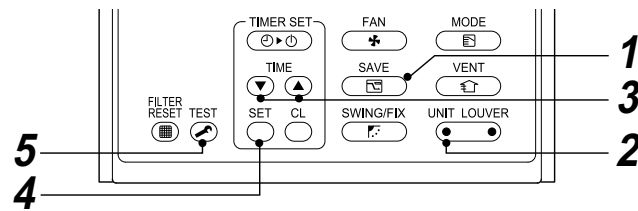



1 Push  button for at least four seconds when the air conditioner is not working.

- , symbol, and numbers flash.

2 Push  (left side of the button) to select an indoor unit to be set.

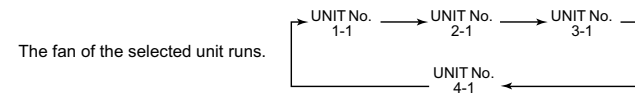
- Each time the button is pushed, UNIT No. change as follows:



3 Push TIME   buttons, to adjust the power saving mode setting.

- Each push of the button changes the power level by 1 % within the range from 100 % to 50 %.
- The factory default is 75 %.

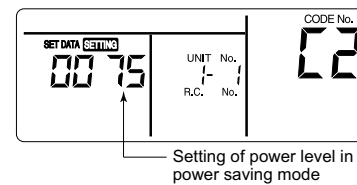

4 Push  button.

5 Push  button to complete the setting.

NOTE

- When other electric appliances are used at the same time, to avoid triggering the circuit breaker, power saving mode is recommended. Of course power saving mode can be used to save energy as well.
- Power saving mode consumes less energy, but may not cool the room as much as normal mode. (The maximum current is limited to approximately 75 % (factory default) of the normal mode.)
- Even when operation start / stop, operation mode change, or power reset is performed during the power saving mode, the power saving mode is retained until the next operation.

8 Self clean mode

This function is provided to dry the inside of the indoor unit by the FAN operation after running the cooling / dry / AUTO (cooling) mode to keep the indoor unit clean.

- The self clean time varies with the cooling / dry / Auto (cooling) operation time as follows.

Cooling / dry / Auto (cooling) operation time	self clean time
Less than 10 minutes	No self clean operation
10 minutes to less than 1 hour	1 hour
More than 1 hour	2 hours

- "△" is displayed on the remote controller during self clean operation.

To stop self clean forcibly, push  button twice in succession.

⚠ CAUTION

- The fan continues to run even after  button is pushed to stop operation in some modes. This is normal because the self clean mode is in progress.
- The louvers open slightly and are directed horizontally during self clean, and they close when the self clean is completed.
- The operation lamp (LED) does not light during the self clean mode (function).
- The self clean mode (function) cannot clean the room or remove the already existing mold and dust inside the indoor unit.
- To cancel the self clean function, consult the dealer.

9 Advanced settings

How to set up swing type

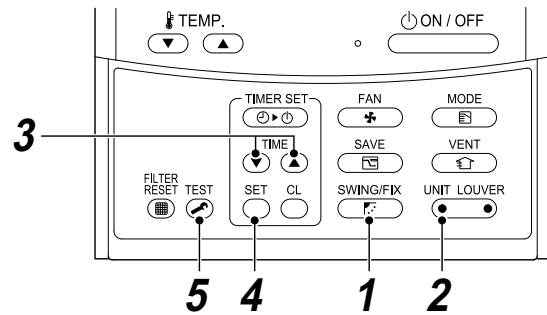

1 Push **SWING/FIX** for at least four seconds when the air conditioner is not working.

- **SETTING**, symbol, and numbers flash.

2 Select an indoor unit to be set by pushing **UNIT LOUVER** (left side of the button).

- Each time you push the button, unit numbers change as follows:

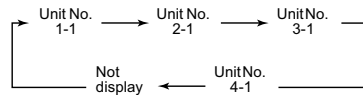

The fan of the selected unit runs and the louvers start swinging.

3 Select a swing type by pushing **TIME** buttons.

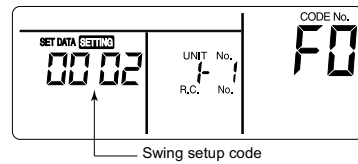

CAUTION

Do not set the swing setup code to "0000". (This setting may cause a failure of the louvers.)

4 Push the **SET** button.

5 Push the **TEST** button to finish the setting.

Swing setup code	Swing of louvers
0001	Standard swing (Factory default)
0002	Dual swing
0003	Cycle swing

Standard swing

All four louvers swing simultaneously at the same angle.

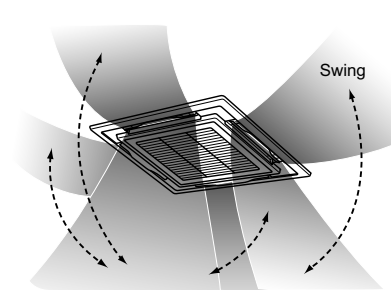

Cyclic swing (Recommended for cooling)

All four louvers swing at different times like waves.

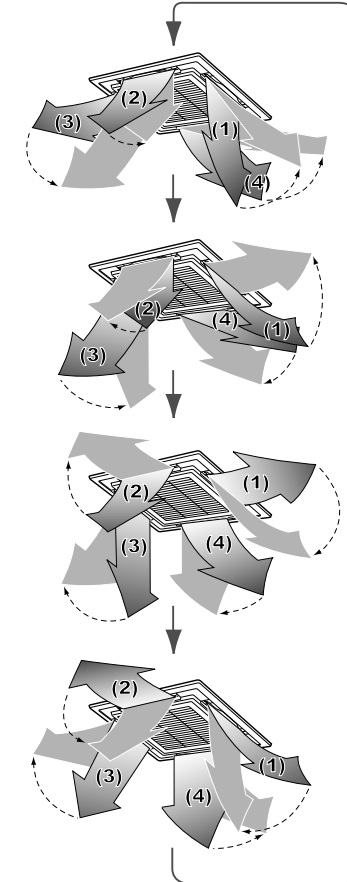

Dual swing

Adjoining louver alternately swing horizontally and downward.

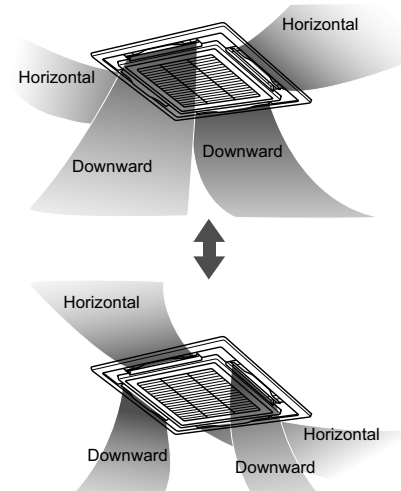

■ Setting the louver lock

1 Push and hold the  button (right side of the button) for at least 4 seconds while running is stopped.

SETTING blinks.

- When no unit number is displayed, all units are selected.

2 Push the  button (left side of the button) to select a unit.

The unit number changes each time you push the button.

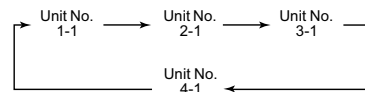

The fan of the selected unit runs, and the louver swings.

3 Push the “TEMP.  

The selected louver swings.

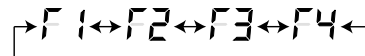

4 Push the  

Five numbered louver direction settings: (1) 0001, (2) 0002, (3) 0003, (4) 0004, and (5) 0005. Each is accompanied by a small diagram of a louver in a specific position.

- * If (4) or (5) is selected, condensation may occur during cooling.

5 Push the  button to confirm the setting.

When the setting is confirmed, the  mark lights up.

(To set the louver lock of another unit, repeat from Step 2. To set another louver lock of the same unit, repeat from Step 3.)

6 Push the  button to finish the setting.

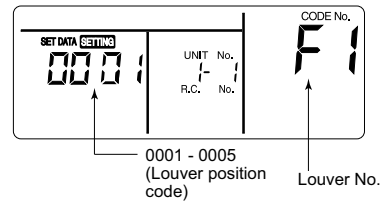

- * F1 appears in the CODE No. section on the remote controller. This indicates that the louver 01 shown in the following figure is selected.

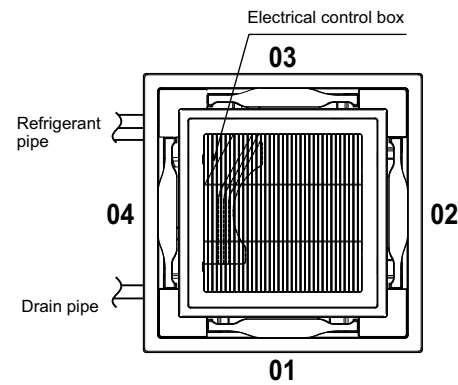

NOTE

Even in louver lock mode, the louver temporarily moves in the following cases:

- When the air conditioner is stopped

■ Releasing the louver lock



Set “0000” in Step 4 of “Setting the louver lock”.

The  mark disappears.

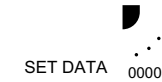
- * Steps 1 - 3 and 5, 6 of “Setting the louver lock” also apply to releasing the lock.



◆ Adjusting the horizontal direction

1 Push and hold the  and “TEMP.  

SETTING blinks.

“01” appears in CODE No.

2 Push the  button (left side of the button) to select a unit.

The unit number changes each time you push the button.

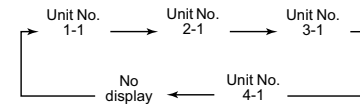

The fan of the selected unit runs, and the louver swings.

3 Push the “TEMP.  

4 Push the “TIME  

Direction SET DATA	Direction setting
“0000”	Smudging reduction position (reduces ceiling smudging)
“0002”	Cold draft position (Less directly expose your body to cool air) (factory default)

5 Push the  button to check the settings.

The indicator stops blinking and stays lit, and the settings are confirmed.

6 Push  button to finish the setting.

- * If the cold draft position is selected, the ceiling smudging reduction effect will be reduced.

10 Maintenance

⚠ WARNING

Cleaning the air filter and other parts of the air filter involves dangerous work in high places, so be sure to have a qualified installer or qualified service person to do it. Do not attempt it by yourself.

After the cooling or dry auto (cooling) operation has finished, the dry operation is performed and the fan starts running. When cleaning the unit, stop the drying operation forcibly and turn off the circuit breaker to avoid electric shock.

Cleaning air filters

Clogged air filters will reduce the cooling and heating performance.

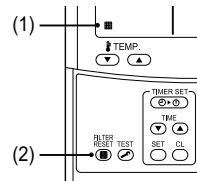

- (1) If "■" is displayed on the remote controller, clean the air filters.
- (2) When the cleaning of air filters has been completed, push button. "■" disappears.

When the unit will not be used for a long time

1. Perform the fan operation for a couple of hours to dry inside.
2. Press on the remote controller to stop running, and turn off the circuit breaker.
3. Clean the air filters and reinstall them.

Before the cooling season

Clean the drain pan

- Contact the dealer where you purchased the product.
(Drain does not work if the drain pan or vent is clogged. In some cases the drain may overflow and wet the wall or floor. Be sure to clean the drain pan before the cooling season.)

Check periodically

- If the unit is used for a long time, parts may deteriorate and cause malfunction or bad drainage of dehumidified water depending on the heat, humidity, or dust.
- In addition to the usual maintenance, it is recommended that you have the unit checked and maintained by the dealer where you purchased it.

NOTE

For environmental conservation, it is strongly recommended that the indoor and outdoor units of the air conditioner in use be cleaned and maintained regularly to ensure efficient operation of the air conditioner. When the air conditioner is operated for a long time, periodic maintenance (once a year) is recommended. Furthermore, regularly check the outdoor unit for rust and scratches, and remove them or apply rustproof treatment, if necessary. As a general rule, when an indoor unit is operated for 8 hours or more daily, clean the indoor unit and outdoor unit at least once every 3 months. Ask a professional for this cleaning / maintenance work. Such maintenance can extend the life of the product though it involves the owner's expense. Failure to clean the indoor and outdoor units regularly will result in poor performance, freezing, water leakage, and even compressor failure.



Maintenance List

Part	Unit	Check (visual / auditory)	Maintenance
Heat exchanger	Indoor / outdoor	Dust / dirt clogging, scratches	Wash the heat exchanger when it is clogged.
Fan motor	Indoor / outdoor	Sound	Take appropriate measures when abnormal sound is generated.
Filter	Indoor	Dust / dirt, breakage	<ul style="list-style-type: none"> • Wash the filter with water when it is contaminated. • Replace it when it is damaged.
Fan	Indoor	<ul style="list-style-type: none"> • Vibration, balance • Dust / dirt, appearance 	<ul style="list-style-type: none"> • Replace the fan when vibration or balance is terrible. • Brush or wash the fan when it is contaminated.
Air intake / discharge grilles	Indoor / outdoor	Dust / dirt, scratches	Fix or replace them when they are deformed or damaged.
Drain pan	Indoor	Dust / dirt clogging, drain contamination	Clean the drain pan and check the downward slope for smooth drainage.
Ornamental panel, louvers	Indoor	Dust / dirt, scratches	Wash them when they are contaminated or apply repair coating.
Exterior	Outdoor	<ul style="list-style-type: none"> • Rust, peeling of insulator • Peeling / lift of coat 	Apply repair coating.

11 Troubleshooting

Check the points described below before requesting repair.

	Symptom	Cause
It is not a malfunction.	Outdoor unit <ul style="list-style-type: none"> White, misty, cold air or water comes out Sometimes the noise of air leaking is heard. A noise is heard when the power is turned on. 	<ul style="list-style-type: none"> The fan of the outdoor unit is automatically stopped and defrosting is performed. The solenoid valve works when defrosting starts or stops. The outdoor unit is preparing for running.
	Indoor unit <ul style="list-style-type: none"> Sometimes a swishing is heard. A clacking sound is heard. Discharged air smells unusual. The fan continues running even after the unit operation is stopped. 	<ul style="list-style-type: none"> When the unit starts running, during operation, or immediately after the unit stops running, a sound such as water flowing may be heard, or the operation sound may become louder for a couple of minutes immediately after the unit starts running. This is the sound of the refrigerant flowing or the dehumidifier draining. This is a sound generated when the heat exchanger, etc. expands and contracts slightly due to temperature change. Various smells from the walls, carpet, clothes, cigarette, cosmetics, etc. adhere to the air conditioner. The fan keeps running to self clean operation the heat exchanger during drying.
	<ul style="list-style-type: none"> The unit does not run 	<ul style="list-style-type: none"> Has a blackout occurred? Has the circuit breaker blown? Has the protective device been activated? (The operation indicator and  on the remote controller are blinking.)
Check again.	The room does not cool down or warm up.	<ul style="list-style-type: none"> Is the air intake or discharge of the outdoor unit clogged? Is a door or window open? Is the air filter clogged with dust? Is the air volume set to "Low"? Or is the operation mode set to "Fan"? Is the setup temperature appropriate?

If there is something unusual even after checking the above, stop running the unit, turn off the circuit breaker, and inform the dealer where you purchased the product of the product number and symptom. Do not attempt to repair the unit by yourself as doing so is dangerous. If the check indicator (, , , etc.) is displayed on the remote controller LCD, inform the dealer of its content as well.

If any of the following occur, stop running the unit immediately, turn off the circuit breaker, and contact the dealer where you purchased the product.

- The switch does not work properly.
- The circuit breaker often blows out.
- You unintentionally put a foreign object or water inside.
- The unit cannot be run even after the cause of the protective device activation is removed.
- Other unusual conditions are found.

Confirmation and check

When an error occurred in the air conditioner, an error code and indoor UNIT No. appear on the display part of the remote controller.

The error code is only displayed during the operation. If the display disappears, operate the air conditioner according to the following "Confirmation of error log" for confirmation.

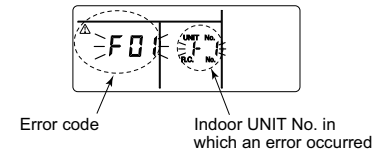

Confirmation of error log

When an error occurred on the air conditioner, the error log can be confirmed with the following procedure. (The error log is stored in memory up to 4 errors.)

The log can be confirmed from both operating status and stop status.

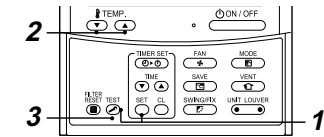

1 When  and  buttons are pushed at the same time for 4 seconds or more, the following display appears.

If  is displayed, the mode enters in the error log mode.

- [01: Order of error log] is displayed in CODE No..
- [Error code] is displayed in CHECK.
- [Indoor unit address in which an error occurred] is displayed in Unit No.

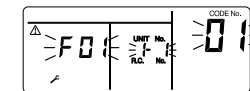

2 Every pushing of  button used to set temperature, the error log stored in memory is displayed in order.

The numbers in CODE No. indicate CODE No. [01] (latest) → [04] (oldest).

REQUIREMENT

Do not push  button because all the error log of the indoor unit will be deleted.

3 After confirmation, push  button to return to the usual display.

12 Operations and performance

▼ Check before running

- Check whether the earth wire is cut or disconnected.
- Check whether the air filter is installed.
- Turn on the circuit breaker 12 hours or more before starting operation.

▼ 3 minutes protection function

3-minutes protection function prevents the air conditioner from starting for initial 3 minutes after the main power switch / circuit breaker is turned on for re-starting the air conditioner.

▼ Power failure

Power failure during operation will stop the unit completely.

- To restart the operation, push the ON / OFF button on the remote controller.
- Lightning or a wireless car telephone operating nearby may cause the unit to malfunction. Turn off the main power switch or circuit breaker and then turn them on again. Push the ON / OFF button on the remote controller to restart.

▼ Defrosting operation

If the outdoor unit is frosted during the heating operation, defrosting starts automatically (for approximately 2 to 10 minutes) to maintain the heating capacity.

- The fans in both indoor and outdoor units will stop during the defrosting operation.
- During the defrosting operation, the defrosted water will be drained from the bottom plate of the outdoor unit.

▼ Heating capacity

In the heating operation, the heat is absorbed from the outside and brought into the room. This way of heating is called heat pump system. When the outside temperature is too low, it is recommended to use another heating apparatus in combination with the air conditioner.

▼ Air conditioner operating conditions

For proper performance, operate the air conditioner under the following temperature conditions:

Cooling operation	Outdoor temperature	: -15 °C to 43 °C (Dry bulb temp.)
	Room temperature	: 21 °C to 32 °C (Dry bulb temp.), 15 °C to 24 °C (Wet bulb temp.)
	[CAUTION]	Room relative humidity – less than 80 %. If the air conditioner operates in excess of this figure, the surface of the air conditioner may cause dewing.
Heating operation	Outdoor temperature	: -15 °C to 15 °C (Wet bulb temp.)
	Room temperature	: 15 °C to 28 °C (Dry bulb temp.)

If air conditioner is used outside of the above conditions, safety protection may work.

▼ Protective device

- Stops operation when the air-conditioner is overloaded.
- If the protective device is activated, the unit stops running, and the operation indicator and check indicator on the remote controller blink.

▼ If the protective device is activated

- Turn off the circuit breaker and perform a checkup. Continued running may cause a malfunction.
- Check whether the air filter is installed. If not, the heat exchanger may be clogged with dust and water leakage may occur.

▼ During cooling

- The air intake or discharge of the outdoor unit is clogged.
- Strong wind continuously blows against the discharge of the outdoor unit.

▼ During heating

- The air filter is clogged with a large amount of dust.
- The air intake or discharge of the indoor unit is clogged.

▼ Do not turn off the circuit breaker

During the air-conditioning season, leave the circuit breaker turned on, and use the ON / OFF key on the remote controller.

▼ Attention to snowfall and freeze on the outdoor unit

- In snowy areas, the air intake and air discharge of the outdoor unit are often covered with snow or frozen up. If snow or freeze on the outdoor unit is left as it is, it may cause machine failure or poor warming.
- In cold areas, pay attention to the drain hose so that it perfectly drains water without water remaining inside for freeze prevention. If water freezes in the drain hose or inside the outdoor unit, it may cause machine failure or poor warming.

13 Installation

Do not install the air conditioner in the following places

- Do not install the air conditioner in any place within 1 m from a TV, stereo, or radio set. If the unit is installed in such place, noise transmitted from the air conditioner affects the operation of these appliances.
- Do not install the air conditioner near a high frequency appliance (sewing machine or massager for business use, etc.), otherwise the air conditioner may malfunction.
- Do not install the air conditioner in locations where iron or other metal dust is present. If iron or other metal dust adheres to or collects on the interior of the air conditioner, it may spontaneously combust and start a fire.
- Do not install the air conditioner in a humid or oily place, or in a place where steam, soot, or corrosive gas is generated.
- Do not install the air conditioner in a salty place such as seaside area.
- Do not install the air conditioner in a place where a great deal of machine oil is used.
- Do not install the air conditioner in a place where it is usually exposed to strong wind such as in seaside area.
- Do not install the air conditioner in a place where sulfurous gas generated such as in a spa.
- Do not install the air conditioner in a vessel or mobile crane.
- Do not install the air conditioner in an acidic or alkaline atmosphere (in a hot-spring area or near a chemicals factory, or in a place subject to combustion emissions). Corrosion may be generated on the aluminum fin and copper pipe of the heat exchanger.
- Do not install the air conditioner near an obstacle (air vent, lighting equipment, etc.) that disturbs discharge air. (Turbulent airflow may reduce the performance or disable devices.)
- Do not use the air conditioner for special purposes such as preserving food, precision instruments, or art objects, or where breeding animals or growing plants are kept. (This may degrade the quality of preserved materials.)
- Do not install the air conditioner over an object that must not get wet. (Condensation may drop from the indoor unit at a humidity of 80 % or more or when the drain port is clogged.)
- Do not install the air conditioner in a place where an organic solvent is used.
- Do not install the air conditioner near a door or window subject to humid outside air. Condensation may form on the air conditioner.
- Do not install the air conditioner in a place where special spray is used frequently.

Be careful with noise or vibrations

- Do not install the air conditioner in a place where noise by outdoor unit or hot air from its air discharge annoys your neighbors.
- Install the air conditioner on a solid and stable foundation so that it prevents transmission of resonating, operation noise and vibration.
- If one indoor unit is operating, some sound may be audible from other indoor units that are not operating.

14 Specifications

Model	Sound power level (dBA)		Weight (Kg) Main unit (Ceiling panel)
	Cooling	Heating	
RAV-SM564UTP-E	*	*	20 (4.2)
RAV-SM804UTP-E	*	*	20 (4.2)
RAV-SM1104UTP-E	*	*	24 (4.2)
RAV-SM1404UTP-E	*	*	24 (4.2)
RAV-SM1604UTP-E	*	*	24 (4.2)

* Under 70 dBA

Declaration of Conformity

Manufacturer: **TOSHIBA CARRIER (THAILAND) CO., LTD.**
144 / 9 Moo 5, Bangkadi Industrial Park, Tivanon Road,
Amphur Muang, Pathumthani 12000, Thailand

Authorized Representative / TCF holder: Nick Ball
Toshiba EMEA Engineering Director
Toshiba Carrier UK Ltd.
Porsham Close, Belliver Industrial Estate,
PLYMOUTH, Devon, PL6 7DB.
United Kingdom

Hereby declares that the machinery described below:

Generic Denomination: Air Conditioner

Model / type: RAV-SM564UTP-E
RAV-SM804UTP-E
RAV-SM1104UTP-E
RAV-SM1404UTP-E
RAV-SM1604UTP-E

Commercial name: Digital Inverter Series Super Digital Inverter Series Air Conditioner

Complies with the provisions of the "Machinery" Directive (Directive 2006 / 42 / EC) and the regulations transposing into national law

Complies with the provisions of the following harmonized standard:

EN 378-2: 2008+A2:2012

NOTE

This declaration becomes invalid if technical or operational modifications are introduced without the manufacturer's consent.

Information according to EMC Directive 2004 / 108 / EC	
(Name of the manufacturer)	TOSHIBA CARRIER (THAILAND) CO., LTD.
(Address, city, country)	144 / 9 Moo 5, Bangkadi Industrial Park, Tivanon Road, Amphur Muang, Pathumthani 12000, Thailand
(Name of the Importer / Distributor in EU)	Toshiba Carrier UK Ltd.
(Address, city, country)	Porsham Close, Belliver Industrial Estate, PLYMOUTH, Devon, PL6 7DB. United Kingdom

TOSHIBA CARRIER (THAILAND) CO.,LTD.

**144/9 MOO 5, BANGKADI INDUSTRIAL PARK, TIVANON ROAD, TAMBOL BANGKADI,
AMPHUR MUANG, PATHUMTHANI 12000, THAILAND.**

1114119601