

TOSHIBA OWNER'S MANUAL

AIR CONDITIONER (SPLIT TYPE)

For general public use

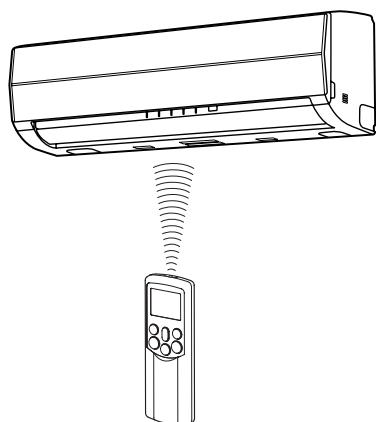

Indoor Unit	Outdoor Unit
RAS-B10SKVP-E RAS-B13SKVP-E RAS-B16SKVP-E	RAS-10SAVP-E RAS-13SAVP-E RAS-16SAVP-E RAS-M14GAV-E RAS-M18GAV-E
RAS-M10SKCVP-E RAS-M13SKCVP-E RAS-M16SKCVP-E	RAS-M14GACV-E RAS-M18GACV-E

Thank you for purchasing this TOSHIBA Air Conditioner. Please read this owner's manual carefully before using your Air Conditioner.

CONTENTS

ENGLISH

ACCESSORIES.....	1
SAFETY PRECAUTIONS.....	1
NAMES OF PARTS.....	4
NAMES AND FUNCTIONS OF INDICATORS AND CONTROLS ON INDOOR UNIT.....	4
REMOTE CONTROLLER AND ITS FUNCTIONS.....	5
NAMES AND FUNCTIONS OF INDICATORS ON REMOTE CONTROLLER.....	6
PREPARATION AND CHECK BEFORE USE.....	6
USING THE REMOTE CONTROLLER.....	8
AUTOMATIC OPERATION.....	9
AUTOMATIC OPERATION (AUTO CHANGEOVER).....	9
COOLING/HEATING OPERATION.....	10
DRY OPERATION.....	10
FAN ONLY OPERATION (cooling-only models only).....	10
PURE OPERATION.....	11
Hi POWER OPERATION.....	12
1, 3, 5, 9H OFF TIMER.....	12
TIMER OPERATION.....	13
MEMORY/MY COMFORT OPERATION.....	15
ADJUSTING AIR FLOW DIRECTION.....	16
AUTO RESTART OPERATION.....	17
HOW THE AIR CONDITIONER WORKS.....	18
TEMPORARY OPERATION.....	19
CLEANING OPERATION.....	19
USUAL MAINTENANCE.....	20
SPECIAL MAINTENANCE.....	22
AIR CONDITIONER OPERATION AND PERFORMANCE.....	24
TROUBLESHOOTING.....	25
SPECIFICATIONS.....	28
TROUBLESHOOTING (Remote Controller).....	29

About indoor unit and outdoor unit combinations

- The **RAS-B10SKVP-E**, **RAS-B13SKVP-E** and **RAS-B16SKVP-E** indoor units can be connected to a single outdoor unit or a multi outdoor unit.

For single unit connection

Use the following combinations.

RAS-B10SKVP-E/RAS-10SAVP-E

RAS-B13SKVP-E/RAS-13SAVP-E

RAS-B16SKVP-E/RAS-16SAVP-E

For multi unit connection

Refer to the specifications included with the multi outdoor unit.

- The **RAS-M10SKCVP-E**, **RAS-M13SKCVP-E** and **RAS-M16SKCVP-E** indoor units can be connected to a multi outdoor unit. Refer to the specifications included with the multi outdoor unit.

About indoor unit model names

Heat pump models

(**RAS-B10SKVP-E**, **RAS-B13SKVP-E** and **RAS-B16SKVP-E**)

These indoor units can perform both cooling and heating operation.

Cooling-only models

(**RAS-M10SKCVP-E**, **RAS-M13SKCVP-E** and

RAS-M16SKCVP-E)

These indoor units are cooling-only models, and cannot perform heating operation.

ACCESSORIES

Remote controller

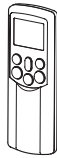

Remote controller holder



Batteries (two)



SAFETY PRECAUTIONS

This appliance is not intended for use by person (including children) with reduced physical, sensory or mental capabilities, or lack of experience and knowledge, unless they have been given supervision or instruction concerning use of the appliance by a person responsible for their safety.

DANGER

- DO NOT ATTEMPT TO INSTALL THIS UNIT BY YOURSELF. THIS UNIT REQUIRES A QUALIFIED INSTALLER.
- DO NOT ATTEMPT TO REPAIR THE UNIT BY YOURSELF. THIS UNIT SHOULD BE PROFESSIONALLY REPAIRED.
- OPENING OR REMOVING THE COVER WILL EXPOSE YOU TO DANGEROUS VOLTAGES.
- TURNING OFF THE POWER SUPPLY WILL NOT PREVENT POTENTIAL ELECTRIC SHOCK.

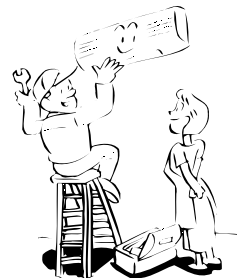

WARNING ⚠

INSTALLATION WARNINGS

- Be sure to ask a dealer or a store specialized in electric work to install the air conditioner.
- If the air conditioner is improperly installed by yourself, it can cause some problems such as water leaks, electric shock, fire, and so on.
- Be sure to always ground the air conditioner.
- Please request the dealer or a specialized technician to perform the grounding work. If the grounding work is performed improperly, an electric shock can result.
- Do not connect the ground wire to gas pipes, water pipes, lightning rods or ground wires of telephones. If the air conditioner is improperly grounded, it can cause an electric shock.
- Be sure to cover the pipe hole in the indoor unit panel if they are not used when re-installing the unit after moving or other operations. If the electrical parts inside the unit are touched, an injury or electric shock can result.
- Be sure that the power supply has dedicated air conditioner circuit at the rated voltage. Otherwise, a breakdown or fire can result.
- Do not install in locations where the unit will get splashed by water or with high humidity such as bathrooms. This can cause deterioration of the insulation, resulting in an electric shock or fire.

CAUTION

TO DISCONNECT THE APPLIANCE FROM THE MAIN POWER SUPPLY

A switch or circuit breaker that can disconnect all poles must be included in the fixed wiring. Be sure to use an approved circuit breaker or switch.

OPERATION WARNINGS

- Avoid cooling the room too strongly or exposing yourself to cool wind for a long time because it can be detrimental to your health.
- Never insert fingers or sticks into the air outlet and air inlet to avoid getting injured and damaging the machine because there are fans running at a high speed inside both the air inlet and air outlet.
- When you notice something unusual with the air conditioner (such as a burning smell or weak cooling power), immediately turn off the main switch and the circuit breaker from the main power supply to stop the air conditioner, and contact the dealer.
- If the air conditioner is operated continuously when something is wrong, it can cause machine failure, electric shock, fire, and so on.
- Do not spill water or other liquid on the indoor unit. If the unit is wet, it can cause an electric shock.
- If the air conditioner has poor cooling or heating performance, a refrigerant leak may be the cause. Therefore, please contact the dealer. The refrigerant itself used in this air conditioner is safe. Although the refrigerant normally does not leak, in the event that it does leak, toxic gas can be generated if it comes into contact with a flame such as from a fan heater, oven, or stove burner.
- Never turn the circuit breaker on or off, or operate the buttons when your hands are wet. An electric shock can result.
- Do not stop the air conditioner by setting the circuit breaker to off. To stop operation, press the stop button on the remote control. An electric shock or fire can result.
- Never try to clean the inside of the air conditioner yourself. Please request the dealer to clean inside the air conditioner. If the cleaning inside the unit is not performed properly, the plastic parts or insulation for the electrical parts can be damaged, resulting in a water leak, electric shock, or fire.
- If water or a foreign object gets inside the unit, immediately stop operation, and set the circuit breaker to off. Continued usage can result in a fire or electric shock. Please request repair from the dealer where you made the purchase.

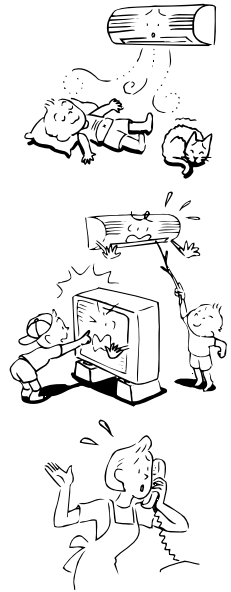

MOVEMENT AND REPAIR WARNINGS

- Do not attempt to move or repair the unit by yourself.
- Do not disassemble the unit. As there is high voltage inside the unit, you may receive an electric shock.
- Always ask the dealer to move the air conditioner for re-installing it in another place. If it is improperly installed, it can cause electric shock or fire.
- Whenever the air conditioner needs repairs, request repairs from the dealer. If the air conditioner is repaired improperly it can cause an electric shock or fire.

CAUTION

INSTALLATION CAUTIONS

- Securely lay the drain hose for the best draining results. Incorrect drainage can cause flooding in the house and furniture to get wet.
- Do not install the unit in a place where inflammable gas can leak. A fire can result if inflammable gas accumulates around the unit.
- The indoor unit shall be installed so that the top of the indoor unit is at least 2 m in height. Also, avoid putting anything on the top of the indoor unit.
- Do not place other electrical products, furniture, or other objects below the unit. Water droplets can fall, resulting in stains or damage.
- Check that the earth leakage breakers are installed correctly. Improperly installation of the earth leakage breakers can result in an electric shock. For the checking procedure, please contact the dealer who performed the installation, or a specialized installation dealer.

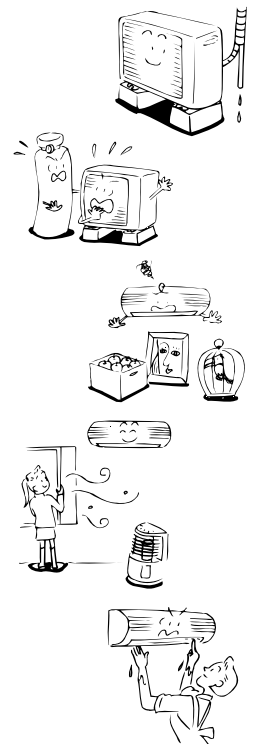

OPERATION CAUTIONS

- Carefully read this manual before starting the air conditioner. The manual includes a lot of important information for daily operation.
- Do not use this air conditioner for other purposes such as preserving food, precision instruments, art objects, breeding animals, or growing potted plants.
- Do not install this air conditioner in a special-purpose room such as a ship or any kind of vehicle. Doing so could harm machine performance.
- Avoid exposing potted plants and animals to wind from the air conditioner because it harms their health and growth.
- When the air conditioner is operated in close proximity to a combustion device, pay careful attention to ventilation and let fresh air into the room. Poor ventilation can cause an oxygen shortage.
- When the air conditioner is used in a closed room, pay careful attention to the ventilation of the room. Poor ventilation can cause an oxygen shortage.
- Do not touch the operation buttons with wet hands. Doing so could cause an electric shock.

- Do not place any combustion device in a place where it is directly exposed to wind from the air conditioner. Doing so could cause incomplete combustion.
 - When the air conditioner is not to be used for an extended period of time, turn off the main switch or the circuit breaker for added safety. Disconnecting from the power supply protects the unit from lightning and power surges.
 - Do not put a container with water such as a vase on the unit because water can enter into the unit and cause an electric shock due to deterioration in the electric insulation.
 - Check the concrete blocks underneath the outdoor unit occasionally. If the base is left damaged or deteriorated, the unit can topple over and could possibly cause an injury.
 - Do not wash the unit with water. This could cause an electric shock.
 - Before cleaning the unit, be sure to turn off the main switch or circuit breaker to prevent injuries from the electric fan running inside.
 - Do not put anything on or step on the indoor unit and outdoor unit. If you do so, it can topple over and cause an injury.
 - To allow the air conditioner to operate at maximum performance, operate within the operating temperature range specified in the instructions. Failure to do so can cause a malfunction, break down, or water to leak from the unit.
 - It is recommended that maintenance be performed by a specialist when the unit has been operated for a long time.
 - If this indoor unit is connected to the multi outdoor unit and the heating is operated on multiple indoor units at the same time, when the outside temperature is low it may not be possible to obtain a sufficient airflow temperature. In locations where this is likely to occur, we recommend using the unit in combination with other heating equipment.
 - Do not touch the metal parts of the main unit when the front panel is removed. An injury can result.
 - Do not touch the inlets or aluminum fins of the unit. An injury could result.
 - Do not run for extended periods at high humidity (80% or higher) such as with a window or door open. Condensation can form on the indoor unit, causing it to drip onto furniture and other objects.
 - If there is a danger of a lightning strike, stop operation and set the circuit breaker to off. If lightning strikes, a breakdown of the unit can occur.
 - After washing the front panel, air filter, and dust collector with water, wipe up any remaining moisture, and dry. If any moisture is left, an electric shock can occur.
 - When removing the front panel, air filter, and dust collector, do not stand on an unstable platform. You could fall, and an injury could result.
 - Do not place objects around the outdoor unit, and keep it clear of fallen leaves. If fallen leaves and other objects collect around the outdoor unit, small animals can come and get inside the unit and touch its electrical parts. This could cause a breakdown of the unit or a fire.
 - Remote control batteries
 - Insert with the polarity signs (+ and -) in the correction orientation.
 - Do not recharge.
 - Do not leave batteries in the remote control that have exceeded the recommended usage period displayed on the battery or that are used up.
 - Do not mix different types of batteries or old and new batteries.
 - Do not solder directly on the batteries.
 - Do not short-circuit, disassemble, heat, or put the batteries in a fire.
- Failure to observe these points can cause the fluid to leak or the battery to crack open, resulting in a burn or injury. If you come into contact with the battery fluid, wash it off thoroughly with water. If it has spilled on a device, wipe off the fluid without directly touching it.
- Keep the batteries in a location out of the reach of small children. If a battery is swallowed by a small child, immediately contact a physician.

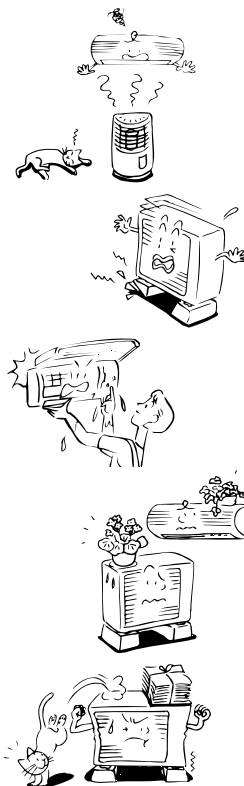

NAMES OF PARTS

Outdoor unit

- ① Refrigerant connecting pipe and electric wires
- ② Air inlet (Side and rear)
- ③ Air outlet

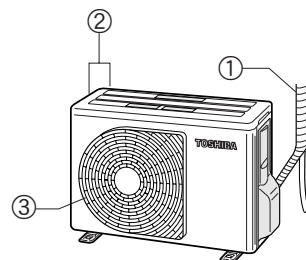

Indoor unit

- ④ Room temperature sensor
- ⑤ Front panel
- ⑥ Air inlet grille
- ⑦ Air filter
- ⑧ Air outlet
- ⑨ Horizontal air flow louver
Located at the back of the vertical air flow louver.
- ⑩ Vertical air flow louver
- ⑪ Display panel
- ⑫ Infrared signal receiver
- ⑬ Remote controller
- ⑭ Plasma pure filter

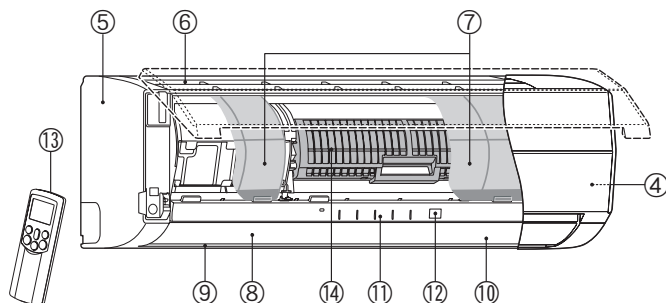

NAMES AND FUNCTIONS OF INDICATORS AND CONTROLS ON INDOOR UNIT

Display panel

The operating states are shown below.

- ① RESET button
- ② FILTER indicator (Orange)
- ③ TIMER indicator (Yellow)
- ④ PURE indicator (Blue)
- ⑤ OPERATION indicator (Green)
The operation indicators flash rapidly (5 times per second) when a safety protection feature is activated.
- ⑥ S.CLEAN indicator (Green)
When the unit shuts down after having operated for 10 or more minutes in the cooling or dry mode, the cleaning operation is started automatically, and the S.CLEAN indicator turns on.

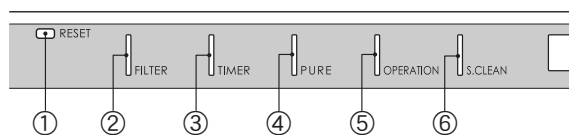



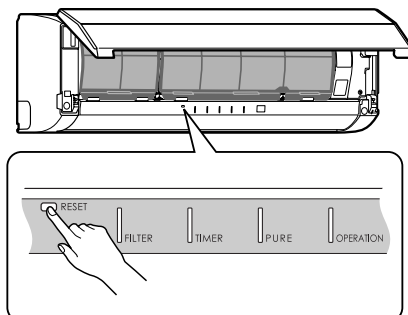

RESET button

The RESET button has the following two functions.

- Reset function
Use when the FILTER indicator (orange) is on. (☞ see page 21.)
- Temporary operation function
Use when you misplace or lose the remote controller, or when its batteries are used up. (☞ see page 19.)



REMOTE CONTROLLER AND ITS FUNCTIONS

- ① **Infrared signal transmitter**
Transmits signals to the indoor unit.
- ② **⏻ button**
Press the button to start operation. (A receiving beep is heard.) Press the button again to stop operation. (A receiving beep is heard.)
If no receiving sound is heard from the indoor unit, press the button again.
- ③ **Mode select button (MODE)**
Press this button to select a mode. Each time you press the button, the modes cycle in order from A: Auto changeover control, ❄️: COOL, ☀️: DRY, 🔥: HEAT (heat pump models only), 🌀: FAN ONLY (cooling-only models only) and back to A.
(A receiving beep is heard.)
- ④ **Temperature button (TEMP)**
▲ .. The temperature setting is raised to 30°C.
▼ ... The temperature setting is lowered to 17°C.
(A receiving beep is heard.)
- ⑤ **Fan speed button (FAN)**
Press this button to select the fan speed. When you select AUTO, the fan speed is automatically adjusted according to the room temperature. You can also manually select the desired fan speed from five available settings.
(LOW —, LOW+ — —, MED — — —, MED+ — — — —, HIGH — — — — —) (A receiving beep is heard.)
- ⑥ **Auto louver button (SWING)**
Press this button to swing the louver. (A receiving beep is heard.)
Press the button again to stop the louver from swinging. (A receiving beep is heard.) (☞ see page 16.)
- ⑦ **Set louver button (FIX)**
Press this button to adjust the air flow direction. (A receiving beep is heard.) (☞ see page 16.)
- ⑧ **ON timer button (ON)**
Use this button to change the clock and ON timer times.
To move up the time, press ▲ of the ON  button.
To move down the time, press ▼ of the ON  button.
- ⑨ **OFF timer button (OFF)**
Use this button to change the OFF timer times.
To move up the time, press ▲ of the OFF  button.
To move down the time, press ▼ of the OFF  button.
- ⑩ **Reserve button (SET)**
Press this button to store the time settings. (A receiving beep is heard.)
- ⑪ **Cancel button (CLR)**
Press this button to cancel the ON timer and OFF timer. (A receiving beep is heard.)
- ⑫ **High power button (Hi POWER)**
Press this button to start high power operation. (☞ see page 18.)
- ⑬ **Memory button (MEMO)**
Press this button to ready for storing the settings.
Hold down the button for 3 seconds or more to store the setting indicated on the remote controller and until the  mark is displayed. (☞ see page 15.)

- ⑭ **Automatic operation button (AUTO)**
Press this button to operate the air conditioner automatically.
(A receiving beep is heard.) (☞ see page 18.)
- ⑮ **SLEEP MODE button**
Press this button to start sleep mode. (☞ see page 18.)
- ⑯ **MY COMFORT button**
Press this button to operate the air conditioner according to the settings stored using the MEMO button. (☞ see page 15.)
- ⑰ **PURE button (PURE)**
Press this button to start the electrical air purifying operation.
Press the button again to stop operation.
- ⑱ **Off timer button (OFF)**
Press this button to start the OFF timer operation.
You can select the OFF timer time from among four settings (1, 3, 5 or 9 hours).

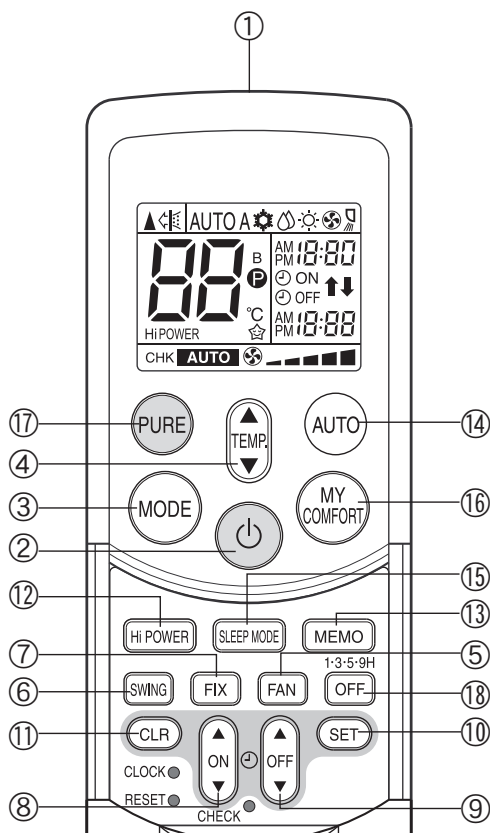

NAMES AND FUNCTIONS OF INDICATORS ON REMOTE CONTROLLER

Display

All indicators, except for the clock time indicator, are displayed by pressing the  button.

① Transmission mark

This transmission mark () indicates when the remote controller transmits signals to the indoor unit.

② Mode indicator

Indicates the current operation mode.

- Heat pump models
(AUTO: Automatic control, A: Auto changeover control, ❄️: COOL, 💧: DRY, ☀️: HEAT)
- Cooling-only models
(AUTO: Automatic control, A: Auto changeover control, ❄️: COOL, 💧: DRY, 🌀: FAN ONLY)





③ Temperature indicator

Indicates the temperature setting (17°C to 30°C).

④ PURE indicator

Shows that the electrical air purifying operation is in progress.

⑤ FAN speed indicator

Indicates the selected fan speed. AUTO or one of five fan speed levels (LOW , LOW+ , MED , MED+ , HIGH ) can be shown. Indicates AUTO when the operating mode is either AUTO or 💧: DRY.

⑥ TIMER and clock time indicator

The time setting for timer operation or the clock time is indicated.

The current time is always indicated except during TIMER operation.

⑦ Hi POWER indicator

Indicates when Hi POWER operation starts.

Press the Hi POWER button to start and press it again to stop operation.

⑧ (MEMORY) indicator

Flashes for 3 seconds when the MEMO button is pressed during operation.

The  mark is shown when holding down the button for 3 seconds or more while the mark is flashing.

Press another button to turn off the mark.

⑨ SLEEP MODE indicator

Indicates when the SLEEP MODE is activated.

Press the SLEEP MODE button to start and press it again to stop operation.

⑩ A. B change indicator remote controller

- When the remote controller switching function is set, "B" appears in the remote controller display. (When the remote controller setting is "A", there is no indication at this position.)

Remote controller switching function

- If two indoor units are installed in the same room or adjoining rooms, both units may start and stop at the same time when the remote controller is operated. This can be prevented by setting the switching function so that each indoor unit is operated only by the corresponding remote controller.
- To use the remote controller switching function, contact the air conditioner dealer or the installation company.

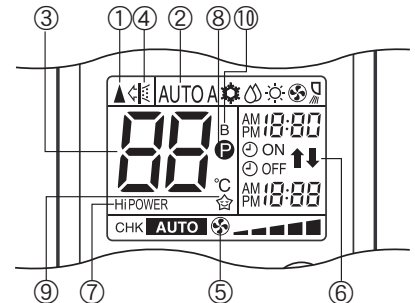

- In the illustration, all indicators are shown for purposes of explanation. During operation, only the relevant indicators are shown on the remote controller.

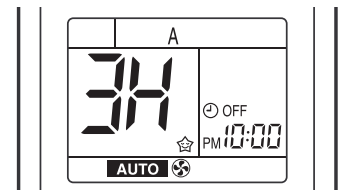

PREPARATION AND CHECK BEFORE USE

Loading the remote controller batteries

① Remove the cover, and insert the batteries.

② Press the RESET button.

The clock time indicator flashes. Press the RESET button using an object with a narrow tip.

③ Reattach the cover.

Removing the batteries

① Remove the cover, and take out the batteries.

② Reattach the cover.

* Please dispose of the batteries according to the local regulation.

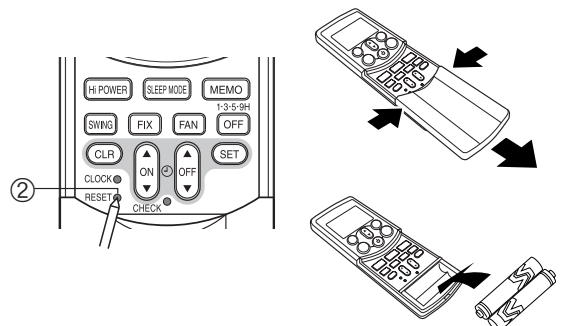

Batteries

- To replace the batteries, use two new batteries (AAA type).
- The batteries will last about one year under normal usage.
- Replace the batteries if there is no receiving beep from the indoor unit or when the air conditioner cannot be operated using the remote controller.
- To avoid malfunctions due to battery leakage, remove the batteries when not using the remote controller for over one month.
- Slide off the cover while pressing the sides.

Battery replacement

Be careful not to reverse the (+) position and the (-) position.

Setting the clock

Before you start operating the air conditioner, set the clock of the remote controller using the procedures given in this section. The clock panel on the remote controller will indicate the time regardless of whether the air conditioner is in use or not.

Initial setting

When batteries are inserted in the remote controller, the clock panel displays AM 0:00 and flashes.

① ON button

Press the ON  button to set the current time.

Each press of the ON button changes the time in one minute increments. Holding down the ON button changes the time in ten minute increments.

② SET button

Press the SET  button.

The current time is displayed and the clock starts.

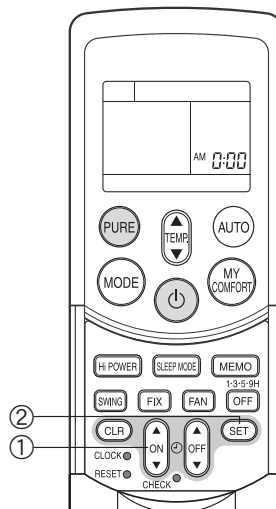

Adjusting the clock

① CLOCK button

Press the CLOCK button.

The clock time indicator flashes.

② ON button

Press the ON  button to set the current time.

Each press of the ON button changes the time in one minute increments.

Holding down the ON button changes the time in ten minute increments.

③ SET button

Press the SET  button.

The current time is displayed and the clock starts.

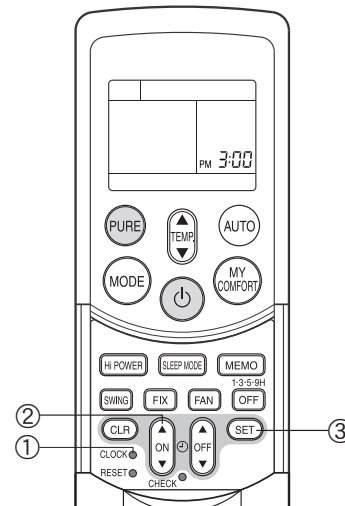
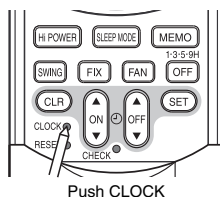

Check that the air filter and the plasma pure filter are correctly installed

- Press the plasma pure filter until the projections on both sides are fully inserted into the holders (tabs). If the installation is not correct, the FILTER indicator (orange) may come on.

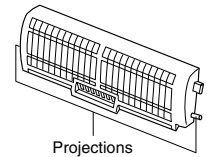

USING THE REMOTE CONTROLLER

CAUTION

- The air conditioner will not operate if curtains, doors or other objects block the signals from the remote controller to the indoor unit.
- Be careful that liquids do not spill onto the remote controller.
- Do not expose the remote controller to direct sunlight or heat.
If the infrared signal receiver on the indoor unit is exposed to direct sunlight, the air conditioner may not function properly. Use curtains to prevent sunlight from reaching the receiver.
- Signals may not be properly received, if the room using the air conditioner has fluorescent lighting with electronic starters. If you plan to use fluorescent lamps, consult with your local dealer.
- If other electrical appliances are activated by the remote controller, move these appliances or consult with your local dealer.

Location of the remote controller

- Keep the remote controller where its signals can reach the receiver of the indoor unit (a distance of up to 7 m is allowed).
- When you select timer operation, the remote controller automatically transmits a signal to the indoor unit at the specified time.
If you keep the remote controller in a location where proper signal transmission is blocked, a time lag of up to 15 minutes may occur.

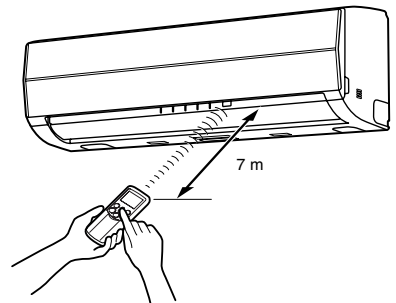

Remote controller holder

Installing the remote controller holder

- Before you actually install the remote controller holder on a wall or pillar, check whether the remote controller signals can be received by the indoor unit.

Mounting and removing the remote controller

- To mount the remote controller, hold it parallel to the remote controller holder and push it in fully. To remove the remote controller, slide the remote controller upwards and out from the holder.

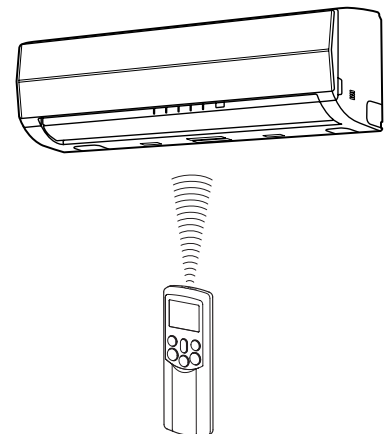
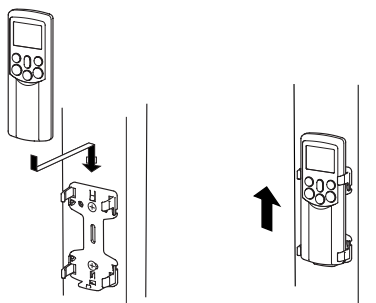

AUTOMATIC OPERATION

When you set the air conditioner to AUTO mode, it automatically selects cooling, heating (heat pump models only), or fan only operation depending on the room temperature. (☞ see page 18.)
The fan speed and louver are also automatically controlled.

Start

- ① **⏻ button**
Press this button to start the air conditioner.
- ② **AUTO button (AUTO)**
Press AUTO button.
- ③ **Temperature button (TEMP)**
Set the desired temperature.

- The OPERATION indicator (green) on the display panel of the indoor unit lights. The operating mode is selected according to the room temperature and operation starts after approximately 3 minutes.
- If the AUTO mode is uncomfortable, you can select the desired conditions manually. The fan speed and louver position can be changed, and MODE is also changed from AUTO to A when the fan speed or louver position is changed. The fan speed indicator is also shown.

Stop

- ⏻ button**
Press this button again to stop the air conditioner.

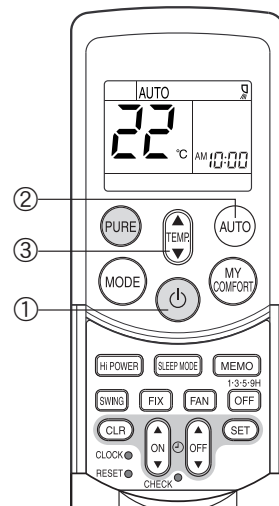

AUTOMATIC OPERATION (AUTO CHANGEOVER)

When you set the air conditioner to A mode or switch over from AUTO operation because of a change in settings, the air conditioner automatically selects cooling, heating (heat pump models only), or fan only operation depending on the room temperature. (☞ see page 18.)

Start

- ① **⏻ button**
Press this button to start the air conditioner.
- ② **Mode select button (MODE)**
Select A.
- ③ **Temperature button (TEMP)**
Set the desired temperature.
- ④ **Fan speed button (FAN)**
Select one of "AUTO" LOW —, LOW+ — —, MED — — —, MED+ — — — —, HIGH — — — — —.

- The OPERATION indicator (green) on the display panel of the indoor unit lights. The operating mode is selected according to the room temperature and operation starts after approximately 3 minutes.
- The temperature, fan speed and louver position can be changed. You can select the desired conditions manually.

Stop

- ⏻ button**
Press this button again to stop the air conditioner.

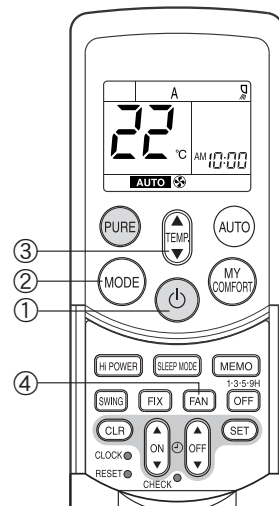

COOLING/HEATING OPERATION

Start

- ① **⏻ button**
Press this button to start the air conditioner.
 - ② **Mode select button (MODE)**
Select COOL ❄️ or HEAT 🔥 (heat pump models only).
 - ③ **Temperature button (TEMP)**
Set the desired temperature.
 - ④ **Fan speed button (FAN)**
Select one of "AUTO" LOW —, LOW+ — —, MED — — —, MED+ — — — —, HIGH — — — — —.
- The OPERATION indicator (green) on the display panel of the indoor unit turns on. Operation starts after approximately 3 minutes.

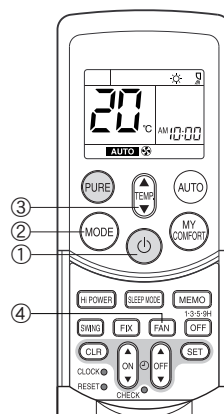

Stop

- ⏻ button**
Press this button again to stop the air conditioner.
- Heating operations cannot be performed by a cooling-only model.

DRY OPERATION

Start

- ① **⏻ button**
Press this button to start the air conditioner.
 - ② **Mode select button (MODE)**
Select DRY ☁️.
 - ③ **Temperature button (TEMP)**
Set the desired temperature.
- The fan speed setting is fixed to AUTO and the AUTO is displayed.
 - The OPERATION indicator (green) on the display panel of the indoor unit turns on, and operation starts after approximately 3 minutes.

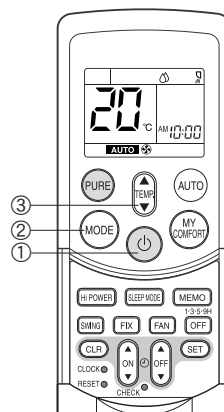

Stop

- ⏻ button**
Press this button again to stop the air conditioner.

FAN ONLY OPERATION (cooling-only models only)

Start

- ① **⏻ button**
Press this button to start the air conditioner.
 - ② **Mode select button (MODE)**
Select FAN ONLY 🌀.
 - ③ **Fan speed button (FAN)**
Select one of "AUTO" LOW —, LOW+ — —, MED — — —, MED+ — — — —, HIGH — — — — —.
- The OPERATION indicator (green) on the display panel of the indoor unit turns on. Operation will start immediately.
 - The 🌀: FAN ONLY mode does not control the temperature.

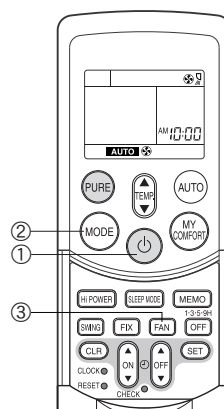

Stop

- ⏻ button**
Press this button again to stop the air conditioner.

PURE OPERATION

Press this button to start the electrical air purifying operation.

During air conditioner operation

① PURE button

PURE operation starts by pressing this button.

- The PURE indicator (blue) on the display panel of the indoor unit turns on.
- Plasma pure filter is activated.

To stop only PURE operation

PURE button

PURE operation stops by pressing this button.

- The PURE indicator (blue) on the display panel of the indoor unit turns off.
- Plasma pure filter is deactivated.

To stop air conditioner operation at the same time

⏻ button

Air conditioner operation and PURE operation stop by pressing this button.

- The OPERATION indicator (green) and PURE indicator (blue) on the display panel of the indoor unit turn off.

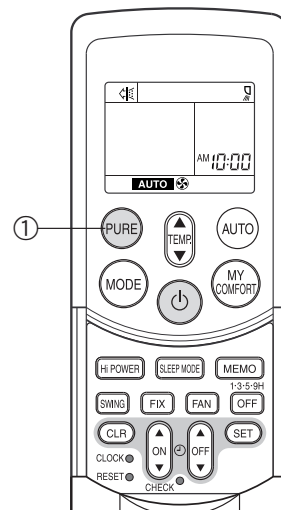

CAUTION

- When the ⏻ button is pressed the next time, operation starts with the combined air conditioner and PURE operation.
- During the combined air conditioner and PURE operation, air conditioner operation only cannot be stopped.

When the air conditioner is stopped

① PURE button

PURE operation starts by pressing this button.

- The PURE indicator (blue) on the display panel of the indoor unit turns on.

INFORMATION

- During PURE operation, a small amount of ozone is produced, and you might notice the smell.
- When the air flow is automatic, it changes between LOW — and MED+ —■■■■ .
LOW — operation is performed when the indoor air becomes clean. During operation, the position of the vertical air flow louvers may change if the room temperature is low.
- Opening the air inlet grille during PURE operation sometimes turns on the FILTER indicator (orange).
In this case, stop PURE operation (stop the air conditioner if it is also operating), and then close the air inlet grille.
- The FILTER indicator (orange) turns on after PURE operation is performed for about 1000 hours.
When the indicator turns on, clean the plasma pure filter. (☞ see page 22.)

Hi POWER OPERATION

High power (Hi POWER)

- The Hi POWER (high power operation) mode automatically controls room temperature, air flow and the operation mode so that the room is quickly cooled in summer and warmed in winter. (☞ see page 18.)

Setting Hi POWER mode

① Hi POWER button

Press the Hi POWER button. The Hi POWER mark on the remote controller is shown.

Canceling Hi POWER mode

① Hi POWER button

Press the Hi POWER button once again.

The Hi POWER mark on the remote controller turns off.

CAUTION

The Hi POWER mode cannot be activated during DRY operation and FAN ONLY operation (cooling-only models only).

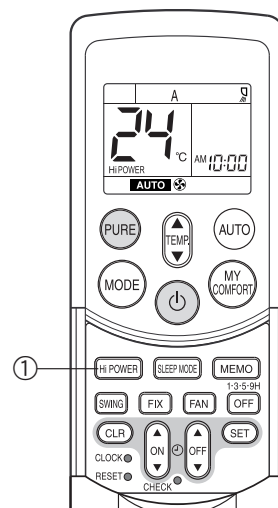

1, 3, 5, 9H OFF TIMER

The air conditioner stops after operating for the set time (1, 3, 5 or 9 hours).

① OFF button

Press the OFF button (during operation).

- There is a short beep and the timer indicator comes on. The time at which the air conditioner will stop is indicated on the remote controller display (1H: about 1 hour after the current time).
- Press the button again while 1H is displayed (about 3 seconds) to change to the 3H indicator, press again to change to the 5H indicator, and press again to change to the 9H indicator.
- After selecting the time you want, do not press this button again. (When the 1H, 3H, etc. indicator goes off the timer is set.)

② CLR button

Press the CLR button to cancel the timer.

- The timer is canceled but the air conditioner continues to operate.
- The 1, 3, 5 or 9H OFF timer operation is also canceled if the OFF button is pressed after making a setting.

INFORMATION

- Cleaning operation starts when the time of the 1, 3, 5 or 9H OFF timer is reached. (Cleaning operation is not performed during heating operation or the PURE operation.)
- When using in combination with the ON timer, first set the 1, 3, 5 or 9H OFF timer and then set the ON timer.
- If the OFF button is pressed while the ON (OFF) timer has been set, the ON (OFF) timer is canceled and only the 1, 3, 5 or 9H OFF timer is set.

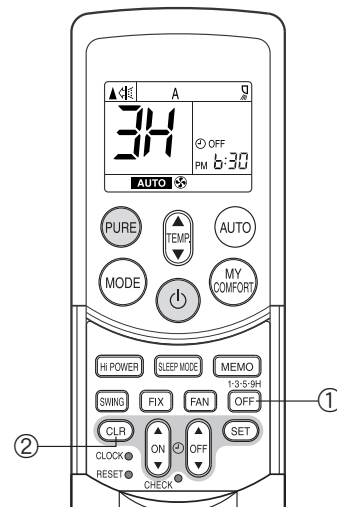

TIMER OPERATION

ON timer and OFF timer

Setting the ON Timer

① **ON**  button

Press the ON  button. Set the timer to the desired time.

Each time the ON button is pressed, the time changes in ten minute increments.
Holding down the ON button changes the time in one hour increments.

② **SET**  button

Press the SET  button to set the timer.
The timer time is displayed, and the timer starts.

③ **CLR**  button

Press the CLR  button to cancel the timer setting.

Setting OFF Timer

① **OFF**  button

Press the OFF  button.

Set the timer to the desired time.

Each time the OFF button is pressed, the time changes in ten minute increments.
Holding down the OFF button changes the time in one hour increments.

② **SET**  button

Press the SET  button to set the timer.
The timer time is displayed, and the timer starts.

③ **CLR**  button

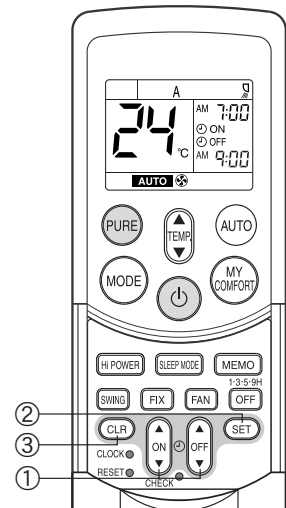

Press the CLR  button to cancel the timer setting.



CAUTION

- When you select timer operation, the remote controller automatically transmits the timer signal to the indoor unit at the specified time. Therefore, keep the remote controller in a location where it can transmit the signal to the indoor unit properly.
- If you do not press the SET  button within 30 seconds after setting the time, the setting will be cancelled.

Once you select timer operation mode, the settings are saved in the remote controller.

Thereafter, the air conditioner will start operating under the same conditions as you pressed the  or  button on the remote controller.

You cannot set the timer when the clock display is flashing.

Follow the instructions in the section "Setting the clock" on page 7 to set the clock, and then set the timer.

Combined timer (Setting the ON and OFF timers simultaneously)

OFF timer → ON timer



(Operation → Stop → Operation)

This feature is useful when you want to stop the air conditioner after you go to sleep, and start it again in the morning when you wake up or you return home.

Example:

To stop the air conditioner and start it again next morning

Setting combined TIMER

- (1) Press the OFF  button to set the OFF timer.
- (2) Press the ON  button to set the ON timer.
- (3) Press the SET  button.

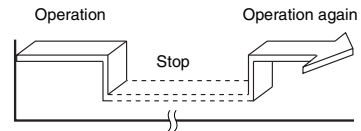

ON timer → OFF timer



(Stop → Operation → Stop)

You can use this setting to start the air conditioner when you wake up and stop it when you leave the house.

Example:

To start the air conditioner the next morning and stop it

Setting combined TIMER

- (1) Press the ON  button to set the ON timer.
- (2) Press the OFF  button to set the OFF timer.
- (3) Press the SET  button.

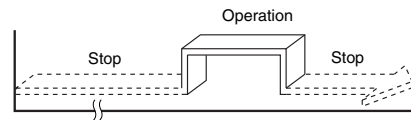

- The ON or OFF timer function that is closer to the current time is activated first.
- If the same time is set for both ON and OFF timers, no timer operation is performed. Also, the air conditioner may stop operating.





CAUTION

Approximately 3 seconds later, the remote controller will transmit the signal to the indoor unit and a receiving beep will sound from the indoor unit after you press the SET  button.

Daily combined timer (setting the ON and OFF timers simultaneously and activating every day)

This feature is useful when you want to use the combined timers at the same time every day.

Setting combined TIMER

- (1) Press the ON  button to set the ON timer.
- (2) Press the OFF  button to set the OFF timer.
- (3) Press the SET  button.
- (4) After step (3), an arrow mark (↑ or ↓) flashes for about 3 seconds. Press the SET  button during this flashing.

- Both arrows (↑, ↓) are shown while the daily timer is activated.

Cancelling timer operation

Press the CLR  button.

Clock display

During TIMER operation (ON-OFF, OFF-ON, OFF timer), the clock time indicator is not shown so the setting time can be displayed. To view the current time, press the SET button briefly and the current time will be displayed for about 3 seconds.

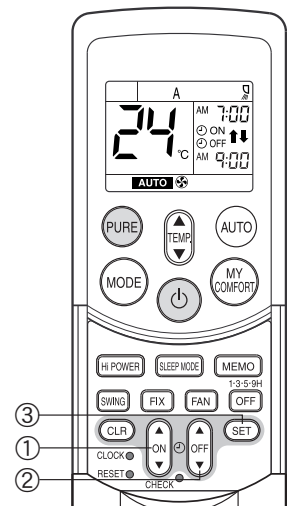

MEMORY/MY COMFORT OPERATION

Use the MEMO button to store a frequently used operation setting for convenience. Start the air conditioner in the operation mode that you want the remote controller to store.

Press the button as shown below while the air conditioner is operating.

① MEMO button

Press this button briefly to ready for storing the setting.

All the icons currently shown flash, except for the clock time indicator and mode indicator.

② MEMO button

Hold down the MEMO button for 3 seconds or more while the indicator flashes.

The **M** mark is shown and the setting is stored.

- If you do not press the MEMO button within 3 seconds or if you press another button, the MEMORY setting is cancelled.
- Operation modes which can be stored with the MEMO button are MODE, Temperature, FAN, TIMER and Hi POWER.

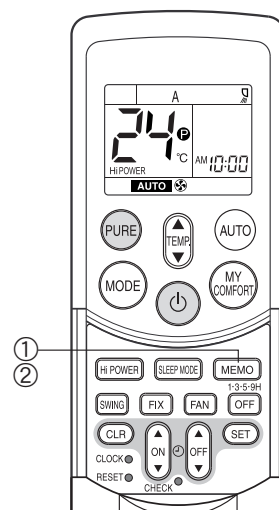

To operate the air conditioner with the setting stored using the MEMO button.

① MY COMFORT button

Press the MY COMFORT button. The setting stored with the MEMO button will be shown and the air conditioner operates based on the setting.

(A): When the MY COMFORT button is pressed while operation is stopped

- The OPERATION indicator (green) on the display panel of the indoor unit turns on, and operation starts after approximately 3 minutes.

(B): When the MY COMFORT button is pressed during operation

- The operation mode changes to the setting stored with the MEMO button.

• Initial setting:

MODE : AUTO
Temperature : 22

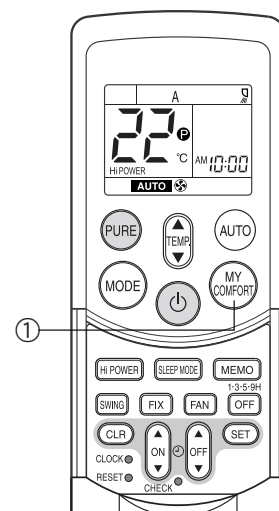

ADJUSTING AIR FLOW DIRECTION

- Adjust the air flow direction properly. Failure to do so could cause discomfort and make an uneven room temperature distribution.
- Adjust the vertical air flow using the remote controller.
- Adjust the horizontal air flow manually.

Adjusting the vertical air flow

The air conditioner automatically adjusts the vertical air flow direction according to the operating conditions when AUTO or A mode is selected.

To set a selected air flow direction

Use this function when the air conditioner is operating.

① FIX button

Hold down or briefly press the FIX button on the remote controller to move the louver in the desired direction.

- Change the vertical air flow louver direction within the range indicated.
- In subsequent operations, the vertical air flow is automatically set to the direction that you set the louver using the FIX button.

To automatically swing the air flow direction

Perform this function when the air conditioner is operating.

① SWING button

Press the SWING button on the remote controller.

- To stop the function, press the SWING button.
- To change the swing direction, press the FIX button.

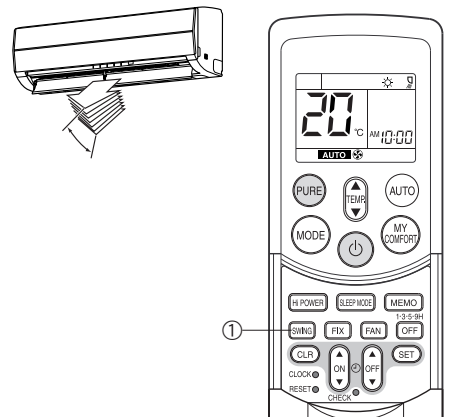
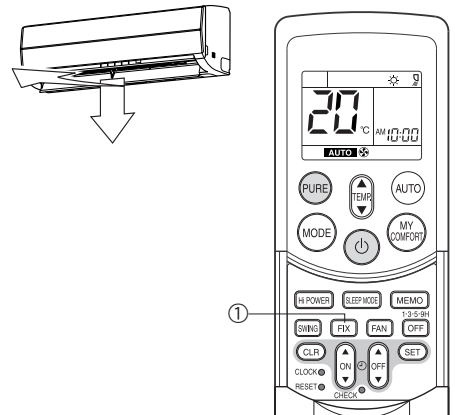

CAUTION

- The FIX and SWING buttons will be disabled when the air conditioner is not operating (including when ON TIMER is set).
- Do not operate the air conditioner for an extended period of time with the air flow direction set downward during the cooling or dry operation. Otherwise, condensation may occur on the surface of the vertical air flow louver and cause water dripping.
- Do not move the vertical air flow louver manually. Always use the FIX button. If you move the louver manually, it may malfunction during operation. If the louver malfunctions, stop the air conditioner once, and restart.
- When the air conditioner is started immediately after it was stopped, the vertical air flow louver might not move for about 10 seconds.

Adjusting the horizontal air flow

Preparation:

- Grasp the lever on the horizontal air flow louver and move them to adjust the air flow direction as required.
- You can adjust the air flow at the left and right locations of the grilles.

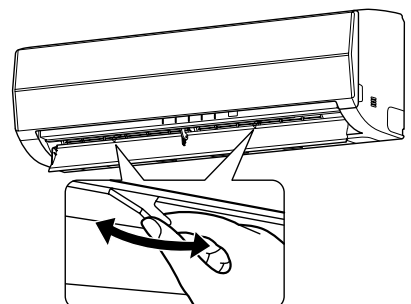
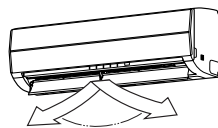

AUTO RESTART OPERATION

This air conditioner is equipped with an automatic restarting function which allows the air conditioner to resume without the use of the remote controller under the operating settings in the event of a power shutdown. Operation resumes without warning 3 minutes after power is restored.

INFORMATION

The AUTO RESTART OPERATION is not set to work at factory shipment, and so it is necessary to set it to this function if required.

HOW TO SET AUTO RESTART

To set the auto restart function, proceed as follows:

The power supply to the unit must be on. The function will not be set if the power is off.

To enable the auto restart function, hold down the RESET button for 3 seconds.

The air conditioner receives the setting and beeps 3 times. The system now restarts automatically. The auto restart setting is activated.

(1) When the air conditioner is in stand-by (not running).

Hold down the RESET button for 3 seconds or more.

- The air conditioner starts to operate. The green indicator turns on.
- After about 3 seconds, the air conditioner beeps 3 times.

The green indicator flashes for 5 seconds.

- The air conditioner is operating.

If the air conditioner is not required to run at this time, push the RESET button again or use the remote controller to stop the air conditioner.

(2) When the air conditioner is operating.

Hold down the RESET button for 3 seconds or more.

- The air conditioner stops operating. The green indicator turns off.
- 3 seconds after pushing the button, the air conditioner beeps 3 times.

The green indicator flashes for 5 seconds

- The air conditioner stops.

If you do not need the air conditioner to stop at this time, use the remote controller to restart the air conditioner. During the subsequent operation, the green indicator is turned on.

- The auto restart operation will not accept a command if timer operation with the remote controller is activated.

- After restarting the air conditioner by the AUTO RESTART OPERATION, the louver swing (AUTO) operation resumes.

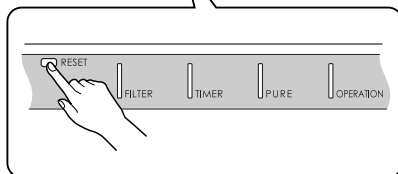
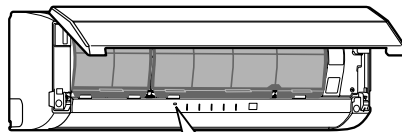

RESET button

HOW TO CANCEL AUTO RESTART

To cancel the auto restart operation, proceed as follows:

Repeat the setting procedure. The air conditioner receives the setting and beeps 3 times.

The air conditioner now needs to be manually restarted with the remote controller after the main supply is turned off.

The auto restart setting is cancelled.

(1) When the air conditioner is in stand-by (not running).

Hold down the RESET button for 3 seconds or more.

- The air conditioner starts to operate.
The green indicator will turn on.
- After about 3 seconds, the air conditioner beeps 3 times.
- The air conditioner is operating.

If the air conditioner is not required to run at this time, push the RESET button again or use remote controller to stop the air conditioner.

(2) When the air conditioner is operating.

Hold down the RESET button for 3 seconds or more.

- The air conditioner stops operating.
The green indicator is turned off.
- After about 3 seconds, the air conditioner beeps 3 times.
- The air conditioner stops.

If you do not need the air conditioner to stop at this time, use the remote controller to restart the air conditioner.

During subsequent operation, the green indicator is turned on.

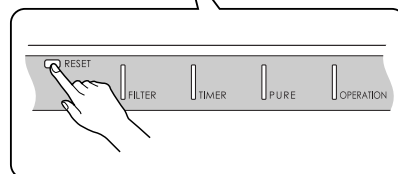
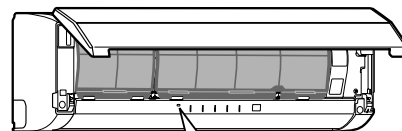

RESET button

HOW THE AIR CONDITIONER WORKS

Automatic Operation

As shown in Figures 1 and 2, Automatic Operation mode selects the operation based on the room temperature data (T_a) when operation begins.

Heat pump models

Room temperature when operation begins or when selected again

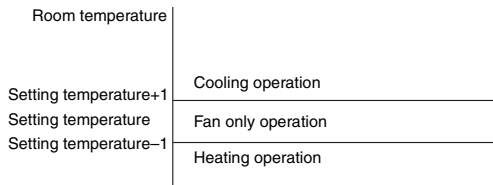

Figure 1

Cooling-only models

Room temperature when operation begins or when selected again

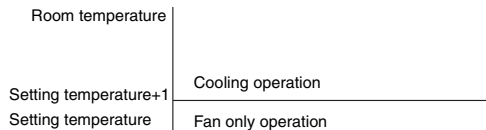

Figure 2

The operation mode is selected again after the compressor has remained stopped for 15 minutes.

Hi POWER operation

When you press the Hi POWER button during cooling, heating or A operation, the air conditioner starts the following operation.

• Cooling operation

The cooling operation is performed at 1°C lower than the temperature setting.

The fan speed is also set to high*.

* The noise level raises, according to the fan speed.

• Heating operation (heat pump models)

The heating operation is performed at 2°C higher than the temperature setting.

The fan speed is automatically switched according to the operating condition.

SLEEP MODE operation

The air conditioner automatically controls the room temperature, air flow and noise level, to prevent overcooling in summer and maintain a warm and comfortable room in winter.

INFORMATION

- The power and noise level are reduced during sleep mode, so the room may not be cooled (or heated: heat pump models only) sufficiently if the mode is used for a long period of time.
- The sleep mode cannot be used during dry operation, PURE operation (independent operation) or fan only operation (cooling-only models only).
(PURE operation (independent operation) is when the PURE button is pressed while the air conditioner is stopped to perform PURE operation by itself. The air conditioner does not operate at this time.)
- If the FAN button is pressed during sleep mode, the sleep mode is canceled.
- Sleep mode is not a timer operation.

Dry operation (Δ)

The dry mode automatically selects the cooling dry operation based on the difference between the temperature setting and the actual room temperature.

The fan speed indicator shows AUTO, and low speed is used.

HINTS FOR ECONOMICAL OPERATION

Maintain room temperature at a comfortable level

Clean the air filters

Clogged air filters impair the performance of the air conditioner. Clean them every two weeks.

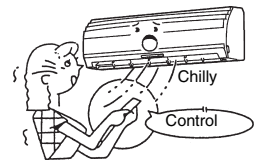
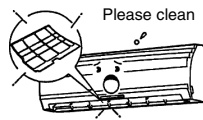

Never open doors and windows more than necessary

To keep cool or warm air in the room, never open doors and windows more than necessary.

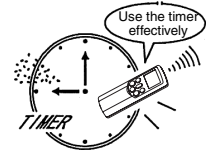
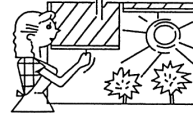

Window curtains

During cooling operation, close the curtains to avoid direct sunlight. During heating operation, close the curtains to keep the heat in.

Use the timer effectively

Set the timer for the desired operating time.

Allow uniform circulation of room air

Adjust the air flow direction for even circulation of room air.

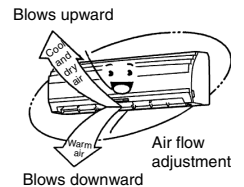
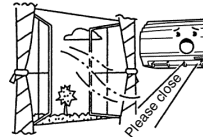

TEMPORARY OPERATION

Temporary operation

This function is used to operate the unit temporarily in case you misplace the remote controller or the batteries are used up.

- Push the RESET button to start the automatic operation (AUTO).
- While the temporary operation is activated, the remote controller operation is disabled.
- Hold down the button for 10 seconds to start the cooling operation.

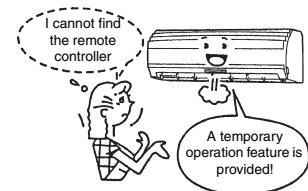

CLEANING OPERATION

Cleaning operation

This function is used to dry the inside of the air conditioner to reduce the growth of mold, etc. inside the air conditioner.

- When the unit shuts down after having operated for 10 or more minutes in the cooling or dry mode, the cleaning operation is started automatically, and the S.CLEAN indicator on the unit's display panel turns on.

Cleaning operation duration

- The cleaning operation lasts for 4 hours if the unit has been operating in the cooling or dry mode for 10 minutes or more.

About the cleaning operation

- The cleaning operation will not make the room cleaner or remove the mold and dust already inside the air conditioner.
- During operation, a small amount of frost may be visible: this is normal and does not indicate a malfunction.
- The vertical airflow louvers open slightly.
- If an ongoing cleaning operation is suspended, the effect of the cleaning will be compromised.
- To forcibly stop the cleaning operation, press the  button twice during the cleaning operation.

USUAL MAINTENANCE

WARNING

Before you clean the air conditioner, be sure to turn off the circuit breaker or main power switch.



Cleaning of indoor unit and remote controller

CAUTION

- Use a dry cloth to wipe the indoor unit and remote controller.
- When the air conditioner is extremely dirty, use a cloth dipped in cold water to wipe the indoor unit.
- Never use a damp cloth on the remote controller.
- Do not use a chemical-based duster for wiping or leave such materials on the unit for extended periods of time. Doing so could damage or cause the surface of the unit to fade.
- Do not use benzene, thinner, polishing powder, or other solvents for cleaning. These can cause the plastic surface to crack or deform.

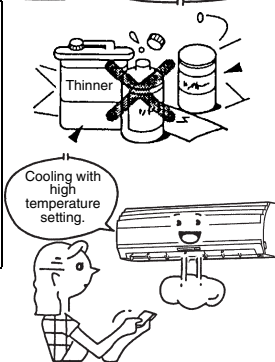

When not using the unit for at least 1 month

- (1) Perform fan operation for 3 to 4 hours to dry the inside of the unit.
 - If a high temperature setting is used with cooling operation, fan operation is performed.
- (2) Stop the air conditioner and turn off the circuit breaker.
- (3) Clean the air filters.
- (4) Remove the batteries from the remote controller.

Check before operation

CAUTION

- Check that the air filters are installed.
- Check that the air outlet and inlet of the outdoor unit are not blocked.

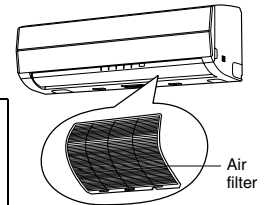

Cleaning the air filter

Clean the air filters every 2 weeks.

The performance of the air conditioner will degrade if the air filters are covered with dust.

Clean the air filters as often as possible.

Preparation:

1. Turn off the air conditioner using the remote controller.
2. Open the air inlet grille.

- 1** Open the air inlet grille.
Lift the air inlet grille up to the horizontal position.
- 2** Grasp the left and right handles of the air filter and lift it up slightly, and then pull it downward to take it out from the filter holder.
- 3** Use a vacuum cleaner to remove the dust from the filters or wash them with water.
After washing the air filters, dry them in the shade.

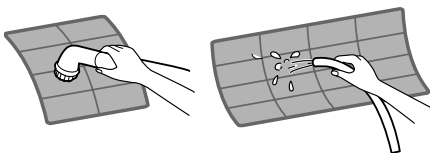
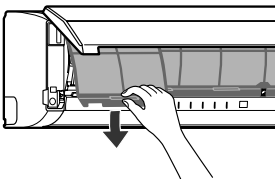
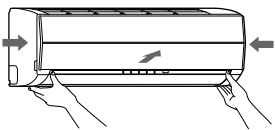

- 4 Insert the top section of the air filter so that its right and left edges fit on the indoor unit and it is firmly set.
- 5 Close the air inlet grille.
 - * If the FILTER indicator on the indoor unit is shown, press the RESET button on the indoor unit to turn off the indicator.

Cleaning the air inlet grille

Preparation:

1. Turn off the air conditioner using the remote controller.
2. Open the air inlet grille.

- 1 Remove the air inlet grille.
Hold the two sides of the air inlet grille and open upwards. Remove the left (or right) arm by pushing it toward the outside and then pulling it toward you.
- 2 Wash it with water using a soft sponge or towel.
(Do not use a metallic scrubbing brush or other hard brushes.)
 - Use of such hard objects will cause scratches on the surface of the grille and the metal coating to peel off.
 - If extremely dirty, clean the air inlet grille with a neutral kitchen detergent and rinse it off with water.
- 3 Wipe off the water from the air inlet grille and dry it.
- 4 Fit the left and right arms of the air inlet grille to the shafts on the two sides of the air conditioner and push them in completely.
- 5 Pull the air inlet grille downward.
 - Push the arrow locations (four) at the bottom of the air inlet grille to check that the grille is completely closed.

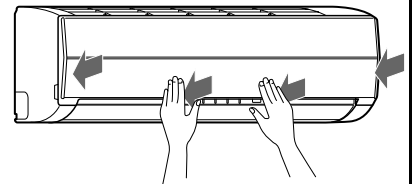
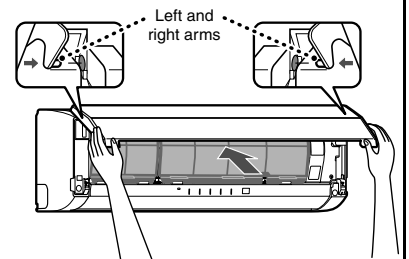
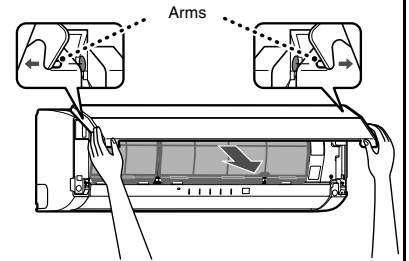
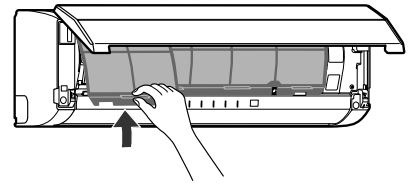

NOTE

Cleaning and maintenance of the indoor/outdoor units are strongly recommended for air conditioning systems which are used regularly. Failure to clean the indoor/outdoor units regularly will result in poor cooling performance, icing, water leakage and even premature compressor failure.

SPECIAL MAINTENANCE

Cleaning the plasma pure filter

Preparation:

1. Turn off the air conditioner using the remote controller.
2. Turn off the power supply.

- Clean the plasma pure filter when the FILTER indicator (orange) turns on. (This indicator turns on after PURE operation of about 1000 hours.)
- After cleaning is finished, push the RESET button on the indoor unit.
- Perform cleaning every six months or so.
- Even if the FILTER indicator does not turn on, clean the plasma pure filter whenever the unit makes a humming, clicking, or buzzing sound. If the indicator turns on during the night, the air conditioner can still be used until the morning without a problem, but be sure to perform cleaning as soon as possible.

- 1** Open the air inlet grille.
Lift up the air inlet grille until it clicks into place.
- 2** Grasp the left and right handles of the air filter and lift up slightly and then pull downward to remove the filter from the filter holder.
- 3** Take out the plasma pure filter.
 - Grasp the handles, and then pull out as shown in ① and ②.

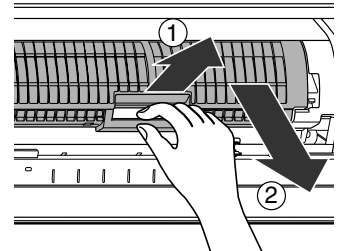

Checks after cleaning the plasma pure filter

1. Confirm the FILTER indicator does not turn on by activating PURE operation for one hour or more.
<If it does not turn on, it is normal>
2. If the FILTER indicator turns on, recheck the following.
 - a) Fitting of the plasma pure filter
 - b) Fitting of the air inlet grilleAnd, reconfirm the FILTER indicator does not turn on by activating PURE operation for another one hour or more.
<If it does not turn on, it is normal>
3. In case the FILTER indicator does turn on, please call a service representative.

- 4** Wash and then dry.
- (1) Soak in hot water at 40 to 50°C for about 10 to 15 minutes. If the staining is particularly severe, use a washing detergent compound (weak basic or neutral) at 10 to 15 times the standard concentration.
 - (2) Rub up and down, and rub left and right. Also, rub the surface gently with a sponge.
 - (3) Rinse with running water.
 - (4) Shake thoroughly, and allow the unit to drain.
(If oil or smoke strains are particularly hard to remove, repeat steps (1) to (4) 2 or 3 times.)
 - (5) Dry thoroughly in the shade.

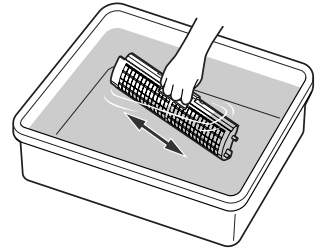

CAUTION

- Never use any products marked as “bleach”.
- Do not attempt to disassemble the unit.
- Do not rub with a scrubbing brush or similar implement.
- Do not utilize washing devices or equipment.
- Do not dry with a hair dryer or other appliance that uses hot air. (The heat can cause the unit to deform.)
- After cleaning, wait until the unit is completely dried before attaching. The FILTER indicator may turn on if the unit is used while wet.

- 5** Attach the plasma pure filter.
- Grasp the handles, and then insert as shown in ①. Insert into the right and left guide rails, and then press in the direction of ② after it is all the way in.
 - Press both ends of the plasma pure filter in the direction of ③ until the protrusions on both sides of the plasma pure filter are completely inserted into the holders.

Press in the plasma pure filter until the protrusions on both sides are completely inserted into the holders. If installation is incomplete, the FILTER indicator (orange) may light.

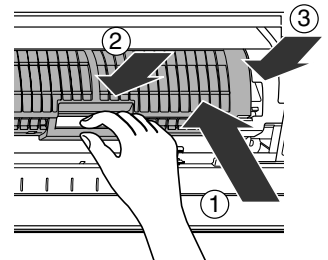

- 6** Attach the air filter, and then close the air inlet grille.

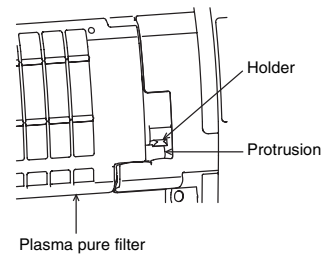

AIR CONDITIONER OPERATION AND PERFORMANCE

Three-minute protection feature

A protection feature is provided that prevents the air conditioner from being activated for approximately 3 minutes when it is restarted immediately after operation or when the power supply switch is set to on. This is used to protect the machine.

Heating characteristics (heat pump models)

Preheating operation

The air conditioner does not deliver warm air immediately after it is started.

Warm air flows out after approximately 5 minutes when the indoor heat exchanger has warmed up.

Warm air control

When the room temperature reaches the temperature setting, the fan indoor speed is automatically reduced.

The outdoor unit is stopped at this time.

Defrosting

If frost has formed on the outdoor unit during the heating operation, defrosting is started automatically (for approximately 5 to 10 minutes) to maintain the heating effect.

- The fans in both the indoor and outdoor units stop during the defrost operation.
- During the defrost operation, defrosted water is drained from the bottom plate of the outdoor unit.

Heating capacity



In the heating operation, heat is absorbed from outdoors and released into the room. That is called the heat pump system. When the outdoor temperature is too low, usage of another heating apparatus in combination with the air conditioner is recommended.

Consideration for accumulated snow

Select the position for the outdoor unit where it will not be subjected to snow drifts, accumulation of leaves or other seasonal debris. It is important that the air flow of the outdoor unit is not blocked as this will result in reduced heating or cooling performance. During the heating mode and at sub-zero temperatures, the water drained off the outdoor unit as a result of the automatic defrost may accumulate and freeze. It is important that adequate drainage or a soak-way be provided.

Power failure

Power failure during operation stops the unit completely.

- The OPERATION indicator (green) on the indoor unit starts flashing when power is restored.
- To restart operation, push the  button on the remote controller.
- Lightning or a car wireless telephone operating nearby may cause the unit to malfunction. Turn the power supply switch off and then on again. Push the  button on the remote controller to restart.

Air conditioner operating conditions

For proper performance, operate the air conditioner under the following temperature conditions.

Cooling operation	Outdoor temperature: -10°C to 46°C
	Room temperature: 21°C to 32°C
	CAUTION Room relative humidity — less than 80%. If the air conditioner operates outside this range, the surface of the air conditioner may attract condensation.
Heating operation (heat pump models)	Outdoor temperature: -15°C to 24°C
	Room temperature: Less than 28°C
Dry operation	Outdoor temperature: -10°C to 46°C
	Room temperature: 17°C to 32°C

If the air conditioner is used in conditions other than above, the safety protection functions may be activated.

When the indoor unit is connected to the inverter multi outdoor unit, you may feel a heating effect in heater mode even if it is set to thermo off.

For details on the specifications when used in combination with a multi air conditioner outdoor unit, refer to the specifications table provided with the multi air conditioner outdoor unit.

TROUBLESHOOTING

CAUTION

If any of the following conditions occur, stop the air conditioner immediately, turn off the main power switch and contact the dealer.

- The indicators flash at short intervals (5 Hz). Reset the circuit breaker 2 to 3 minutes after the power main switch is turned off. Despite the resetting operation, the indicators still continue turning on and off.
- The main power fuse often blows, or the circuit breaker is often activated.
- Foreign matter or water has fallen inside the air conditioner.
- Any other unusual conditions are observed.

Before asking for servicing or repairs, check the following points.

Inoperative

- The power main switch is turned off.
- The circuit breaker is activated to cut off the power supply.
- The main power fuse has blown.
- The electric current has stopped.
- The batteries in the remote controller used up.
- The ON timer is set.
- As a protective mechanism for the air conditioner, it does not operate for 3 minutes immediately after restarting operation or turning on the main power.



Poor cooling or heating performance

- The air inlet or outlet of the outdoor unit is blocked.
- Doors or windows are opened.
- The air filter is clogged with dust.
- The louver is not at the correct position.
- The fan speed is set to low.
- The air conditioner is set to the DRY or SLEEP MODE.
- The temperature setting is too high (during cooling operation).
- The temperature setting is too low (during heating operation). (heat pump models)



Recheck

Before asking for servicing or repairs, check the following points.

Condensation forms on the back of the indoor unit.

- Condensation on the back of the indoor unit is automatically collected and drained out.

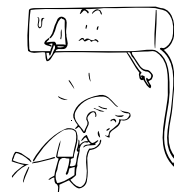

Indoor unit or outdoor unit makes a strange noise.

- When the temperature changes sharply, the indoor or outdoor unit may make a strange noise (such as a tit-tack noise or flowing noise) because of the expansion/contraction of parts or change in refrigerant flow.

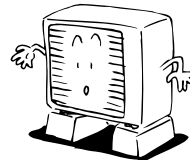

The room air smells.

A bad odor comes from the air conditioner.

- Smells absorbed in the wall, carpet, furniture, clothing, or furs are coming out.
- During PURE operation, a small amount of ozone is produced, and you might notice the smell.

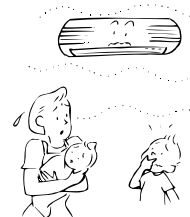

The OPERATION indicator turns on and off.

- The indicator turns on and off (1 Hz) when power is restored after a power failure or when the power main switch is set to on. Reset the circuit breaker to ON.

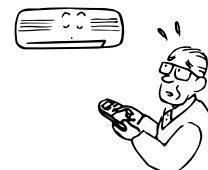

Frost forms on the outdoor unit during heating operation. (heat pump models)

Water is drained from the outdoor unit.

- Frost sometimes forms on the outdoor unit during heating operation. In that case, the unit automatically performs defrosting (for 2 to 10 minutes) for improving the heating efficiency.
- In the defrosting operation, the airflow from both the indoor and outdoor units stops.
- A hiss sound is heard when the flow of the refrigerant is changed for defrosting.
- The water resulting from automatic defrosting during the heating operation is drained from the outdoor unit.

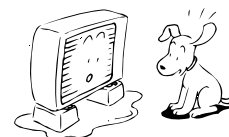

The air flow changes even though the FAN button is not set to the AUTO mode.

- When the temperature of the blown air goes down during heating operation, the air conditioner automatically changes or stops the air flow from the indoor unit so that the people in the room do not feel chilly.

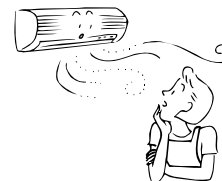

A white mist of chilled air or water is generated from the outdoor unit.

- Steam is sometimes generated from the indoor unit during cooling operation or the outdoor unit during defrosting operation.



Automatic operation of vertical air flow louvers (heat pump models)

- When the room temperature or outdoor temperature is high during the heating operation, the vertical air flow louvers close once and then set themselves automatically to the original position setting again.



These are not defects.

Before asking for servicing or repairs, check the following points.

The FILTER indicator turns on.

- This indicator turns on after PURE operation has been performed for approximately 1000 hours.
- The indicator may turn on if the front panel is not firmly closed.
- The indicator may turn on if the plasma pure filter is not securely attached.

Sounds made from the indoor unit

- The plasma pure filter may make a humming, clicking, or buzzing sound when it is dirty.
- When the power is turned on or the air conditioner is stopped, the vertical air louvers may make a rattling sound or shuttling sound.
- Some parts may expand or shrink due to temperature fluctuations, and this can result in a slapping sound.
- When the refrigerant is flowing, a hissing sound or gurgling sound can result.
- A hissing sound can be made when the air conditioner is switched to defrosting operation during heating operation.

Sounds made from the outdoor unit (heat pump models)

- A rustling sound can be made when the air conditioner is switched to defrosting operation during heating operation.

COOL, DRY, or HEAT operation cannot be performed. (For multi outdoor unit connection)

- When the unit in other room operates previously in different mode, FAN ONLY operation is performed because of first-push priority control. (COOL operation and DRY operation can be concurrently performed.)

These are not defects.

SPECIFICATIONS

Type			Reverse cycle, Split type			
Model			Indoor Unit		Outdoor Unit	
			RAS-B10SKVP-E		RAS-10SAVP-E	
Power supply			220–240 V ~50 Hz 220 V ~60 Hz		220–240 V ~50 Hz 220 V ~60 Hz	
Cooling capacity	(kW)	CAPA.	2.5		3.5	
Heating capacity	(kW)	CAPA.	3.2		4.2	
Cooling current	(A)	AMP.	0.15	2.57–2.34	0.15	4.00–3.66
Cooling power	(W)	WATT.	30	460	30	820
Heating current	(A)	AMP.	0.15	3.15–2.87	0.15	4.40–4.02
Heating power	(W)	WATT.	30	600	30	920
Dimensions	Width (mm)		790	780	790	780
	Height (mm)		250	550	250	550
	Depth (mm)		208	290	208	290
Net weight	(kg)		9	38	9	38

Type			Reverse cycle, Split type			
Model			Indoor Unit		Outdoor Unit	
			RAS-B16SKVP-E		RAS-16SAVP-E	
Power supply			220–240 V ~50 Hz 220 V ~60 Hz			
Cooling capacity	(kW)	CAPA.	4.5			
Heating capacity	(kW)	CAPA.	5.5			
Cooling current	(A)	AMP.	0.15		6.18–5.65	
Cooling power	(W)	WATT.	30		1,320	
Heating current	(A)	AMP.	0.15		6.83–6.25	
Heating power	(W)	WATT.	30		1,460	
Dimensions	Width (mm)		790		780	
	Height (mm)		250		550	
	Depth (mm)		208		290	
Net weight	(kg)		9		38	

- These specifications are subject to change without notice for the purpose of incorporating technical improvements.

The specified air-conditioning performance is based on the data determined under the following conditions.

For cooling

Air inlet temperature °C			
Indoor coil assembly		Outdoor coil assembly	
Dry bulb	Wet bulb	Dry bulb	Wet bulb
27	19	35	24





For heating (heat pump models)

Air inlet temperature °C			
Indoor coil assembly		Outdoor coil assembly	
Dry bulb	Wet bulb	Dry bulb	Wet bulb
20	—	7	6



For details on the specifications when used in combination with a multi air conditioner outdoor unit, refer to the specifications table provided with the multi air conditioner outdoor unit.

TROUBLESHOOTING (Remote Controller)

Before asking for servicing or repairs, check the following points.

The remote controller does not operate correctly.		
Symptoms	Causes	Possible Solution
The operating mode switches.	<ul style="list-style-type: none"> Check whether the MODE indicated on the display is AUTO. <p style="text-align: center;">AUTO</p>	The fan speed and louver direction cannot be changed in AUTO mode. When the SWING, FIX or FAN buttons are pressed in AUTO mode, the mode changes to A mode.
The fan speed cannot be changed.	<ul style="list-style-type: none"> Check whether the MODE indicated on the display is  DRY. <p style="text-align: center;"> : DRY</p>	When dry operation is selected, the air conditioner automatically selects the fan speed. The fan speed can be selected during  COOL,  HEAT, A and  FAN ONLY.

The Display Goes Off		
Symptoms	Causes	Description
The indicators on the display are not shown after a short time.	<ul style="list-style-type: none"> Check whether the timer operation is over when the OFF TIMER is shown on the display. 	The air conditioner stops since the setting time has elapsed.
The TIMER display turns off after a certain period of time.	<ul style="list-style-type: none"> Check whether the timer operation has started when the ON TIMER is shown on the display. <p style="text-align: center;"> : ON</p>	When the time reaches the time setting for the ON timer operation, the air conditioner starts to operate automatically and the ON timer display turns off.

The Signal Receiving Tone Does Not Sound		
Symptoms	Causes	Description
No receiving tone is made from the indoor unit even when the  button is pushed.	<ul style="list-style-type: none"> Check whether the infrared signal transmitter of the remote controller is properly pointed towards the receiver of the indoor unit when the  button is pushed. 	Point the infrared signal transmitter of the remote controller towards the receiver of the indoor unit, and then press the  button repeatedly.

Information according to EMC Directive 2004/108/EC	
(Name of the manufacturer)	TOSHIBA CARRIER CORPORATION
(Address, city, country)	336 Tadehara, Fuji-shi, Shizuoka-ken, 416-8521 Japan
(Name of the Importer / Distributor in EU)	Toshiba Carrier UK Ltd.
(Address, city, country)	Porsham Close, Belliver Industrial Estate, PLYMOUTH, Devon, PL6 7DB. United Kingdom

TOSHIBA CARRIER CORPORATION