



UTY-DCGY
UTY-DCGG

OPERATING MANUAL

CENTRAL REMOTE CONTROLLER
KEEP THIS MANUAL FOR FUTURE REFERENCE

English

使用说明书

中央控制器
使用产品前请仔细阅读本使用说明书
请保留本说明书以供今后参考

中文

MODE D'EMPLOI

TÉLÉCOMMANDE CENTRALE

Français

MANUAL DE FUNCIONAMIENTO

CONTROLADOR REMOTO CENTRAL

Español

MANUAL DE INSTRUÇÕES

CONTROLE REMOTO CENTRAL

Português

BEDIENUNGSANLEITUNG

ZENTRALE FERNBEDIENUNG

Deutsch

MANUALE DI ISTRUZIONI

TELECOMANDO CENTRALE

Italiano

ΕΓΧΕΙΡΙΔΙΟ ΛΕΙΤΟΥΡΓΙΑΣ

ΚΕΝΤΡΙΚΟ ΤΗΛΕΧΕΙΡΙΣΤΗΡΙΟ

Ελληνικά

РУКОВОДСТВО ПО ЭКСПЛУАТАЦИИ

ЦЕНТРАЛЬНЫЙ ДИСТАНЦИОННЫЙ КОНТРОЛЛЕР

Русский

MANUEL ÇALIŞMA

MERKEZİ UZAKTAN KUMANDA

Türkçe

دليل التشغيل

وحدة التحكم عن بعد المركزية

عربي

FUJITSU GENERAL LIMITED
富士通将军有限公司

[Original instructions]
PART NO. 9378379046-04

Contents

INTRODUCTION

■ SAFETY PRECAUTIONS

■ SYSTEM OUTLINE

- 1 Terminology..... 3
- 2 Control unit..... 5
- 3 Password configuration..... 6
- 4 Description of LCD display and buttons..... 6

INITIALIZATION

■ INITIALIZATION PROCEDURE 7

1 MONITOR

■ 1-1 Monitor

- 1-1-1 Monitor Mode display – Main screen 8
- 1-1-2 Operation status details display 10

2 CONTROL

■ 2-1 Control

- 2-1-1 Operation Setting display 12

3 SETTING

■ 3-1 Setup Menu

- 3-1-1 Shifting to Setup Menu..... 14

■ 3-2 Installer Setting

- 3-2-1 Installer Setting screen..... 16
- 3-2-2 Central Controller Address Setting..... 16
- 3-2-3 Language Setting..... 17
- 3-2-4 Indoor Unit Setting 17
- 3-2-5 Temperature Unit Setting 21
- 3-2-6 Management Setting..... 22
- 3-2-7 External Input Setting..... 22
- 3-2-8 Set Temp. Range Setting 23
- 3-2-9 Change Password (For installer)..... 23

■ 3-3 System Setting

- 3-3-1 System Setting screen 24
- 3-3-2 Date Setting 24
- 3-3-3 Group Setting..... 26
- 3-3-4 Schedule Setting..... 29
- 3-3-5 Password Setting (For manager) 34

■ 3-4 Preference Setting

- 3-4-1 Preference Setting screen..... 36
- 3-4-2 Backlight Setting 36
- 3-4-3 Display Setting 37
- 3-4-4 Sound Setting..... 37

■ 3-5 Maintenance Setting

- 3-5-1 Maintenance Setting screen..... 37
- 3-5-2 Error History 38
- 3-5-3 Version information 38
- 3-5-4 Setting Status List 38

■ 3-6 Indoor Unit Special Setting

- 3-6-1 Indoor Unit Special Setting screen..... 39
- 3-6-2 Test Operation setting 39
- 3-6-3 Filter Sign reset..... 40
- 3-6-4 Indoor Unit Set Temp. Range Setting..... 41
- 3-6-5 R.C. Prohibition Setting..... 42

■ 3-7 Outdoor Unit Special Setting

- 3-7-1 Outdoor Unit Special Setting screen..... 44
- 3-7-2 Low Noise Operation..... 44
- 3-7-3 Capacity Control Setting 47

4 OTHERS

■ 4-1 Outline dimensions 49

■ 4-2 Specifications 50

■ 4-3 Error code 50

INTRODUCTION

■ SAFETY PRECAUTIONS

- The "SAFETY PRECAUTIONS" indicated in the manual contain important information pertaining to your safety. Be sure to observe them.
- For details of the operation methods, refer to the manual.
- Request the user to keep the manual on hand for future use, such as for relocating or repairing the unit.

 WARNING	<p>This mark indicates procedures which, if improperly performed, might lead to the death or serious injury of the user.</p>
<ul style="list-style-type: none"> • In the event of a malfunction (burning smell, etc.), immediately stop operation, turn off the electrical breaker, and consult authorized service personnel. 	
<ul style="list-style-type: none"> • Do not repair or modify any damaged cable by yourself. Let the authorized service personnel do it. Improper work will cause an electric shock or a fire. 	
<ul style="list-style-type: none"> • When moving, consult authorized service personnel for uninstallation and installation of this unit. 	
<ul style="list-style-type: none"> • Do not touch with wet hands. It may cause an electric shock. 	
<ul style="list-style-type: none"> • If children may approach the unit, take preventive measures so that they cannot reach the unit. 	
<ul style="list-style-type: none"> • Do not repair or modify by yourself. It may cause a fault or accident. 	
<ul style="list-style-type: none"> • Do not use flammable gases near the unit. It may cause a fire from leaking gas. 	

 CAUTION	<p>This mark indicates procedures which, if improperly performed, might possibly result in personal harm to the user or damage to property.</p>
<ul style="list-style-type: none"> • Do not set vessels containing a liquid on this unit. Doing so will cause heating, fire or electric shock. 	
<ul style="list-style-type: none"> • Do not expose this unit directly to water. Doing so will cause trouble, electric shock or heating. 	
<ul style="list-style-type: none"> • Dispose of the packing materials safely. Tear and dispose of the plastic packing bags so that children cannot play with them. There is the danger of suffocation if children play with the original plastic bags. 	
<ul style="list-style-type: none"> • Do not place electrical devices within 1 meter of this unit. It may cause malfunction or failure. 	
<ul style="list-style-type: none"> • Do not use fire near this unit or place a heating apparatus nearby. It may cause malfunction. 	
<ul style="list-style-type: none"> • Do not touch the switches with sharp objects. Doing so will cause injury, trouble, or electric shock. 	
<ul style="list-style-type: none"> • This appliance is not intended for use by persons (including children) with reduced physical, sensory or mental capabilities, or lack of experience and knowledge, unless they have been given supervision or instruction concerning use of the appliance by a person responsible for their safety. Children should be supervised to ensure that they do not play with the appliance. 	

SYSTEM OUTLINE

1 Terminology

• Controller related terms

This central remote controller is used for VRF V-II series or J-II series network system.

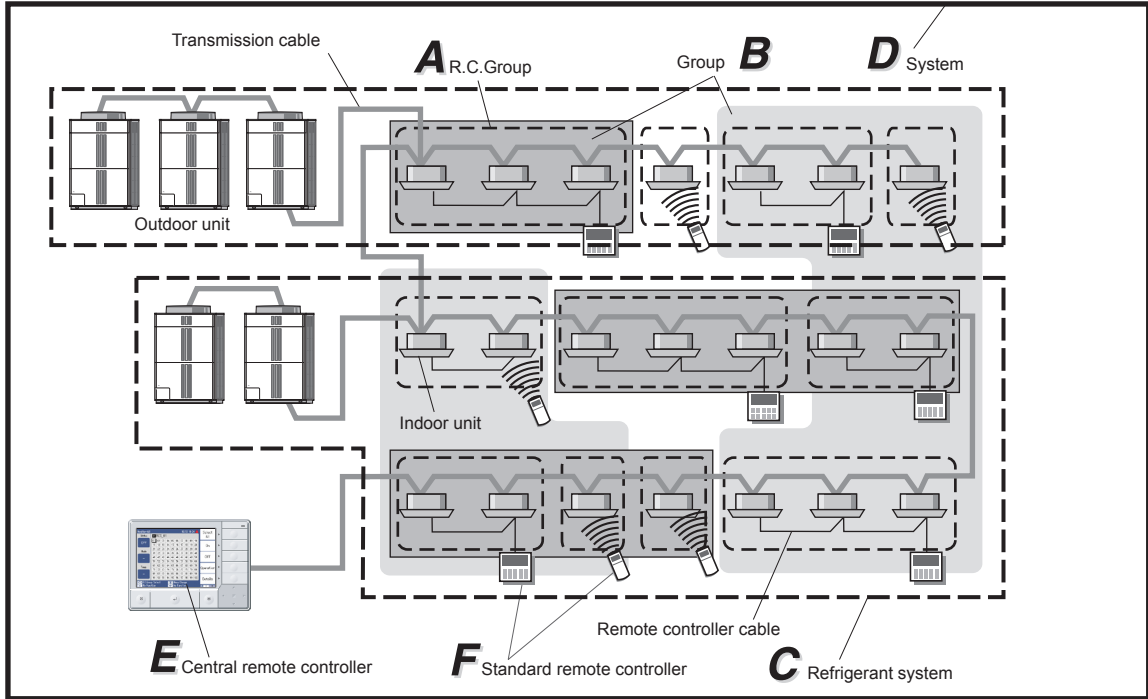

A R.C. Group:
This is the group of indoor units that have been connected with remote controller cable, or single indoor unit.

B Group:
Aggregate for collectively controlling 1 or multiple R.C Groups.

C Refrigerant system:
This is a system that is composed of indoor units, outdoor unit as well as those of relevant control equipment. All of the units and the equipment are connected with pipes with the same refrigerant.

D System:
This is all of the indoor units, outdoor unit as well as those of relevant control equipment (Central remote controller, standard remote controllers) that are connected with the same transmission cable.

E Central remote controller:
The Central remote controller is a remote controller that allows centralized control of multiple indoor units. A Central remote controller can control the operation of the indoor units and timers in 3 units: All, Group and Individual. Moreover, 1 Central remote controller can control up to 100 indoor units and 16 groups.

F Standard remote controller:
The standard remote controller is a remote controller that controls indoor units that have been formed into R.C. Groups. There are 4 kinds of standard remote controllers: wired remote controller, wireless remote controller, simple remote controller and external switch controller.

• Address related terms

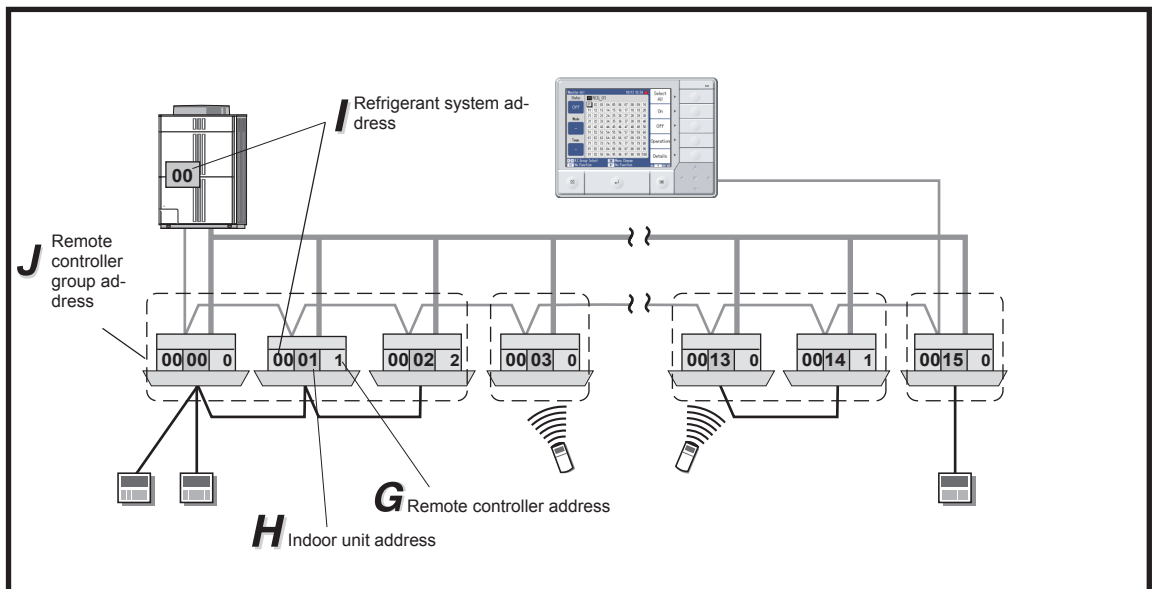

G Remote controller address (0-15):
This is the ID individually assigned to the indoor units forming each R.C. Group and is used for control.

H Indoor unit address (00 - 63):
This is the ID individually assigned to each indoor unit and is used for control.

I Refrigerant system address (0 - 99):
This is the ID individually assigned to each refrigerant system and is used for control.

J Remote controller group address:
The Remote controller group address (R.C. Group Address) is made up of remote controller address "0", refrigerant system address, and indoor unit address.

2 Control unit

The units which can be controlled by Central remote controller have the composition shown in the figure below.

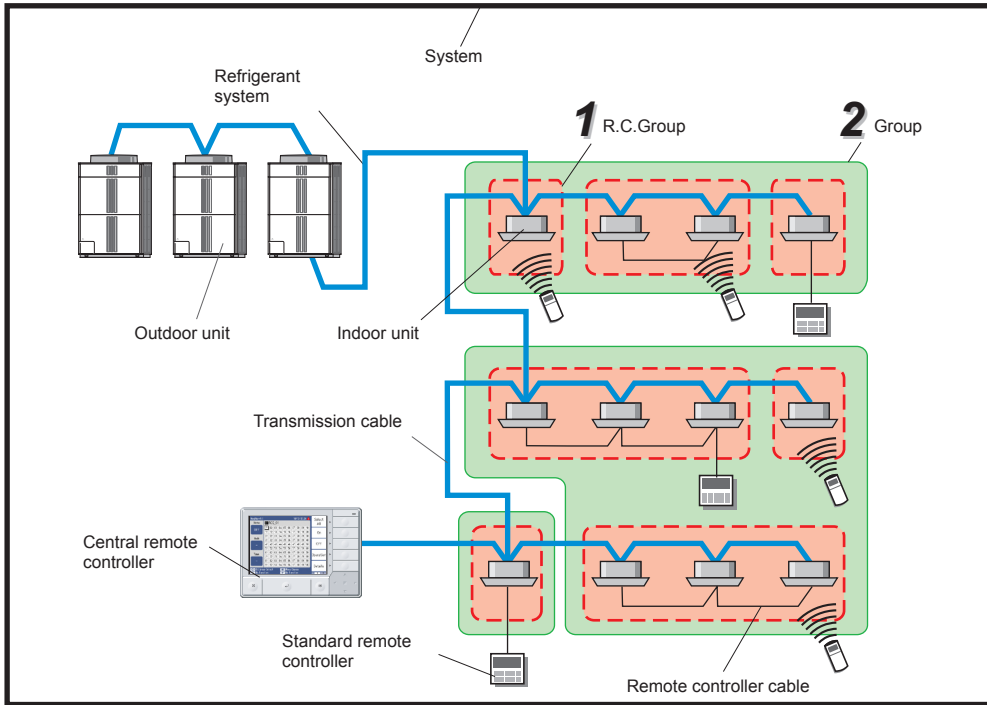

1	R.C.Group	Group of indoor units connected by remote controller cable of standard remote controller. This group operates under the same conditions based on commands from the standard remote controller.
2	Group	Group consists of an R.C. Group of 1 or more units. Each group can be controlled by a central remote controller.

3 Password configuration

The kinds and relationship of passwords which can be set at this controller are as follows:

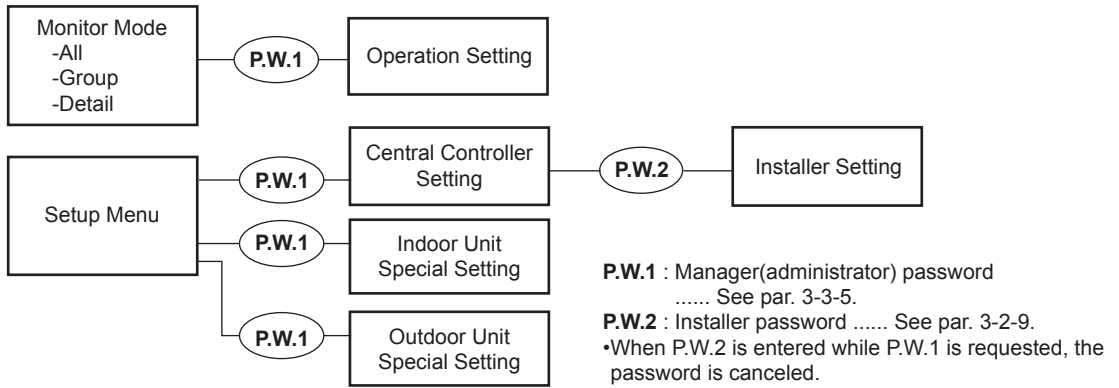

4 Description of LCD display and buttons

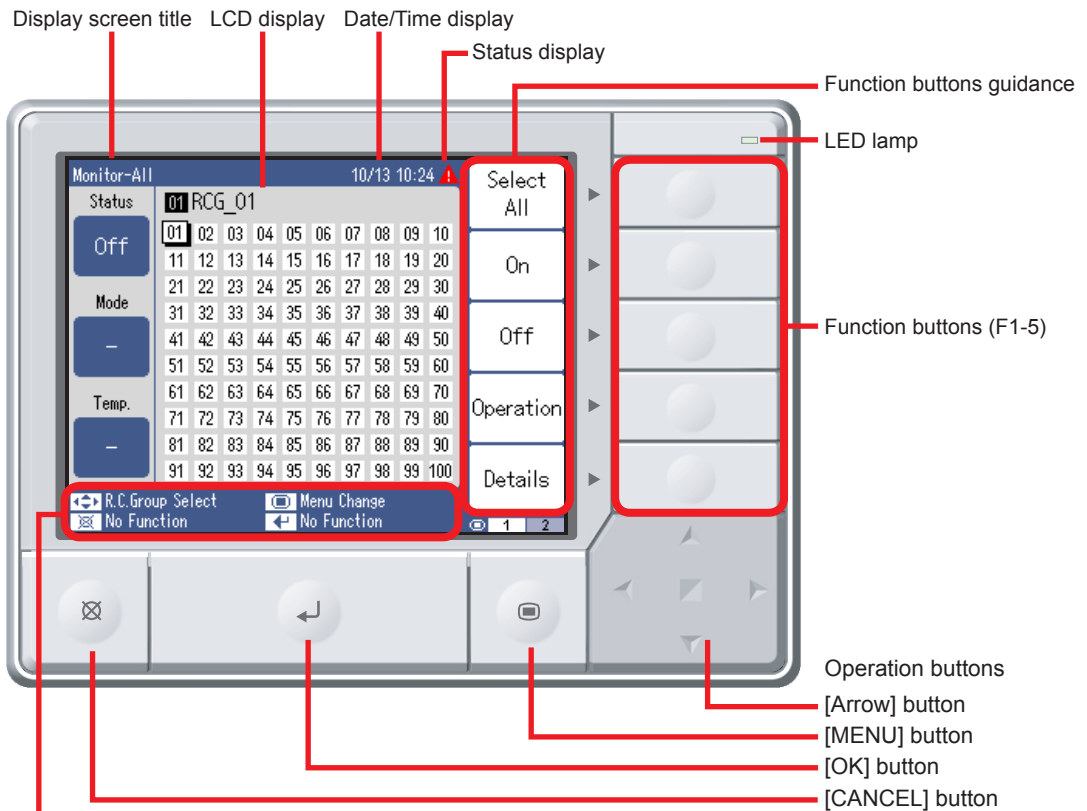

Operation buttons guidance

In this operating manual, operation buttons are described by using illustrations like that shown below.

[Arrow] button	[↔] button
[MENU] button	[☰] button
[OK] button	[↵] button
[CANCEL] button	[⊗] button

INITIALIZATION

INITIALIZATION PROCEDURE

After Central remote controller installation work is complete, perform initialization using the following procedures before starting to use the system.

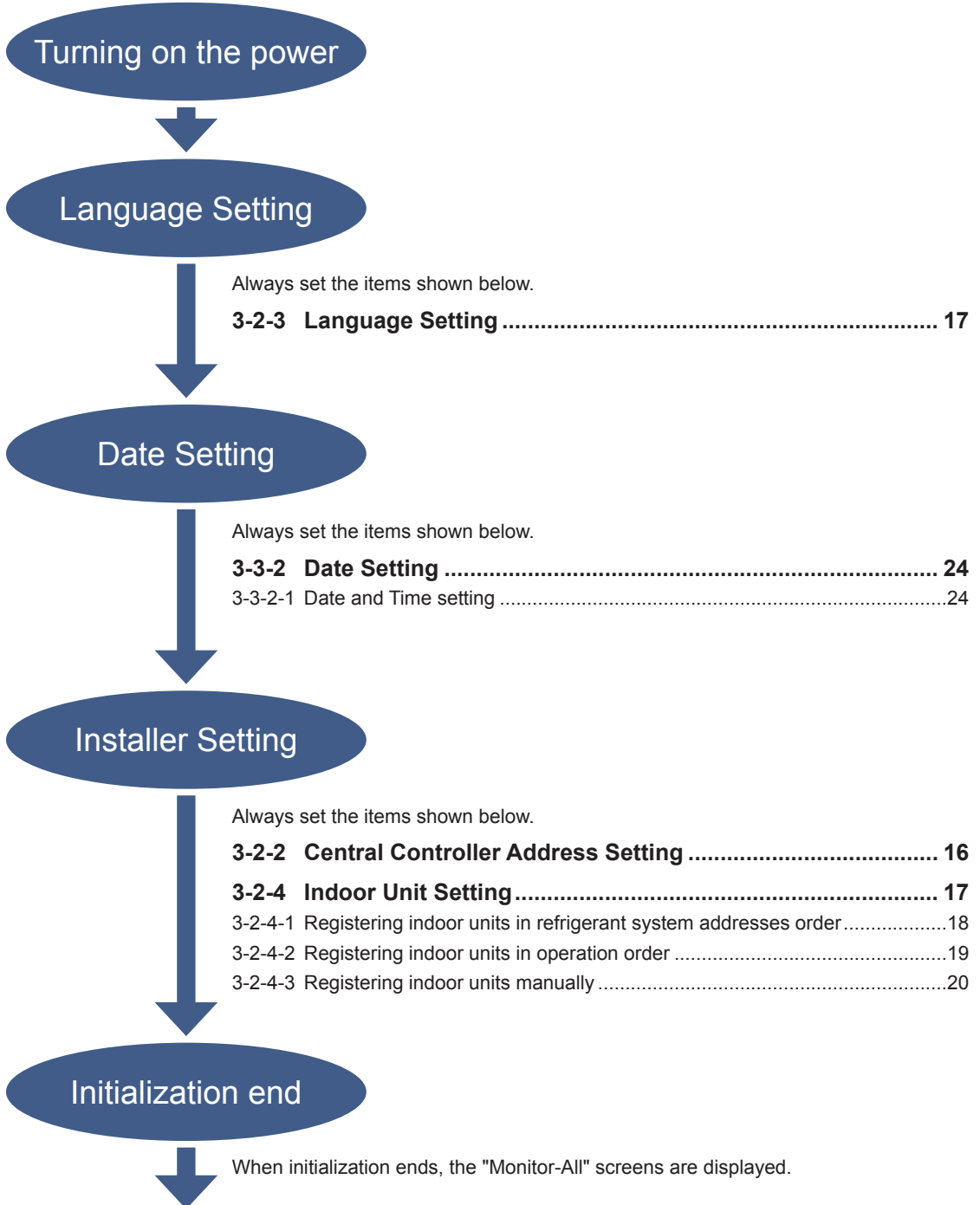

Operation start preparations complete

1 MONITOR

1-1 Monitor

1-1-1 Monitor Mode display – Main screen

The Monitor mode consists of the 2 modes “Monitor-All” and “Monitor-Group”.

- In the “Monitor-All” mode, operation status confirmation and operation are possible in registered “R.C. Group” units.
- In the “Monitor-Group” mode, operation status confirmation and operation are possible in registered “Group” units.

(1) The main screen display is automatically switched in 5 steps according to the number of connected indoor units.

	1	2	3	4	5
Number of connected units (units : R.C.Group)	1 to 9 units	10 to 20 units	21 to 40 units	41 to 80 units	81 to 100 units
Display patterns	9 units display	20 units display	40 units display	80 units display	100 units display

9 units display / 20 units display

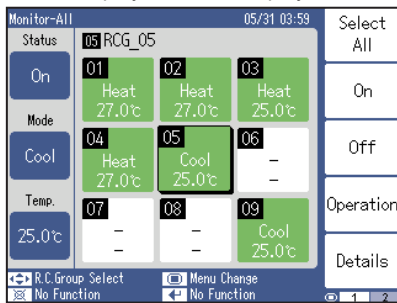

40 units display / 80 units display / 100 units display

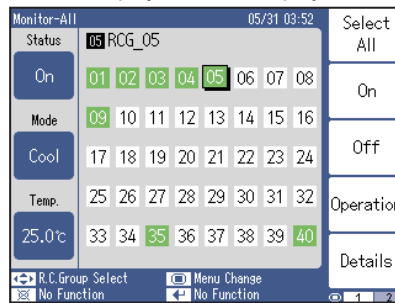

In the Monitor mode, the followings are possible:

(2) The indoor unit (R.C. Group) operation status can be checked.

“Monitor-All” mode

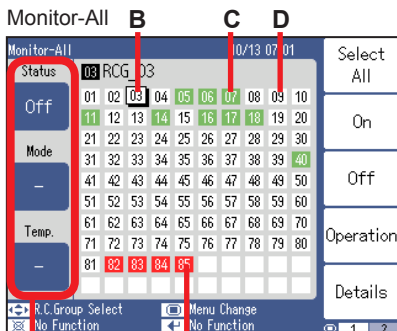

A
Press the [Monitor All (F1)] button after pressing the [] button.

E
Press the [Monitor Group (F1)] button after pressing the [] button.

A: Displays the operation status (“Status”, “Mode”, and “Temp”) of the indoor unit (R.C. Group) selected with the [] button.

B: (Black frame): State in which the indoor unit (R.C. Group) is selected.

- The name of the registered indoor unit (R.C. Group) is displayed.
- When the [] button is pressed, the selected indoor unit (R.C. Group) changes.

C-E: Displays the indoor unit (R.C. Group) operation status.

C: (Green): Indoor unit (R.C. Group) is operating.

D: (White): Indoor unit (R.C. Group) is stopped.

E: (Red): Emergency stop or Error is generated.

Note

When you want to see details of the operation status, press the [Details (F5)] button.

→For details, see “1-1-2 Operation status details display”.

“Monitor-Group” mode
 (“Group Select” screen)

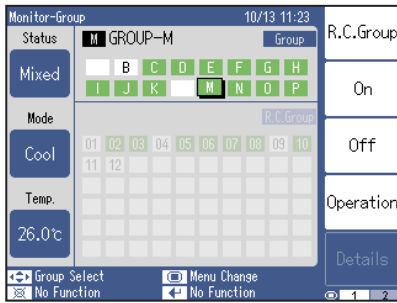

- On the “Group Select” screen, the operation status of the indoor unit (R.C. Group) is displayed in Group units.
- When “Mixed” is displayed as the operation status, the setting among “R.C. Group” is not matched.

■ On the “Monitor-Group” screen, “Group” name is displayed at the top.

The “R.C. Group” name registered at “Group” is displayed at the lower side. Operation in “Group” units or “R.C. Group” units is possible.

(3) On/Off operation can be performed.

“Monitor-All” mode

Monitor-All

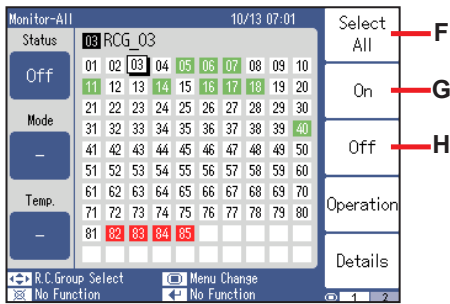

Press the [Monitor All (F1)] button after pressing the [] button.



Press the [Monitor Group (F1)] button after pressing the [] button.

[R.C. Group (F1)] button



[Group (F1)] button

“Monitor-Group” mode
 (“R.C. Group Select” screen)

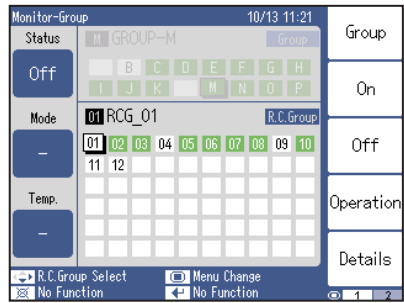

- On the “R.C. Group” screen, the operation status of the indoor unit (R.C. Group) is displayed in “R.C. Group” units.

F: All the indoor unit (R.C. Group) are batched and selected.

G: The selected indoor unit (R.C. Group) is operated.

Example of operating a selected indoor unit (R.C. Group)

- Press the [] button and move the cursor to the indoor unit (R.C. Group). When the [ON (F2)] button is pressed, operation starts.

H: Selected indoor unit (R.C. Group) is stopped.

Note

When you want to perform detailed setting, press the [Operation (F4)] button.

→For details, see “2 CONTROL”.

“Monitor-Group” mode
 (“Group Select” screen)

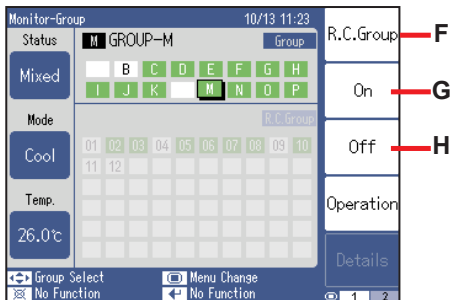

[R.C. Group (F1)] button



[Group (F1)] button

“Monitor-Group” mode
 (“R.C. Group Select” screen)

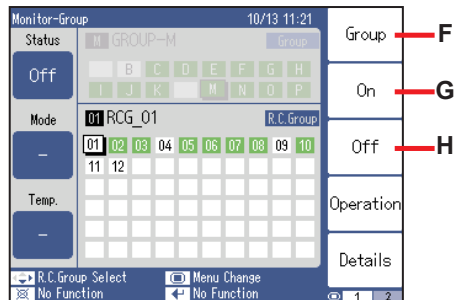

1-1-2 Operation status details display

“Monitor-All” mode

Monitor-All

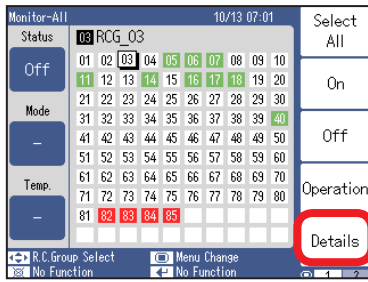

“Monitor-Group” mode

(R.C. Group Select screen)

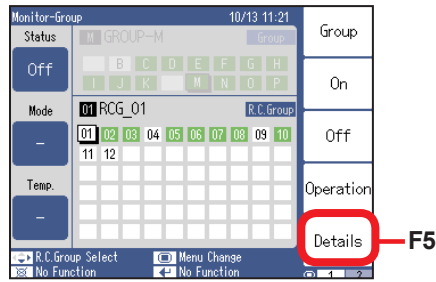

[Details(F5)]
button

A details screen of the operation status of each indoor unit (R.C. Group) can be checked.

- (1) Press the [$\leftarrow\rightarrow$] button and select the indoor unit (R.C. Group).
- (2) When the [Details (F5)] button is pressed, the “Details” screen opens.
- (3) Check the operation status details screen.

Details - List1

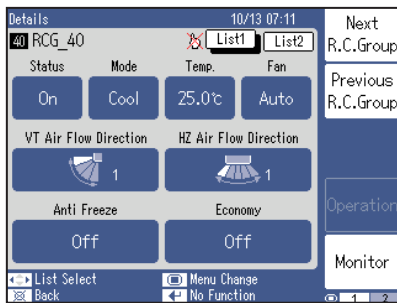

Fields with no function at all the indoor units registered at R.C. group are displayed by a blank field.

Press the [$\leftarrow\rightarrow$] button and select “List 1”.

Press the [$\leftarrow\rightarrow$] button and select “List 2”.

Details - List2

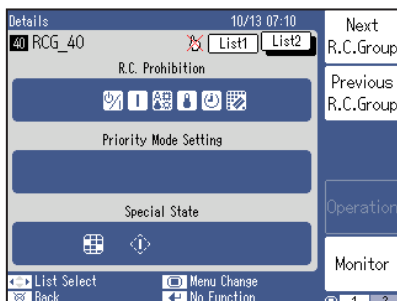







- [Next R.C. Group (F1)] : Opens the detailed screen of the indoor unit (R.C. Group) of the next number.
- [Previous R.C. Group (F2)] : Opens the details screen of the indoor unit (R.C. Group) of the previous number.
- [Monitor(F5)] : Returns to the Monitor mode screen.

Item	Status
Status	Operation On/Off setting
Mode	Operation mode setting
Temp.	Temperature setting
Fan	Fan speed setting
VT Air Flow Direction	Vertical air flow direction angle setting
HZ Air Flow Direction	Horizontal air flow direction angle setting
Anti freeze	Anti freeze setting
Economy	Economy setting

See “3-2-5 Temperature Unit Setting” for Celsius (°C) and Fahrenheit (°F) switching.











Icon Display List - R.C. Prohibition

Icon	Name	Contents
	All	Standard remote controller all operations prohibited
	On/Off	Standard remote controller ON/Off operation prohibited
	On	Standard remote controller ON operation prohibited
	Mode	Standard remote controller operation mode prohibited
	Temp.	Standard remote controller temperature setting operation prohibited
	Timer	Standard remote controller timer setting operation prohibited
	Filter	Standard remote controller filter reset operation prohibited

Priority Mode Setting List

Name	Contents
Master indoor unit	Indoor unit has the cooling and heating selection right.
Master controlled	Indoor unit is controlled by an indoor unit with the cooling and heating selection right.
Outer controlled	Indoor unit is controlled by an outdoor unit with the cooling and heating selection right.

Icon Display List - Special State

Icon	Name	Contents
	Defrost	Defrost Operation.
	Oil Recovery	Oil recovery operation.
	Filter Sign	Filter cleaning alarm sign.
	Mode Mismatch	Different operation mode.
	Test Operation	Test operation.
	Under Maintenance	System is in the maintenance mode and the equipment cannot be operated.
	Operation Controlled	Operation is restricted by any function.
	Error	Error
	Emergency Stop	Emergency Stop
	Operation Restricted	Indoor units and outdoor units operation mode is under control.

2 CONTROL

2-1 Control

2-1-1 Operation Setting display

Operation Setting

Monitor-All

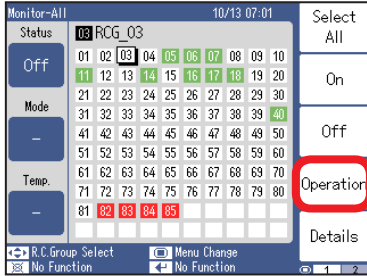

Monitor-Group

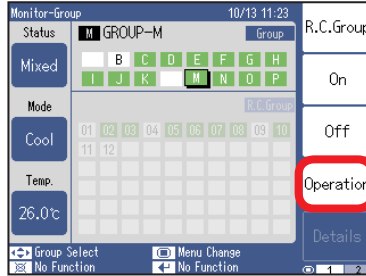

Details

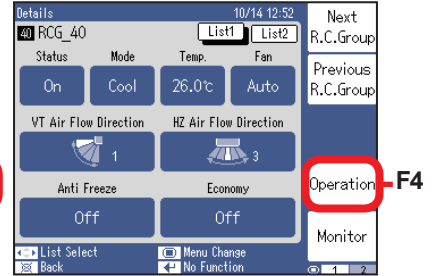

[Operation(F4)] button

Switch to the "Operation Setting" screen.

- (1) Press the [] button and select the indoor unit (R.C. Group , Group).
- (2) When the [Operation (F4)] button is pressed, the "Operation Setting" screen opens.
- (3) Press the [] button and select the function you want to set.
- (4) Press the Function button and set the function.
The functions list is shown on the "Description of Function" list.
The Function button is different depending on the item to be set.
- (5) Press the [] button.

Operation Setting

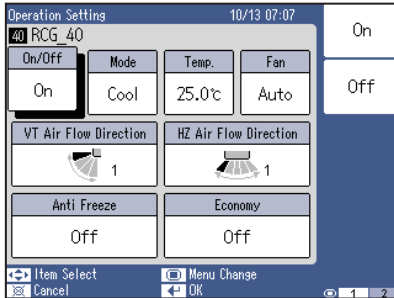

Description of Functions

	Name	Function	Contents	Contents										
1	On/Off	On	(F1)	Sets the operation "On".	The operation On/Off is set.									
		Off	(F2)	Sets the operation "Off".										
2	Mode	Auto	(F1)	Sets the "Auto" mode.	<ul style="list-style-type: none"> •The operation mode is set. •When the function does not exist at the objective unit, setting cannot be selected. •When  is displayed, the selection of cooling and heating is limited. 									
		Cool	(F2)	Sets the "Cool" mode.										
		Dry	(F3)	Sets the "Dry" mode.										
		Fan	(F4)	Sets the "Fan" mode.										
		Heat	(F5)	Sets the "Heat" mode.										
3	Temp.	Up	(F1)	Raises the set temperature.	<ul style="list-style-type: none"> •The set temperature is raised or lowered in 0.5°C steps for Celsius display and in 1°F steps for Fahrenheit display. •The temperature range is different depending on the operation mode. The set temperature range set at the factory is as follows: <table border="1" data-bbox="729 517 1263 602"> <thead> <tr> <th>Mode</th> <th>Celsius (°C)</th> <th>Fahrenheit (°F)</th> </tr> </thead> <tbody> <tr> <td>Auto, Cool, Dry</td> <td>18-30</td> <td>64-88</td> </tr> <tr> <td>Heat</td> <td>10-30</td> <td>48-88</td> </tr> </tbody> </table> <ul style="list-style-type: none"> * The settable temperature range can be changed. For details, see "Set Temp. Range Setting" (par. 3-2-8). * Depending on the model of indoor unit, the settable range may be restricted. For details, refer to the indoor unit manual. 	Mode	Celsius (°C)	Fahrenheit (°F)	Auto, Cool, Dry	18-30	64-88	Heat	10-30	48-88
		Mode	Celsius (°C)	Fahrenheit (°F)										
Auto, Cool, Dry	18-30	64-88												
Heat	10-30	48-88												
Down	(F2)	Lowers the set temperature.												
4	Fan	Up / Down	(F1/ F2)	Sets the fan speed. (including Auto mode)	<ul style="list-style-type: none"> •Fan speed is set. •When the function does not exist at the objective unit, setting cannot be selected. 									
5	VT Air Flow Direction	Up	(F1)	Moves the louver to the upper side.	<ul style="list-style-type: none"> •Air Flow Direction (Up/Down) is set. •The louver angle setting is different depending on the indoor unit. •When the function does not exist at the objective unit, setting cannot be selected. 									
		Down	(F2)	Moves the louver to the lower side.										
6	HZ Air Flow Direction	Left	(F1)	Moves the louver to the left side.	<ul style="list-style-type: none"> •Air Flow Direction (Right/Left) is set. •The louver angle setting is different depending on the indoor unit. •When the function does not exist at the objective unit, setting cannot be selected. 									
		Right	(F2)	Moves the louver to the right side.										
7	Anti Freeze	On	(F1)	Sets "On".	<ul style="list-style-type: none"> •Anti Freeze is a function that performs low temperature heating operation to prevent freezing of water lines and equipment, when air conditioning operation is off, in regions where outside temperature may drop below freezing. If water lines are far from the unit or within exterior walls, this function may not provide enough anti freeze protection. •When the function does not exist at the objective unit, setting cannot be selected. 									
		Off	(F2)	Sets "Off".										
8	Economy	On	(F1)	Sets "On".	<ul style="list-style-type: none"> •When the function does not exist at the objective unit, setting cannot be selected. 									
		Off	(F2)	Sets "Off".										

3 SETTING

3-1 Setup Menu

3-1-1 Shifting to Setup Menu

When performing manager and installer setup menu, proceed as follows:

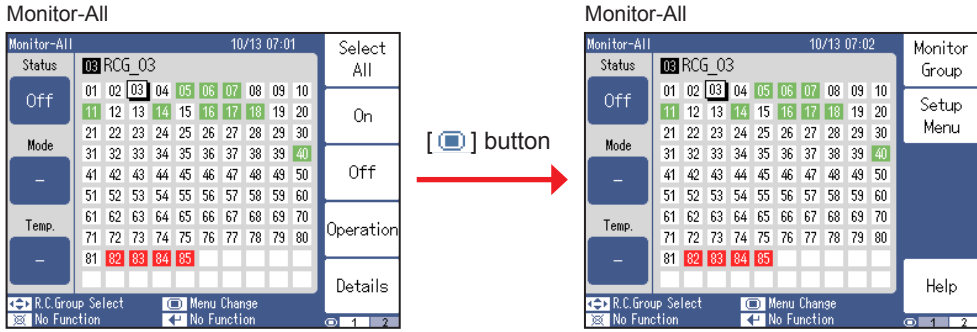

Press the [Setup Menu (F2)] button. The screen can be also shifted to "Setup Menu" from "Monitor-Group" screen or "Details" screen.

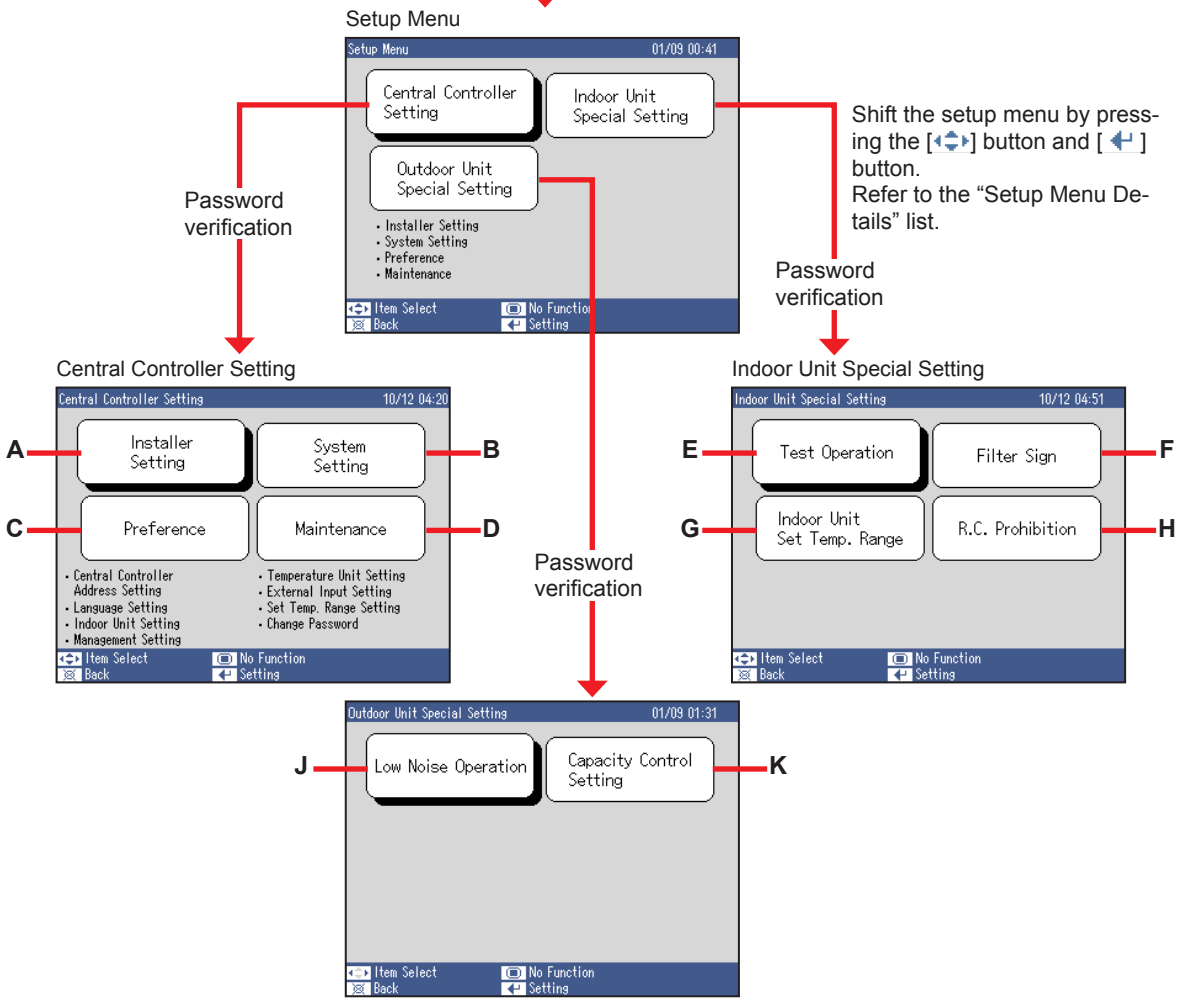

“Setup Menu Details” List

	Item (1st)	Item (2nd)	(Function button)	Item (3rd) or supplementary description	Par. No.	
A	Installer Setting	Central Controller Address Setting	-	-	3-2-2	
		Language Setting	-	-	3-2-3	
		Indoor Unit Setting	Address Number(F1)		Registering indoor units in refrigerant system addresses order	3-2-4-1
			Operation(F2)		Registering indoor units in operation order	3-2-4-2
			Manual (F3)		Registering indoor units manually	3-2-4-3
			Order Change(F2)		Changing the order of the registered indoor units	3-2-4-4
			Delete(F5)		Deleting registered indoor units	3-2-4-5
			Rename (F1)		Changing the name of the R.C. Group	3-2-4-6
		Temperature Unit Setting	-	-	3-2-5	
		Management Setting	-	-	3-2-6	
		External Input Setting	-	-	3-2-7	
		Set Temp. Range Setting	-	-	3-2-8	
Change Password (for installer)	-	-	3-2-9			
B	System Setting	Date Setting	→	Date and Time setting	3-3-2-1	
			→	Date and Time display format setting	3-3-2-2	
			→	Summer time setting	3-3-2-3	
			→	Automatic system clock adjustment setting	3-3-2-4	
			→	Current time transmission	3-3-2-5	
		Group Setting	→	Group Edit	3-3-3-1	
			→	R.C.Group Edit	3-3-3-2	
		Schedule Setting	Rename (F1)		Renaming Schedule	3-3-4-1
			Unit Change(F2)		Setting a Group or R.C. Group to be operated on a schedule	3-3-4-2
			Timer Change(F3)		Setting and correction of schedule timer	3-3-4-3
			Timer Change(F3)		Schedule timer Copy/Paste	3-3-4-4
			On/Off Setting(F4)		Setting schedule on/off	3-3-4-5
			Data Operation(F5)		Schedule Copy/Paste	3-3-4-6
		Password Setting (for manager)	Data Operation(F5)		Schedule initialization	3-3-4-7
			→	Changing the manager password	3-3-5-1	
		→	Manage the manager access right	3-3-5-2		
C	Preference	Backlight Setting	-	-	3-4-2	
		Display Setting	-	-	3-4-3	
		Sound Setting	-	-	3-4-4	
D	Maintenance	Error History	-	-	3-5-2	
		Version	-	-	3-5-3	
		Setting Status List	-	-	3-5-4	
E	Test Operation				3-6-2	
F	Filter Sign				3-6-3	
G	Indoor Unit Set Temp. Range				3-6-4	
H	R.C.Prohibition				3-6-5	

J	Low Noise Operation	3-7-2
K	Capacity Control Setting	3-7-3

* The marks A to K are linked to the marks at the leading line of par. 3-1-1 screens.

3-2 Installer Setting

3-2-1 Installer Setting screen

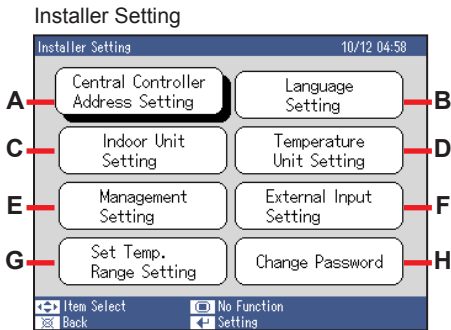

- (1) Password is set so that this controller is not used by unauthorized persons.
When the screen requesting the password opens, enter the password.

Note

- ◆ "0000" is set as the default password.
If the password is changed, see "3-2-9 Change password".

- (2) Press the [↕] button and move the cursor to the item you want to set.
A: Central Controller Address Setting : Par. 3-2-2
B: Language Setting : Par. 3-2-3
C: Indoor Unit Setting : Par 3-2-4
D: Temperature Unit Setting : Par 3-2-5
E: Management Setting : Par 3-2-6
F: External Input Setting : Par 3-2-7
G: Set Temp. Range Setting : Par 3-2-8
H: Change Password (for installer) : Par 3-2-9
- (3) Press the [←] button.
Each setting screen opens.

3-2-2 Central Controller Address Setting

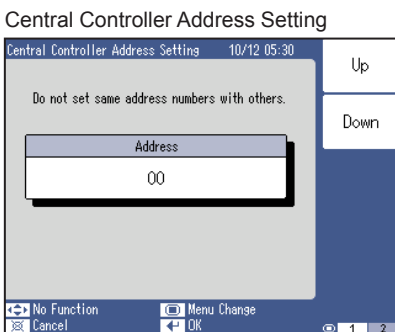

- (1) Press the [UP (F1)] button or [Down (F2)] button.
Set the Address value.
◆ The Address value can be set from 00 to 15.
- (2) When the [←] button is pressed, setting is complete.

Note

VRF system can connect up to 16 units of touch panel controller, network convertor, Central remote controller, and Lon-Lon convertor. When setting the address of this unit, be sure the address (number) does not duplicate that of other unit.

3-2-3 Language Setting

Language Setting

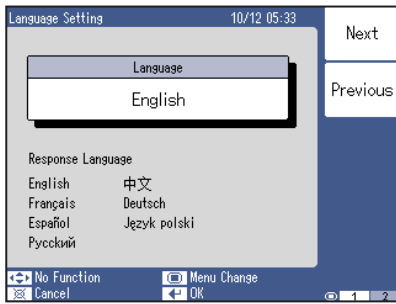

- (1) Press the [Next (F1)] button or [Previous (F2)] button. Language can be set.
- (2) When the [] button is pressed, setting is complete.

3-2-4 Indoor Unit Setting

Indoor Unit Setting

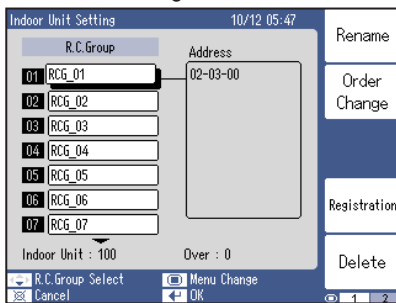

Register the indoor units at the Central remote controller. The registration method can be selected from the following 3 methods:

- (1) Automatic registration of indoor units in ascending order of refrigerant system address
- (2) Automatic registration in indoor unit operation order
- (3) Manual registration of indoor units

To register indoor units press [Registration (F4)].

[Rename(F1)] : Changes the name of the R.C. Group. (Par. 3-2-4-6)

[Order Change(F2)] : Changes the order of the registered indoor units. (Par. 3-2-4-4)

[Registration(F4)] : Registers indoor units.

[Delete(F5)] : Deletes registered indoor units. (Par. 3-2-4-5)

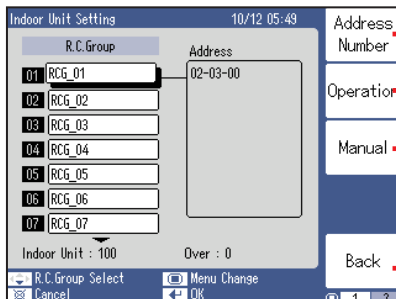

Address Number — Registering indoor units in refrigerant system addresses order (Par. 3-2-4-1)

Operation — Registering indoor units in operation order (Par. 3-2-4-2)

Manual — Registering indoor units manually (Par. 3-2-4-3)

Back — Return to the previous screen.

Notice

Indoor unit registration and deletion may affect the group setting and schedule setting.

Always confirm after the end of indoor unit setting when group setting and schedule setting have already been performed.

3-2-4-1 Registering indoor units in refrigerant system addresses order

Address Number Registration

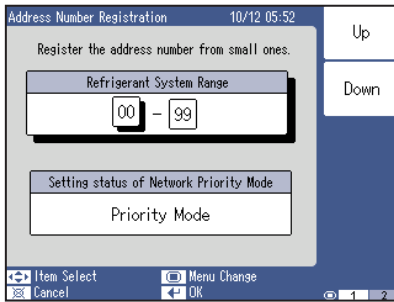

Automatically register indoor units in refrigerant system address ascending order.

Press the [Address Number (F1)] button after pressing the [Registration (F4)] button from "Indoor Unit Setting" screen.

- (1) Set the start refrigerant system address (number) of the "Refrigerant System Range".
Move the cursor to the left side of the "Refrigerant System Range" menu.
Press the [UP (F1)] button or [Down (F2)] button.
- (2) Set the end refrigerant system address (number) of the "Refrigerant System Range".
Move the cursor to the right side of the "Refrigerant System Range" menu.
Press the [UP (F1)] button or [Down (F1)] button.
- (3) Move the cursor to the "Setting status of Network Priority Mode" item.
Press the [Priority Mode(F1)] button or [Normal (F2)] button.

Note

When scanning is performed in the "Priority Mode", operation of all the units in the system stops. (Recommended setting)
When you do not want to stop operation, perform scanning in the Normal mode.

- (4) When the [↵] button is pressed, a confirmation screen opens.
- (5) When the [↵] button is pressed again, scanning starts.

Note

When there is an abnormality in the system, an error screen is displayed and registration is stopped.

Notes

System abnormality

Abnormality contents	Cause
No outdoor unit	No outdoor unit of the same refrigerant system address as indoor unit.
No indoor unit	Not even 1 indoor unit at the same refrigerant system address as outdoor unit.
There is an abnormality in unit setting.	There is an abnormality in unit data setting.
There is an abnormality in RCG address.	There is an abnormality in RCG address setting.
No master unit at outdoor units.	There is no master unit at the outdoor units.
Initializing	Cannot be executed because initializing at other unit.

3-2-4-2 Registering indoor units in operation order

Operation Order Registration

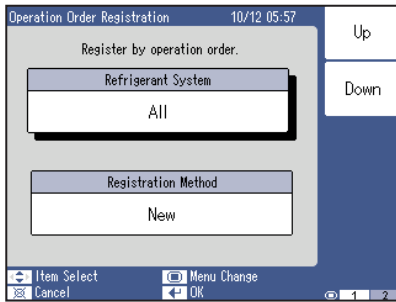

Register indoor units in operation order.

Press the [Operation (F2)] button after pressing the [Registration (F4)] button from “Indoor Unit Setting” screen.

- (1) Move the cursor to the “Refrigerant System” menu.
Press the [UP (F1)] button or [Down (F2)] button.
Select “Refrigerant system address (number)” or “All (all refrigerant systems)”.
When set to “All”, operation of all the units in the system stops.
When “Refrigerant system address (number)” is selected, the selected refrigerant system stops operating, but systems other than the selected refrigerant system do not stop operating.
- (2) Move the cursor to the “Registration Method” menu.
[New (F1)] button : Registers indoor units after canceling all the currently registered indoor units.
[Add (F2)] button : Registers indoor units by adding them to the currently registered indoor units.
- (3) When the [] button is pressed, a confirmation screen opens.
- (4) When the [] button is pressed again, system confirmation starts.
- (5) If system confirmation ends normally, the “Indoor Unit Setting” screen opens.

Note

When there is an abnormality in the system, an error screen is displayed and registration is stopped.

- Operation of the indoor units starts in the order you want to register.
The remote controller group is displayed on the “Indoor Unit Setting” screen in the order operation started.
- (6) When stopping “Register by operation order”, press the [End (F5)] button.
 - (7) When the [] button is pressed, the confirmation screen closes.
 - (8) When the [] button is pressed, setting is complete.

3-2-4-3 Registering indoor units manually

Manual Registration

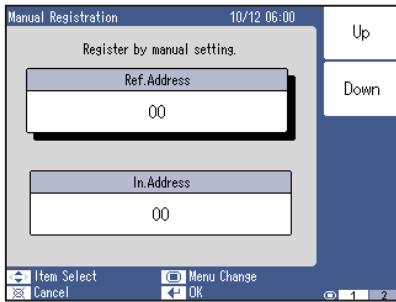

Register indoor units of the entered remote controller group address. Press the [Manual (F3)] button after pressing the [Registration (F4)] button from “Indoor Unit Setting” screen.

- (1) Move the cursor to the “Ref. Address” menu.
Press the [Up (F1)] button or [Down (F2)] button and select “Ref. Address (Number)”.

Notice



When there is a slave (Remote controller Address 01 or higher) in an R.C. Group, register only the master unit (Remote controller Address 00). When the master unit is registered the slave indoor unit is automatically registered.

- (2) Move the cursor to the “In. Address” menu.
Press the [Up (F1)] button or [Down (F2)] button and select “Indoor unit address (Number)”.
- (3) When the [] button is pressed, setting is complete.

3-2-4-4 Changing the order of the registered indoor units

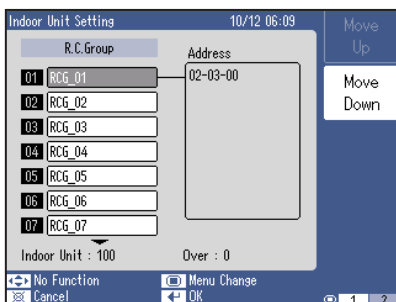
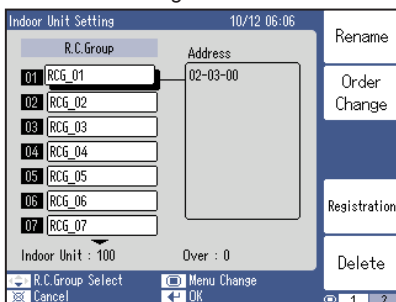
Indoor Unit Setting



- (1) Press the [] button and move the cursor to “R.C.Group” to be moved.
- (2) Press the [Order Change (F2)] button.
The “R.C. Group” to be moved is selected.
- (3) Press the [Move Up (F1)] button or [Move Down (F2)] button and move the cursor to the move destination.
- (4) When the [] button is pressed, setting is complete.

3-2-4-5 Deleting registered indoor units

Indoor Unit Setting

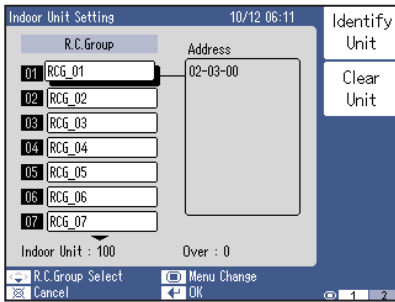

When the [Delete (F5)] button is pressed at the “Indoor Unit Setting” screen, this screen opens.

- (1) Press the [←→] button and move the cursor to the “R.C. Group” name to be deleted.
- (2) Press the [Identify Unit (F1)] button
- (3) Press the [←] button.
- (4) When the [←] button is pressed again after the confirmation screen opens, deletion is complete.

3-2-4-6 Changing the name of the R.C. Group

R.C. Group Name

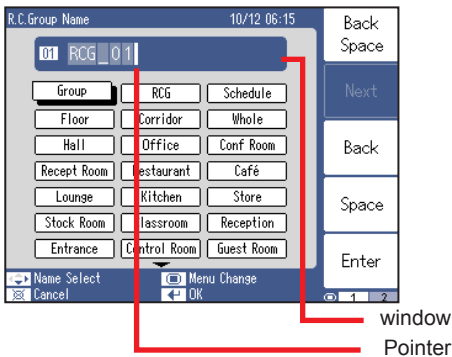

When pressing the [Rename (F1)] button at “Indoor Unit Setting” screen, this screen opens.

- (1) Press the Function button and change the name.
 - [Back Space(F1)] button : Deletes the character at the left side of the pointer in the window.
 - [Next(F2)] button : Moves the position of the pointer in the window to the right side.
 - [Back(F3)] button : Moves the position of the pointer in the window to the left side.
 - [Space(F4)] button : Inserts a space.
 - [Enter (F5)] button : Adds the name selected by the cursor using [←→] button in the window.

- (2) When the [←] is pressed, the setting is fixed.
(To cancel the setting, press the [✖] button.)

Note

- ◆ A temporary name is input at the factory.
- ◆ The number of enterable characters is 12 (7 for Chinese).
- ◆ When the characters exceed the number of enterable characters, “Over” message appears in the right side of the window.

3-2-5 Temperature Unit Setting

Temperature Unit Setting

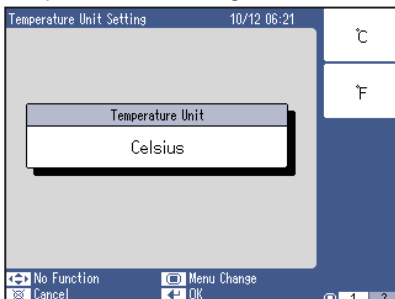

- (1) [°C(F1)] button : Selects Celsius.
[°F(F2)]button : Selects Fahrenheit.
- (2) When the [←] button is pressed, setting is complete.

3-2-6 Management Setting

Management Setting

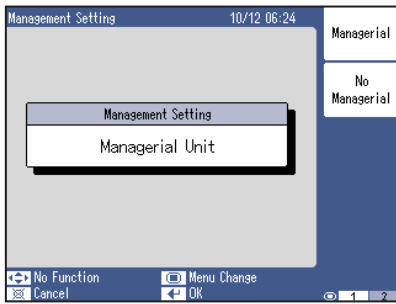

- (1) [Managerial(F1)] button : Sets a managerial unit.
[No Managerial(F2)] button : Does not set a managerial unit.

Note

When set to “No Managerial”, the following functions cannot be set:

- Indoor Unit Set Temp. Range
- R.C.Prohibition
- Master setting of System Clock Adjustment

3-2-7 External Input Setting

External Input Setting

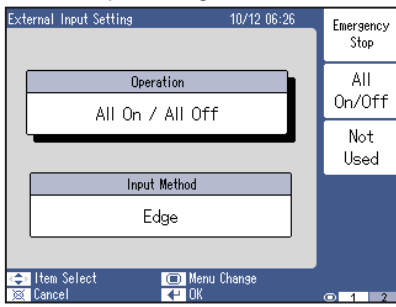

Set the “External Input Setting”.

- (1) Press the [↔] button and move the cursor to the “Operation” menu.
[Emergency Stop(F1)] button : Enables Emergency stop by external input.
[All On/Off (F2)] button : Enables batch operation On/Off by external input.
[Not Used (F3)] button : Does not receive external input signals.
- (2) Press the [↔] button and move the cursor to the “Input Method” menu.
[Edge(F1)] button : Detects the signal rise and fall.
[Pulse (F2)] button : Detects the signal level.
- (3) When the [↩] button is pressed, setting is complete.

3-2-8 Set Temp. Range Setting

Set Temp. Range Setting

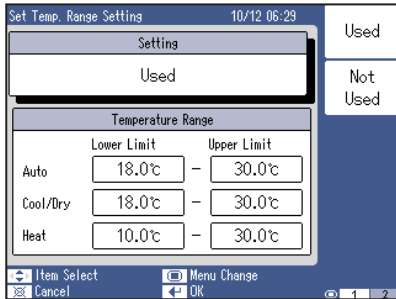

Set the settable temperature range of the central remote controller for each operation mode.

- (1) Press the [$\leftarrow \rightarrow$] button and move the cursor to the “Setting” menu.
 [Used (F1)] button : Set.
 [Not Used (F2)] button : Not set. (Factory setting)
- (2) Press the [$\leftarrow \rightarrow$] button and move the cursor to the “Temperature Range” menu you want to set.
 [Up (F1)] button : Raises the set value.
 [Down (F2)] button : Lowers the set value.
- (3) When the [\leftarrow] button is pressed, setting is complete.

Settable temperature range

Mode	Celsius	Fahrenheit
“Auto”, “Cool/Dry”	18°C to 30°C	64°F to 88°F
“Heat”	10°C to 30°C	48°F to 88°F

3-2-9 Change Password (For installer)

Change Password

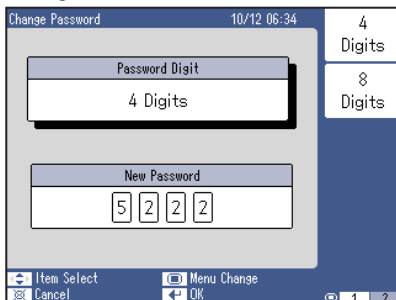

Change the password for installer.

Note

The default password is “0000” (4 digits).

- (1) Press the [$\leftarrow \rightarrow$] button and move the cursor to the “Password Digit” menu.
 [4 Digits (F1)] button : Sets to 4 digits.
 [8 Digits (F2)] button : Sets to 8 digits.
- (2) Press the [$\leftarrow \rightarrow$] button and move the cursor to the number of the “New Password” menu.
 [Up (F1)] button : Raises the value.
 [Down (F2)] button : Lowers the value.
- (3) When the [\leftarrow] button is pressed, setting is complete.

Note

- If you forget the password after password change (setting) was performed, subsequent installer setting will be impossible.
- Enter the password in the password control table at the back cover of the operating manual (printed matter) so as not to forget it.
- If you forget a password, contact your local dealer.

3-3 System Setting

3-3-1 System Setting screen

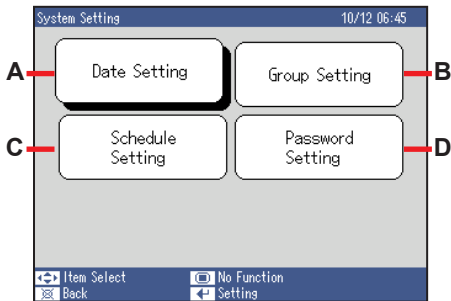

- (1) Press the [↔] button from the “System Setting” screen and move the cursor to the menu you want to set.

A: Date Setting : Par. 3-3-2

B: Group Setting : Par. 3-3-3

C: Schedule Setting : Par. 3-3-4

D: Password Setting (for manager) : Par. 3-3-5

- (2) Press the [↵] button.
The next selection screen opens.

3-3-2 Date Setting

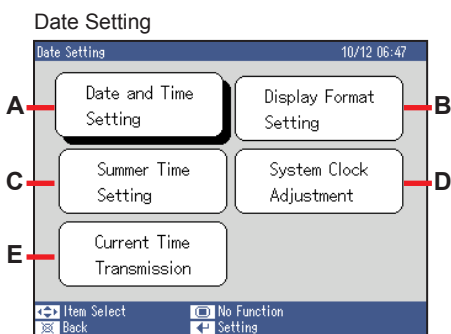

- (1) Press the [↔] button and move the cursor to the item you want to set.

A: Date and Time Setting : Par. 3-3-2-1

B: Display Format Setting : Par. 3-3-2-2

C: Summer Time Setting : Par. 3-3-2-3

D: System Clock Adjustment : Par. 3-3-2-4

E: Current Time Transmission : Par. 3-3-2-5

- (2) Press the [↵] button.
The setting screen opens.

3-3-2-1 Date and Time setting

Date and Time Setting

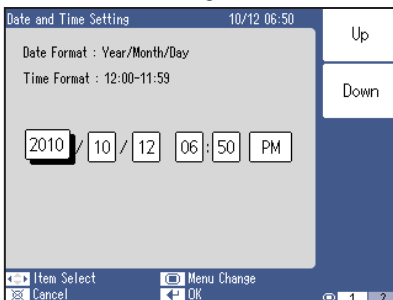

Set the current date, time, and AM/PM.

- (1) Press the [↔] button and move the cursor to the item you want to set.

Press the [UP (F1)] button or [Down (F2)] button.

- (2) When the [↵] button is pressed, setting is complete.

3-3-2-2 Date and Time display format setting

Display Format Setting

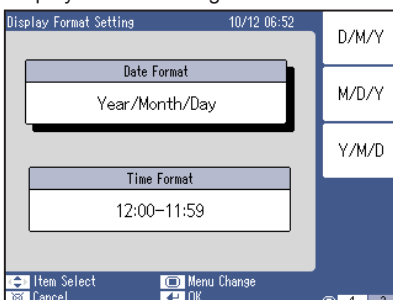

- (1) Press the [↔] button and move the cursor to the “Date Format” menu.

[D/M/Y (F1)] button : Day/Month/Year

[M/D/Y (F2)] button : Month/Day/Year

[Y/M/D (F3)] button : Year/Month/Day

- (2) Press the [↔] button and move the cursor to the “Time Format” menu.

[12:00-11:59(F1)] button : 12:00-11:59 AM/PM

[00:00-11:59(F2)] button : 00:00-11:59 AM/PM

[00:00-23:59(F3)] button : 00:00-23:59

- (3) When the [←] button is pressed, setting is complete.

3-3-2-3 Summer time setting

Summer Time Setting

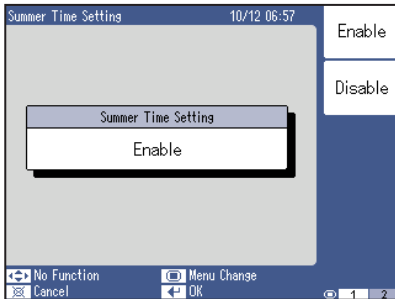

- (1) Press the Function button and select the following items:
[Enable(F1)] button : Sets to summer time display.
[Disable(F2)] button : Does not set to summer time display.
- (2) When the [←] button is pressed, setting is complete.

Notes

See the table shown below for the items which can be selected.

Item	Display contents
"Enable"	Display 1 hour ahead of the current time*.
"Disable"	Display the current time*.

3-3-2-4 Automatic system clock adjustment setting

System Clock Adjustment

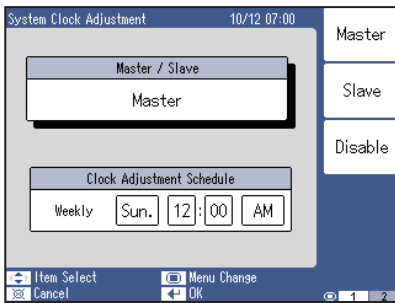

The clock of the units in the system can be adjusted.

- (1) Press the [←] button and move the cursor to the "Master/Slave" menu.
[Master (F1)] button : Makes this remote controller the master unit for the automatic clock adjustment of the entire system.
[Slave (F2)] button : Matches the clock of this remote controller to the clock of the other unit which is the master unit.
[Disable (F3)] button : Automatic clock adjustment function is not performed (Unaffected by the master clock setting.)

Note

Set the only 1 master unit in the system.

- When "Master" was set, also perform the following setting:
- (2) Press the [←] button and move the cursor to the "Clock Adjustment Schedule" menu item you want to set. Select each item (day of week, time, AM/PM) with the Function button.
 - (3) When the [←] button is pressed, setting is complete.

Note

- When the clock adjustment is performed, set to perform the clock adjustment late at night, etc. when operation is stopped and the timer is not operating.
- When the power of this unit goes OFF, correct operation may not be performed.

System Clock Adjustment

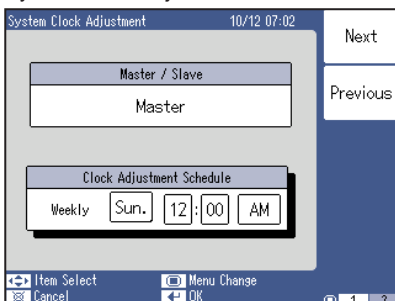

3-3-2-5 Current time transmission

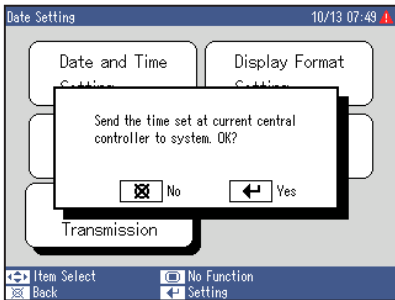

Send the time data set at the Central remote controller to each unit in the system.

- (1) When the [←] is pressed, sending the data starts.
 - ◆ A "Sending data" screen opens.
 - At the end of sending, the screen closes.

Notice

This function is effective only when "Master" of "Master/Slave" setting of "System Clock Adjustment" screen is set.

3-3-3 Group Setting

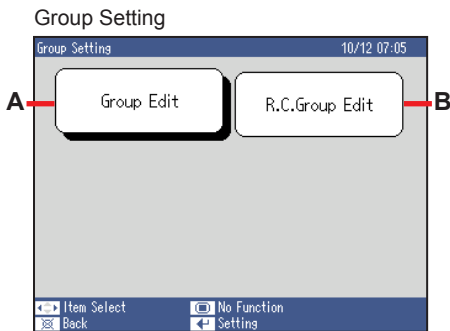

Group an R.C. Group, and edit an R.C. Group.

- (1) Press the [←] button and select the menu you want to set.
 - A: Group Edit : Par.3-3-3-1
 - B: R.C.Group Edit : Par. 3-3-3-2
- (2) Press the [←] button.

3-3-3-1 Group Edit

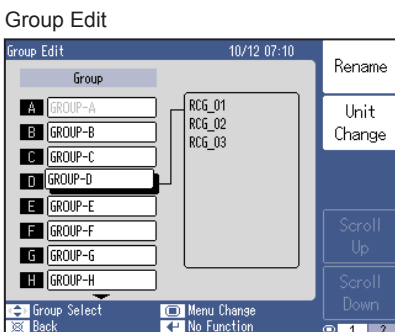

Rename a "Group", and group and register an "R.C. Group".

- (1) Press the [←] button and move the cursor to the group you want to change.
 - A: Renaming a "Group"
 - Press the [Rename (F1)] button. (See par. 3-3-3-1-1.)
 - B: Registering an R.C. Group at Group
 - Press the [Unit Change (F2)] button. (See par. 3-3-3-1-2.)

3-3-3-1-1 Renaming a Group

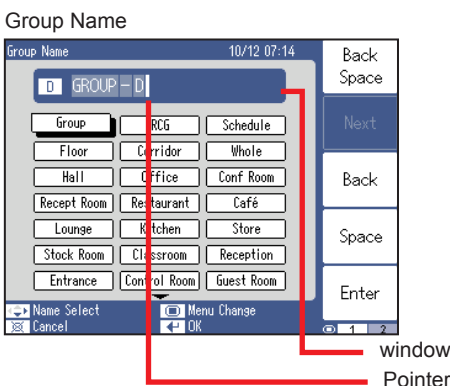

- (1) Edit the name using the following buttons:
 - [Back Space(F1)] button : Deletes the character at the left side of the pointer in the window.
 - [Next(F2)] button : Moves the position of the pointer in the window to the right side.
 - [Back(F3)] button : Moves the position of the pointer in the window to the left side.
 - [Space(F4)] button : Inserts a space.
 - [Enter(F5)] button : Adds the name selected by the cursor using [←] button in the window.

- (2) When the [←] is pressed, the setting is fixed.
(To cancel the setting, press the [✖] button.)

Note

- ◆ A temporary name is input at the factory.
- ◆ The number of characters that can be entered is 12 (7 for Chinese).
- ◆ When the characters exceed the number of enterable characters, “Over” message appears in the right side of the window.

3-3-3-1-2 Registering an R.C. Group at Group

Unit Registration Setting

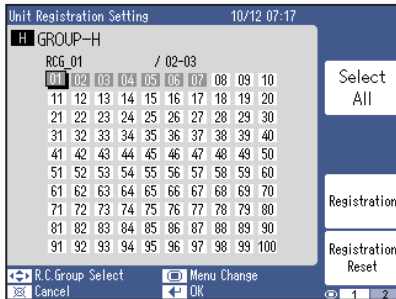

Register an “R.C. Group” at “Group”, or change a group registered “R.C. Group”.

- (1) Press the [←] button and move the cursor to an “R.C. Group”.
 - ◆ When the [Select All (F2)] button is pressed, all the R.C. Groups (number) that can be grouped are selected.
 - ◆ When the [Clear All (F2)] button is pressed while all the R.C. Groups are selected, the selected R.C. Groups are canceled.
- (2) [Registration (F4)] button : Registers.
[Registration Reset (F5)] button : Cancels the registration.
- (3) Register R.C. Groups by repeating steps (1) and (2).
- (4) When the [←] button is pressed, setting is complete.

3-3-3-2 R.C.Group Edit

R.C.Group Edit

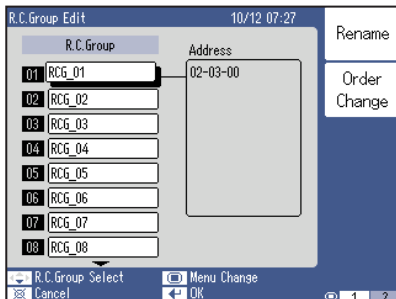

Rename an “R.C. Group” and change the “R.C. Group” registration order.

- (1) Move the cursor to the “R.C. Group” you want to change.
 - A: Renaming an “R.C. Group”
→ Press the [Rename (F1)] button. (See par. 3-3-3-2-1.)
 - B: Changing the registered “R.C. Group” order.
→ Press the [Order Change (F2)] button. (See par.3-3-3-2-2.)

3-3-3-2-1 Renaming an R.C. Group

R.C.Group Name

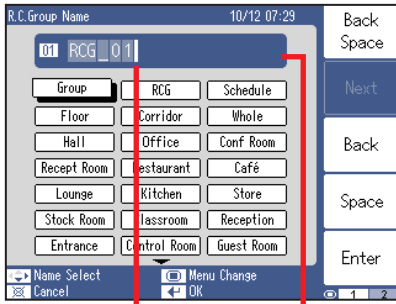

Window Pointer

- (1) Edit the name using the following buttons:
 - [Back Space(F1)] button : Deletes the character at the left side of the pointer in the window.
 - [Next(F2)] button : Moves the position of the pointer in the window to the right side.
 - [Back(F3)] button : Moves the position of the pointer in the window to the left side.
 - [Space(F4)] button : Inserts a space.
 - [Enter(F5)] button : Adds the name selected by the cursor using [↔] button in the window.
- (2) When the [↔] is pressed, the setting is fixed. (To cancel the setting, press the [X] button.)

Note

- ◆ A temporary name is input at the factory.
- ◆ The number of characters that can be entered is 12 (7 for Chinese).
- ◆ When the characters exceed the number of enterable characters, "Over" message appears in the right side of the window.

3-3-3-2-2 Changing the registered R.C. Group order

R.C.Group Edit

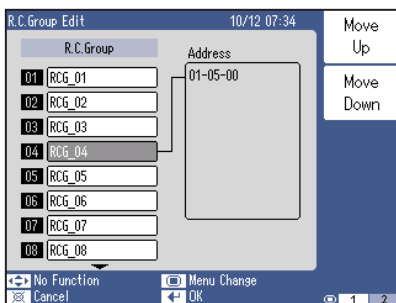
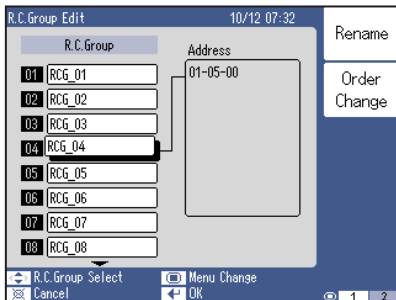

- (1) Press the [↔] button and move the cursor to "R.C. Group" to be moved.
- (2) Press the [Order Change (F2)] button. The R.C. Group to be moved is selected.
- (3) Press the "Move Up (F1)" or "Move Down (F2)" button and move the R.C. Group name to the destination.
- (4) When the [↔] button is pressed, setting is complete.

3-3-4 Schedule Setting

Schedule Setting

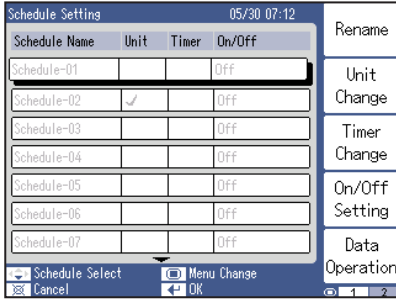

Set a schedule. Up to 16 schedules can be created. A schedule is not set at the factory.

- (1) Press the [$\leftarrow\rightarrow$] button and move the cursor to the item you want to set.
- (2) The following setting can be performed at “Schedule Setting”.
 - A: Renaming a schedule
→Press the [Rename(F1)] button. (See par. 3-3-4-1.)
 - B: Setting a Group or R.C. Group to be operated on a schedule
→Press the [Unit Change(F2)] button. (See par. 3-3-4-2.)
 - C: Setting and correction of schedule timer
→Press the [Timer Change(F3)] button. (See par. 3-3-4-3.)
 - D: Schedule timer Copy/Paste
→Press the [Timer Change(F3)] button. (See par. 3-3-4-4.)
 - E: Setting schedule on/off
→Press the [On/Off Setting(F4)] button. (See par. 3-3-4-5.)
 - F: Schedule Copy/Paste
→Press the [Data Operation (F5)] button. (See par. 3-3-4-6.)
 - G: Schedule initialization
→Press the [Data Operation (F5)] button.(See par.3-3-4-7.)

Note

- When the power of this unit goes OFF, correct operation may not be performed.

3-3-4-1 Renaming a Schedule

Schedule Name

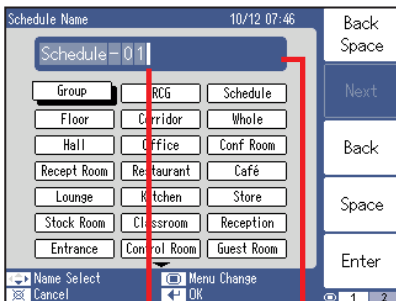

- (1) Edit the name using the [$\leftarrow\rightarrow$] button and the Function buttons.
 - [Back Space(F1)] button : Deletes the character at the left side of the pointer in the window.
 - [Next(F2)] button : Moves the position of the pointer in the window to the right side.
 - [Back(F3)] button : Moves the position of the pointer in the window to the left side.
 - [Space(F4)] button : Inserts a space.
 - [Enter(F5)] button : Adds the name selected by the cursor using [$\leftarrow\rightarrow$] button in the window.
- (2) When the [\leftarrow] is pressed, the setting is fixed. (To cancel the setting, press the [\cancel] button.)

Note

- A temporary name is input at the factory.
- The number of characters that can be entered is 12 (7 for Chinese).
- ◆ When the characters exceed the number of enterable characters, “Over” message appears in the right side of the window.

3-3-4-2 Setting a Group or R.C. Group to be operated on a schedule

Unit Registration Setting

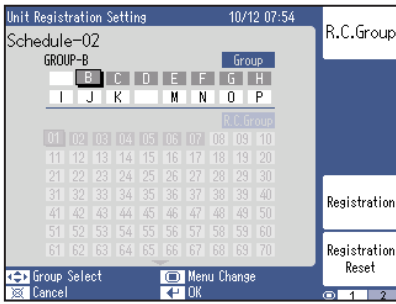

[Group(F1)]
button

R.C.Group(F1)
button

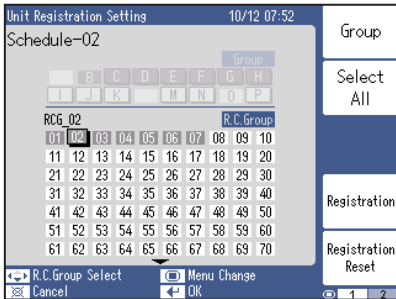
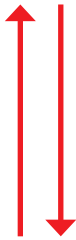

Register and cancel a group or R.C. Group to be operated on a schedule. At the R.C. Group screen, select the R.C. group to be scheduled from all the R.C. Groups registered at the Central remote controller.

At the "Group" screen, register the R.C. Group on a schedule for each group.

- (1) Press the [←→] button and move the cursor to the Group (number).
- (2) [Registration (F4)] button : Registers.
[Registration Reset (F5)] button : Cancels the registration.
- (3) When the [←] is pressed, the setting is fixed.
(To cancel the setting, press the [⊗] button.)

- (1) Press the [←→] button and move the cursor to the indoor unit (number) you want to register on a schedule.
 - ◆ When the [Select All (F2)] button is pressed, all the indoor units are selected. (When the [Clear All (F2)] button is pressed while all the indoor units are being selected, selection is canceled.)
- (2) [Registration (F4)] button : Registers.
[Registration Reset (F5)] button : Cancels the registration.
- (3) When the [←] is pressed, the setting is fixed.
(To cancel the setting, press the [⊗] button.)

3-3-4-3 Setting and correction of schedule timer

Timer Setting

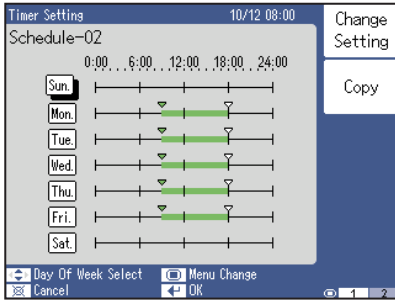

Newly set the schedule timer or correct a set schedule timer.

- (1) Press the [↔] button and move the cursor to the day of week you want to set.
- (2) Press the [Change Setting(F1)] button.

Timer Change

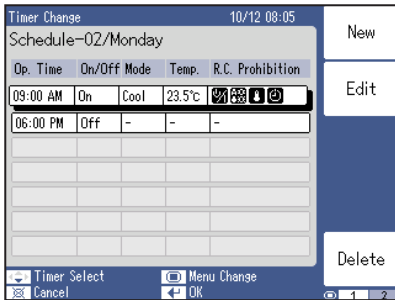

- (3) When setting a schedule timer newly
Press the [New(F1)] button.
When changing a schedule timer that is already set.
Press the [Edit (F2)] button.
“Operation Setting” screen opens.

◆ When the [Delete (F5)] button is pressed, setting of the selected schedule timer is deleted.

When schedule setting is input

Timer Change

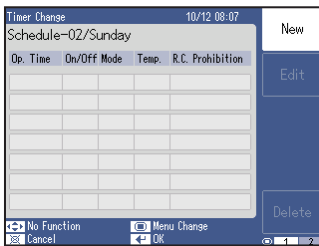

When schedule setting is not input

Operation Setting

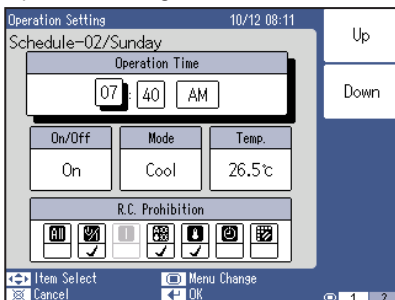

- (4) Press the [↔] button and move the cursor to the item you want to set.
- (5) Press the Function button and set the function.
◆ The Function button is different depending on the item to be set.
- (6) When the [↵] is pressed, the setting is fixed.
To cancel the setting, press the [✖] button.

Note

Timer can input up to 20 items per day of week. When the schedule becomes full, re-input after deleting the setting.

Note

R.C. Prohibition:

- (1) “—” (Hold) : Continues the previous setting.
“√” (Enable) : Prohibits operation from the standard remote controller.
“ ” (Disable) : Allows operation from the standard remote controller.
When the “OK” button is pressed, setting is executed.
- (2) When changing the setting, always set all the items.
- (3) When the “Hold” button is pressed, all the items are set to “—”.

Notes

- Perform the following settings:

Setting items on “Operation Setting” screen

- (1) **Operation start time or stop time:** What hour and what minute of AM or PM
- (2) **Operation setting:** “ON”, “OFF”, and “Hold*”
- (3) **Operation mode:** “Auto”, “Cool”, “Dry”, “Fan”, “Heat”, and “Hold*”
- (4) **Temperature setting:**

Heating: 10°C to 30°C, or “Hold*”

Otherwise: 18°C to 30°C, or “Hold*”

- (5) **Remote controller operation restrictions setting:**

All functions, Operation “On”, Operation “On/Off”, “Set Temp.”, Operation mode,

Timer prohibition (Timer prohibition of the standard remote controller), Filter alarm reset (Filter reset of the standard remote controller) “Hold*”

When a setting other than “Hold” was selected, perform prohibit/allow setting for each function. However, when “All” was prohibited, other settings (“On/Off”, “On”, “Mode”, “Temp”, “Timer”, and “Filter”) cannot be performed. When “On/Off” was prohibited, “On” setting cannot be performed. Therefore, when setting each function, allow “All” setting.

Notes

1 pattern is set from 00:00 to 23:59.

When you want to perform setting that spans the date, create a separate pattern or create by including a setting after 00:00.

3-3-4-4 Schedule timer Copy/Paste

Timer Setting

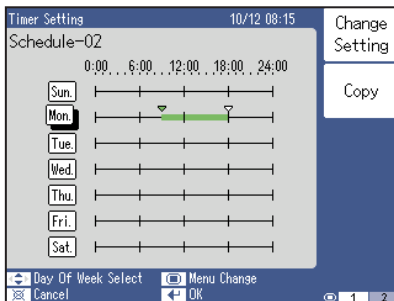

Copy a set schedule timer to another day of week.

- (1) Press the [**↔**] button and move the cursor to the day of week you want to copy.
- (2) Press the [Copy(F2)] button.

Timer Setting

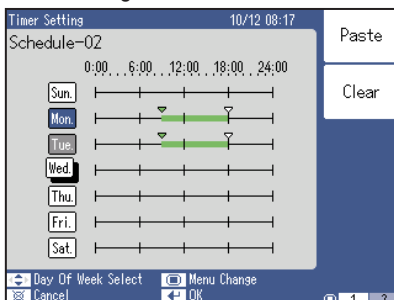

- (3) Press the [**↔**] button and move the cursor to the day of week you want to paste.
- (4) Press the [Paste (F1)] button.
 - ◆ When canceling copy, press the [Clear (F2)] button.

Timer Setting

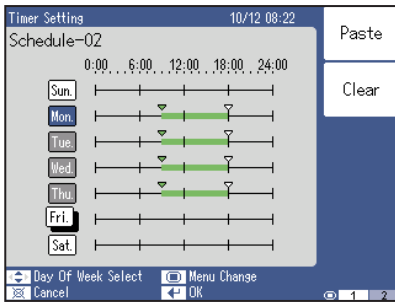

When “Sun.” data was copied to “Mon.”

- (5) When the [←] is pressed, the setting is fixed.

3-3-4-5 Setting schedule on/off

On/Off Setting

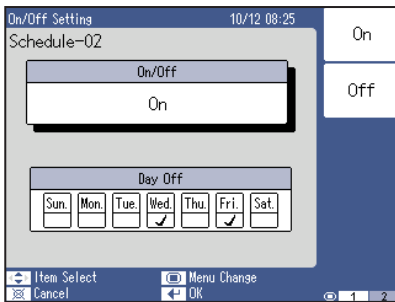

When setting schedule on/off

- (1) Press the [↔] button and move the cursor to the “On/Off” menu.
[On(F1)] button : Enables On/Off setting.
[Off(F2)] button : Disables On/Off setting.
- (2) When the [←] is pressed, the setting is fixed.
(To cancel the setting, press the [✖] button.)

Note

The schedule function is not activated for a schedule set to disable.

On/Off Setting

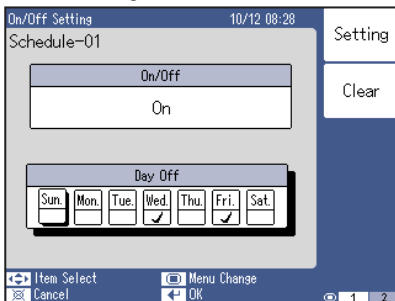

When setting Day Off

- (1) Press the [↔] button and move the cursor to the day of week you want to set.
- (2) [Setting (F1)] button : Enables Day Off.
[Clear(F2)] button : Disables Day Off.
- (3) When the [←] is pressed, the setting is fixed.
(To cancel the setting, press the [✖] button.)

Note

For the set schedule with day of week, execution is canceled only for the next day of week. It is executed from the day of week after that.

3-3-4-6 Schedule Copy/Paste

Schedule Setting

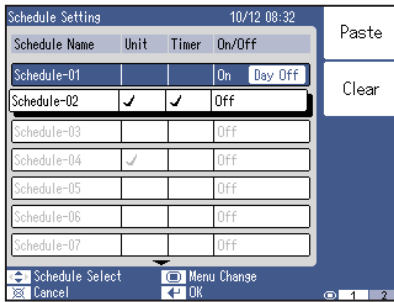

Copy a schedule.

- (1) Press the [↔] button and move the cursor to the schedule you want to copy.
- (2) Press the [Copy (F1)] button.

Schedule Setting

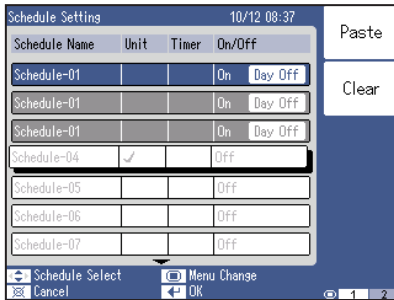

- (3) Move the cursor to the schedule you want to paste.
- (4) Press the [Paste(F1)] button.
- (5) Press the [←] button.

3-3-4-7 Schedule initialization

Schedule Setting

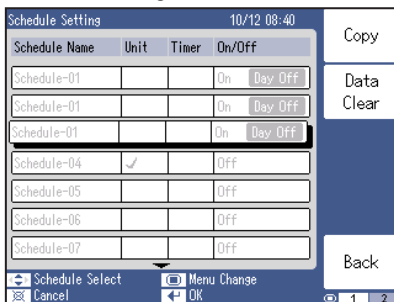

Initialize a schedule. Return to the factory setting.

- (1) Press the [↔] button and move the cursor to the schedule.
- (2) Press the [Data Clear (F2)] button.
- (3) Press the [←] button.

3-3-5 Password Setting (For manager)

Password Setting

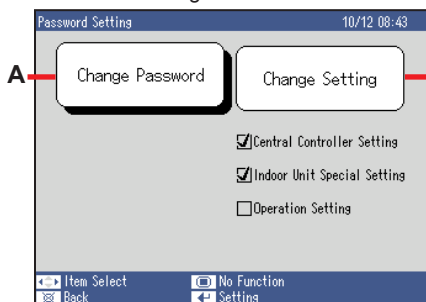

- (1) Press the [↔] button and move the cursor to the item you want to set.
 - A: Change Password
Changing the manager password (par. 3-3-5-1)
 - B: Change Setting
Managing the manager access right (par. 3-3-5-2)
- (2) Press the [←] button.
Each setting screen opens.

3-3-5-1 Changing the manager password

Password Verification

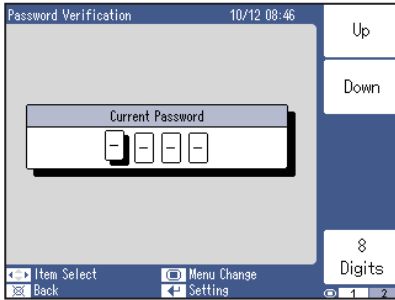

Change Password

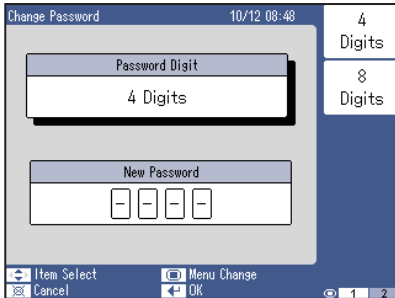

When 4-digit notation is displayed

Change the manager password.

Note

The default password is "0000" (4 digits).

- (1) Enter the password.
Press the [↔] button, [Up (F1)] button, or [Down(F2)] button.
- (2) Press the [←] button.
- (3) Move the cursor to the "Password Digit" menu.
[4 Digits (F1)] button : 4-digit mode
[8 Digits (F2)] button : 8-digit mode
- (4) Press the [↔] button to move the cursor to the "New Password" menu. And press the [↔] button and [Up (F1)] or [Down (F2)] button and set the new password.
- (5) When the [←] button is pressed, setting is complete.

Note

- If you forget the password after password change (setting) was performed, subsequent installer setting will be impossible.
- Enter the password in the password control table at the back cover of the operating manual (printed matter) so as not to forget it.
- If you forget a password, contact your local dealer.

3-3-5-2 Managing the manager access right

Password Verification

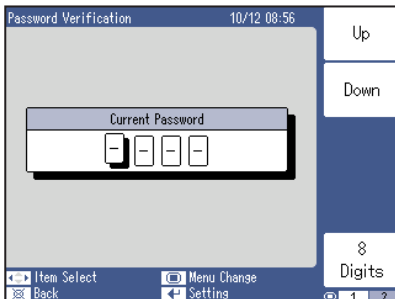

Change setting

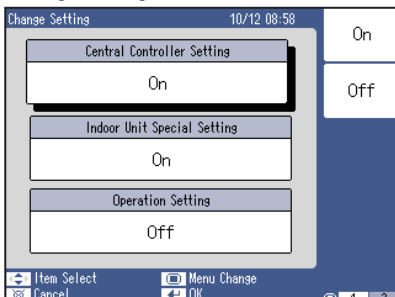

Whether or not the Password screen is displayed can be set for each setting by category to be set (Setup menu "Central Controller Setting", "Indoor Unit Special Setting", and Monitor screen "Operation Setting").

- (1) Enter the password.
Press the [↔] button and [Up (F1)] button or [Down(F2)] button.
- (2) Press the [←] button.
- (3) Press the [↔] button and move the cursor to the item you want to set.
Press the Function button and set the function.
[On (F1)] button : Set.
[Off (F2)] button : Not set
- (4) When the [←] button is pressed, setting is complete.

The kinds and relationship of passwords which can be set at this controller are as follows:

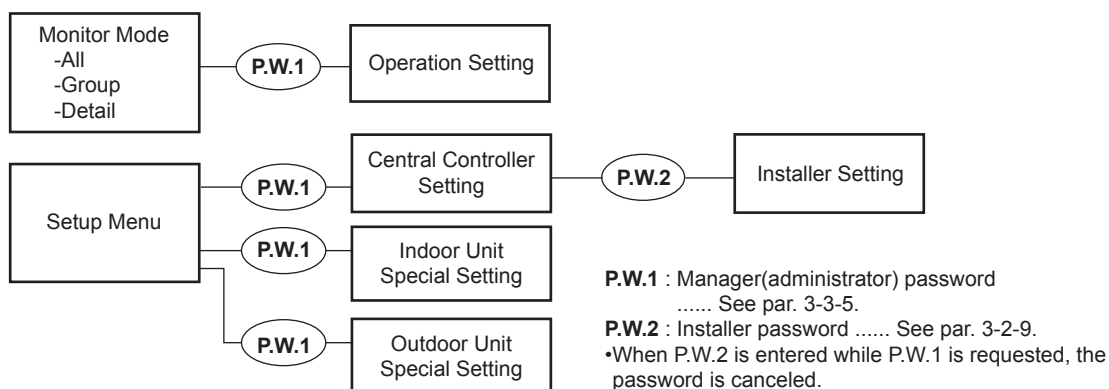

3-4 Preference Setting

3-4-1 Preference Setting screen

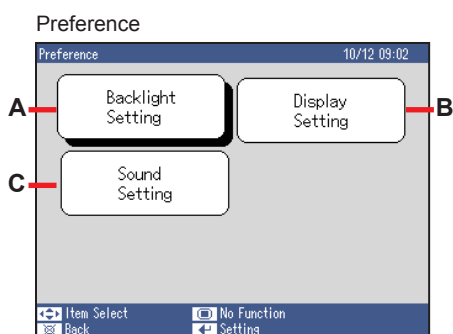

- (1) Press the [↔] button and move the cursor to the item you want to set.

A: Backlight Setting (Par. 3-4-2)
 B: Display Setting (Par. 3-4-3)
 C: Sound Setting (Par.3-4-4)

- (2) Press the [←] button.
 Each setting screen opens.

3-4-2 Backlight Setting

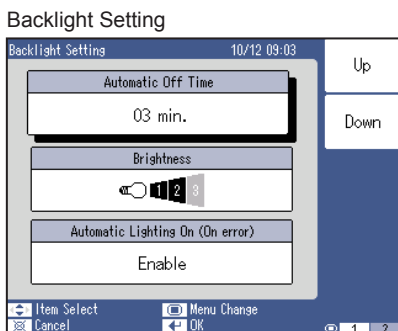

- (1) Press the [↔] button and move the cursor to the “Automatic Off Time” menu.
 [Up (F1)] button : Automatic backlight off time becomes longer.
 [Down (F2)] button : Automatic backlight off time becomes shorter.
- (2) Press the [↔] button and move the cursor to the “Brightness” menu.
 [Up (F1)] button : Screen becomes brighter.
 [Down (F2)] button : Screen becomes darker.
- (3) Press the [↔] button and move the cursor to the “Automatic Lighting On (On error)” menu.
 [Enable (F1)] button : Automatically turns on lighting when an error occurs while lighting is off.
 [Disable (F2)] button : Does not automatically turn on lighting even if an error occurs while lighting is off.
- (4) When the [←] button is pressed, setting is complete.

3-4-3 Display Setting

Display Setting

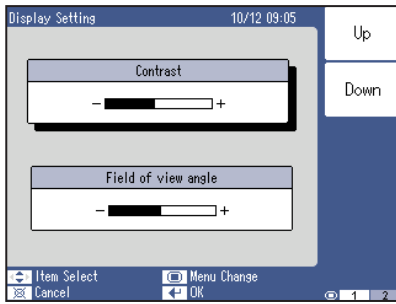

- (1) Press the [↔] button and move the cursor to the “Contrast” menu.
[Up (F1)] button : Raises the contrast level.
[Down (F2)] button : Lowers the contrast level.
- (2) Press the [↔] button and move the cursor to the “Field of View Angle” menu.
[Up (F1)] button : Raises the level of “Field of View Angle”.
[Down (F2)] button : Lowers the level of “Field of View Angle”.
- (3) When the [↵] button is pressed, setting is complete.

3-4-4 Sound Setting

Sound Setting

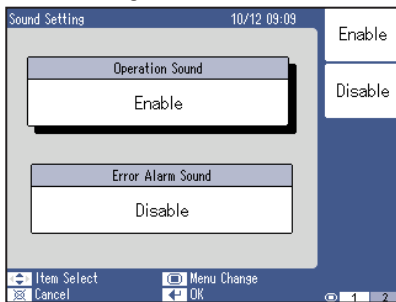

- (1) Press the [↔] button and move the cursor to the “Operation Sound” menu.
[Enable (F1)] button : Enables operation sound.
[Disable (F2)] button : Disables operation sound.
- (2) Press the [↔] button and move the cursor to the “Error Alarm Sound” menu.
[Enable (F1)] button : Outputs a beep sound when an error occurs.
[Disable (F2)] button : Does not output a beep sound when an error occurs.
- (3) When the [↵] button is pressed, setting is complete.

Note

When “Error Alarm Sound” is set to “Enable” a beep sound is output when an error occurs even if “Operation Sound” was set to Disable. The error alarm beep sound is output until there is no more error or the button is pressed.

3-5 Maintenance Setting

3-5-1 Maintenance Setting screen

Maintenance

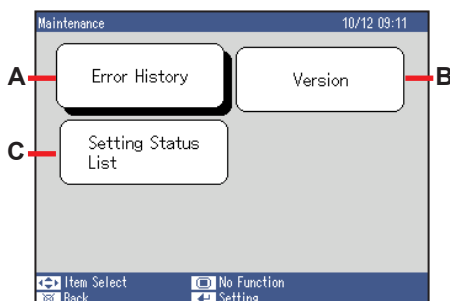

- (1) Press the [↔] button and move the cursor to the menu you want to set.
A: Error History (Par. 3-5-2)
B: Version (Par. 3-5-3)
C: Setting Status List (Par. 3-5-4)
- (2) Press the [↵] button.
Each setting screen opens.

3-5-2 Error History

Error History

No.	Date Time	Name	Address	Error Code
001	2010/10/12 04:48 PM	Controller		16.4
002	2010/10/12 03:35 PM	Controller		16.4
003	2010/10/12 02:17 PM	Controller		C2.1
004	2010/10/12 01:42 PM	Controller		16.4

▽ Scroll Down

No Function Menu Change
Back No Function

Up to 200 errors at indoor units, outdoor units, and this unit registered at the Central remote controller can be displayed.

The date and time of occurrence of the error, unit name, unit address, and error code are displayed.

- Check the Error History.
[Scroll Up (F1)] button : Scrolls up the screen.
[Scroll Down (F2)] button : Scrolls down the screen.

- Erase the Error History data.
(1) Press the [Erase All (F5)] button.
(2) When the [↵] button is pressed, erasing is complete

Note

When an error occurs at the present time, it is displayed in red.

3-5-3 Version information

Version



The version information of the central remote controller software can be verified.

When the [↵] button is pressed after verification, the display returns to the previous screen.

3-5-4 Setting Status List

Setting Status List

● Date Format	Year/Month/Day
● Time Format	12:00-11:59
● Summer time Setting	Disable
● System Clock Adjustment	Master
● Clock Adjustment Schedule	Weekly Sun. 12:00 AM

▽ Scroll Down

No Function Menu Change
Back No Function

The setting status of each setting can be verified.

- (1) [Scroll Up (F1)] button : Scrolls up the screen.
[Scroll Down (F2)] button : Scrolls down the screen.
- (2) When the [↵] button is pressed, the display returns to the previous screen.

3-6 Indoor Unit Special Setting

3-6-1 Indoor Unit Special Setting screen

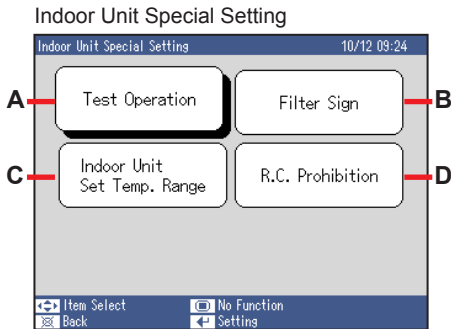

- (1) Press the [↔] button and move the cursor to the menu you want to set.

A: Test Operation (Par.3-6-2)

B: Filter Sign (Par. 3-6-3)

C: Indoor Unit Set Temp. Range (Par. 3-6-4)

D: R.C.Prohibition : (Par. 3-6-5)

- (2) Press the [←] button.
Each setting screen opens.

3-6-2 Test Operation setting

Test Operation-Group

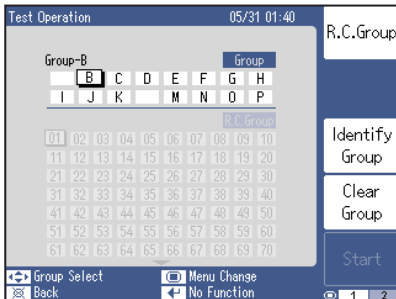

[Group(F1)]
button



[R.C.Group(F1)]
button

Test Operation-R.C.Group

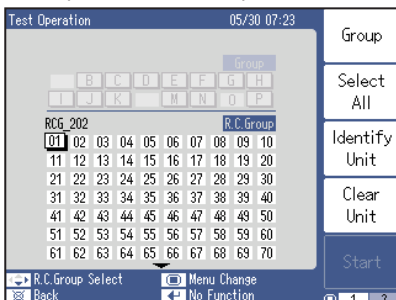

- Perform "Test Operation" in "Group" units.

- (1) Press the [↔] button and move the cursor to a Group.
- (2) [Identify Group (F3)] button : The Group to be operated is specified.
[Clear Group (F4)] button : The specified Group is cleared.
- (3) Press the [Start (F5)] button.
 - ◆ Multiple Groups can be operated simultaneously by repeating steps (1) and (2).

- Perform "Test Operation" in "R.C. Group" units.

- (1) Press the [↔] button and move the cursor to an R.C. Group.
 - ◆ When the [Select All (F2)] button is pressed, all the R.C. Groups are selected.
- (2) [Identify Unit (F3)] button : The R.C. Group to be operated is specified.
[Clear Unit (F4)] button : The specified R.C.Group is cleared.
- (3) Press the [Start (F5)] button.
 - ◆ Multiple R.C. Groups can be operated simultaneously by repeating steps (1) and (2).

Note

There are the following 2 methods of resetting test operation.

- (1) Automatic reset when 60 minutes has elapsed.
- (2) Reset when operation stop was performed.

3-6-3 Filter Sign reset

Filter Sign-Group

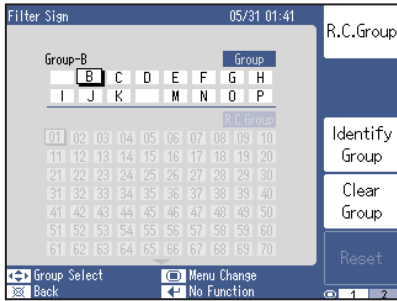

Filter Sign-R.C.Group

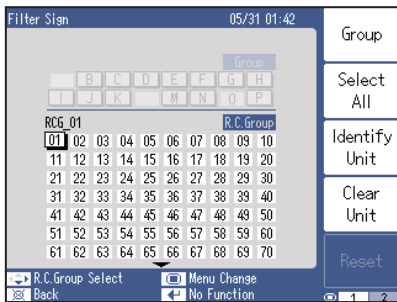

- Reset the “Filter Sign” in “Group” units.

- (1) Press the [\leftarrow \rightarrow] button and move the cursor to a Group you want to set.
- (2) [Identify Group (F3)] button : The Group to be operated is specified.
[Clear Group (F4)] button : The specified Group is cleared.
- (3) Press the [Reset (F5)] button.
 - ◆ Multiple Groups can be operated simultaneously by repeating steps (1) and (2).

- Reset the “Filter Sign” in “R.C. Group” units.

- (1) Press the [\leftarrow \rightarrow] button and move the cursor to an R.C. Group you want to set.
 - ◆ When the [Select All (F2)] button is pressed, all the R.C. Groups are selected.
- (2) [Identify Unit (F3)] button : The R.C. Group to be operated is specified.
[Clear Unit (F4)] button : The specified R.C. Group is cleared.
- (3) Press the [Reset (F5)] button.
 - ◆ Multiple R.C. Groups can be operated simultaneously by repeating steps (1) and (2).

Note

Filter Sign indicates the cleaning timing of the air clean filter set at the indoor unit. Perform “Filter sign reset” when the filter was cleaned. When the function does not exist at the objective unit, setting cannot be selected.

3-6-4 Indoor Unit Set Temp. Range Setting

Indoor Unit Set Temp. Range-Group

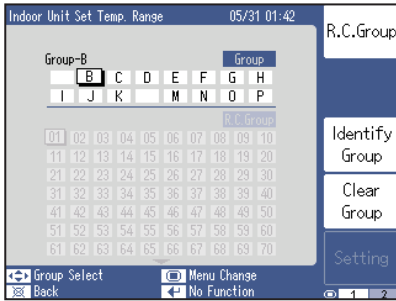

[Group(F1)]
button



[R.C.Group(F1)]
button

Indoor Unit Set Temp. Range-R.C.Group

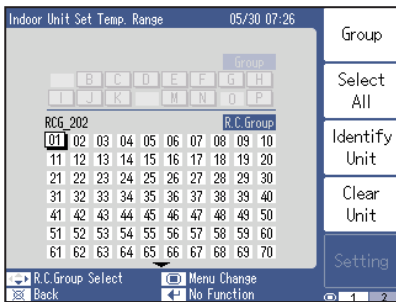

Set Temp. Range Setting

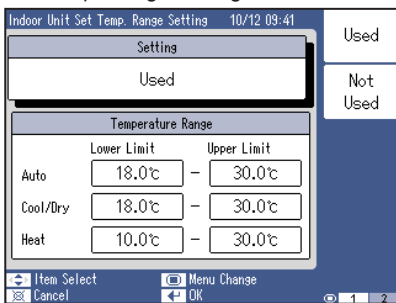

- Set the “indoor unit set temperature range” in “Group” units.

- (1) Press the [$\leftarrow \rightarrow$] button and move the cursor to a Group you want to set.
- (2) [Identify Group (F3)] button : The Group to be set is specified.
[Clear Group (F4)] button : The specified Group is cleared.
- (3) Press the [Setting (F5)] button. (Go to step (4).)
 - ◆ Multiple Groups can be set simultaneously by repeating steps (1) and (2).

- Set the “indoor unit set temperature range” in “R.C. Group” units.

- (1) Press the [$\leftarrow \rightarrow$] button and move the cursor to an R.C.Group you want to set.
 - ◆ When the [Select All (F2)] button is pressed, all the R.C. Groups are selected.
- (2) [Identify Unit (F3)] button : The R.C.Group to be set is specified.
[Clear Unit (F4)] button : The R.C. Group to be specified is cleared.
- (3) Press the [Setting (F5)] button.
 - ◆ Multiple R.C. Groups can be set simultaneously by repeating steps (1) and (2).

- (4) Press the [$\leftarrow \rightarrow$] button and move the cursor to the “Setting” menu.
[Used (F1)] button : Sets a temperature range.
[Not Used (F2)] button : Does not set a temperature range.

When set to “Used”, perform the following setting.

- (5) Press the [$\leftarrow \rightarrow$] button and move the cursor to “Temperature Range” menu you want to set.
[Up (F1)] button : Raises the limit value.
[Down (F2)] button : Lowers the limit value.
- (6) When the [\leftarrow] button is pressed, setting is complete.

Notes

- Set the upper and lower limit temperatures settings to the registered indoor unit.
*The temperature settings from the Standard Remote Controllers are restricted.
- When inappropriate setting is performed, the values are displayed in red. The displayed contents are not effective. Enter them again.
- Only lower limit or upper limit setting cannot be determined. Determine the set contents after entering both values.
- Raises/lowers the set temperature in 0.5°C steps for Celsius display and in 1°F steps for Fahrenheit display.
- The temperature range is different depending on the operation mode. The upper and lower limit of set temperature range are as follows:

Mode	Celsius (°C)	Fahrenheit (°F)
Auto,Cool, Dry	18-30	64-88
Heat	10-30	48-88

- Depending on the model of indoor unit, the settable range may be restricted. Refer to the indoor unit manual for details.

Note

Setting temperature range in Group units

When “—” is displayed at the temperature item, the set temperature of the selected indoor units does not match.

When “Setting” is set to “Used”, match each set temperature at all the indoor units.

3-6-5 R.C. Prohibition Setting

R.C. Prohibition Setting-Group

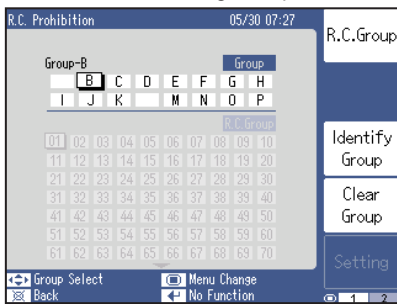

[Group(F1)]
button

[R.C.Group(F1)]
button

R.C. Prohibition Setting-R.C.Group

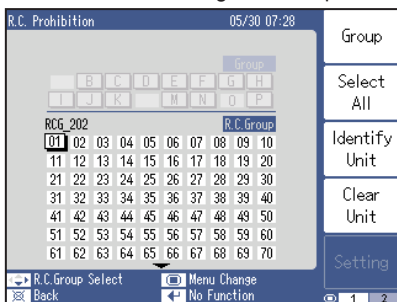

R.C.Prohibition Setting

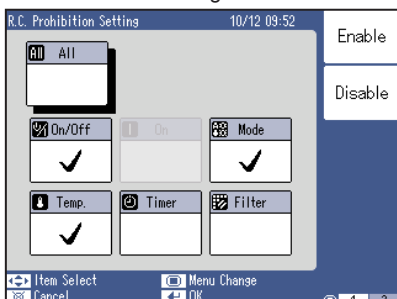

Items marked “✓” are prohibited settings. When even one “Enable / Disable” settings item does not match, “Mixed” is displayed in all the fields.

- Set the prohibition setting of the connected standard remote controller in Group units.

- Press the [] button and move the cursor to a Group you want to set.
- [Identify Group (F3)] button : The Group to be set is specified.
[Clear Group (F4)] button : The specified Group is cleared.
- Press the [Setting (F5)] button. (Go to step (4).)

- Multiple Groups can be operated simultaneously by repeating steps (1) and (2).

- Set the prohibition setting of the connected standard remote controller in R.C. Group units.

- Press the [] button and move the cursor to an R.C. Group you want to set.
 - When the [Select All (F2)] button is pressed, all the R.C. Groups are selected.
- [Identify Unit (F3)] button : The R.C.Group to be set is specified.
[Clear Unit (F4)] button : The specified R.C. Group is cleared.
- Press the [Setting (F5)] button.

- Multiple R.C. Groups can be operated simultaneously by repeating steps (1) and (2).

- Press the [] button and move the cursor to the item you want to set.
[Enable (F1)] button : Prohibits the operation from standard remote controller.
[Disable (F2)] button : Allows the operation from standard remote controller.

- When the [] button is pressed, setting is complete.

Notes

The function which can be set here has the following contents.

R.C. Prohibition	Contents
All	Operation of all control functions are enabled or disabled.
On/Off	"On/Off" operation is enabled or disabled.
On	"On" operation is enabled or disabled.
Temp.	"Temp." operation is enabled or disabled.

R.C. Prohibition	Contents
Mode	"Mode" operation is enabled or disabled.
Timer	"Timer" operation of remote controller is enabled or disabled.
Filter	"Filter" operation is enabled or disabled.

3-7 Outdoor Unit Special Setting

3-7-1 Outdoor Unit Special Setting screen

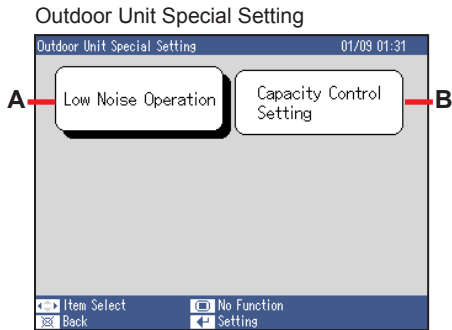

(1) Press the [↔] button and move the cursor to the item you want to set.

A: Low Noise Operation (Par. 3-7-2)

B: Capacity Control Setting (Par. 3-7-3)

(2) Press the [↵] button.

Each setting screen opens.

3-7-2 Low Noise Operation

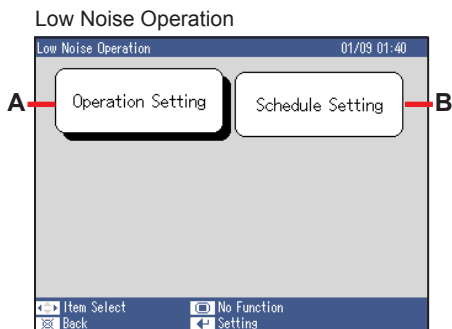

● Lower the operating sound of the outdoor unit.

(1) Press the [↔] button and move the cursor to the item you want to set.

A: Operation Setting (Par.3-7-2-1)

“Operation Setting” directly controls the Start / Stop of “Low Noise Operation” function.

B: Schedule Setting (Par. 3-7-2-2)

“Schedule Setting” controls the Start / Stop schedule of “Low Noise Operation” function.

(2) Press the [↵] button.

Each setting screen is displayed.

Note

- All outdoor units registered by this controller are set together by the “Low Noise Operation” function.
- When the “Low Noise Operation” function is set to ON, cooling or heating maximum capacity may be limited.

3-7-2-1 Operation Setting

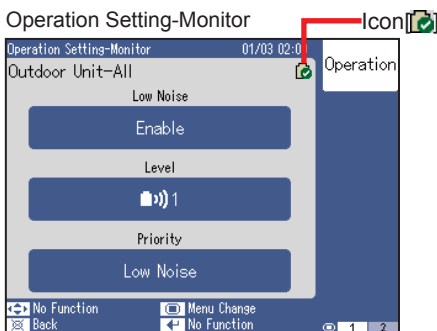

When monitor screen appears, press the [Operation (F1)] button.

Note

When the icon  is displayed, the outdoor unit setting has the priority.

Operation Setting

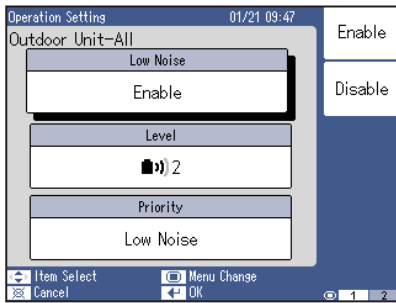

- Set “Enable” or “Disable” for “Low Noise Operation”.
- (1) Press the [↔] button and move the cursor to the “Low Noise.”
 [Enable (F1)] button: Sets the “Low Noise Operation” to “ON”.
 [Disable (F2)] button: Sets the “Low Noise Operation” to “OFF”.
 - Set the level of the operating sound for “Low Noise Operation”.
 - (2) Press the [↔] button and move the cursor to the “Level.”
 [Up (F1)] button: Raises the setting level.
 [Down (F2)] button: Lowers the setting level.
 - Level 1: The effect of decreasing the outdoor sound is small.
 - Level 2: The effect of decreasing the outdoor sound is normal.
 - Level 3(*): The effect of decreasing the outdoor sound is large.
 - (*Level 3 may not be displayed depending on the connected outdoor unit.)
 - Set the priority item for “Low Noise Operation”.
 - (3) Press the [↔] button and move the cursor to the “Priority.”
 [Low Noise (F1)] button: Gives the priority to the low noise operation.
 [Performance (F2)] button: Gives the priority to the performance operation.
 - (4) When the [←] button is pressed, setting is complete.

Note

When outdoor units with 2 setting levels and outdoor units with 3 setting levels are mixed in all outdoor units registered by this controller, the menu screen in which 3 setting levels can be set is displayed. In this case, even if the outdoor unit with 2 setting levels is set to Level 3, the actual setting will be Level 2.

3-7-2-2 Low Noise Operation Schedule Setting

Schedule Setting

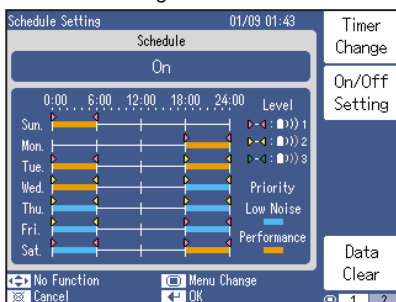

- Set the “Low Noise Operation” schedule.
- [Timer Change (F1)]: Sets timer. (Par. 3-7-2-2-1)
 - [On/Off Setting (F2)]: Sets the timer On/Off. (Par. 3-7-2-2-2)
 - [Data Clear (F5)]: Deletes the set timer.

3-7-2-2-1 Timer Change

Timer Change

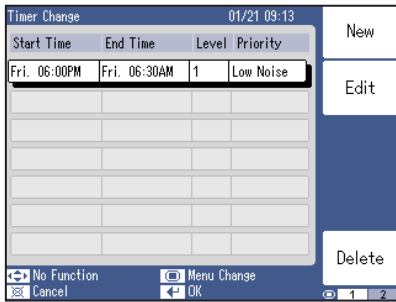

Operation Setting

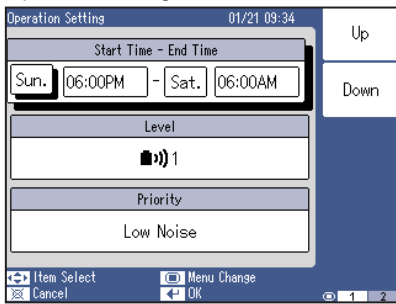

- Enter each setting item of timer.
 - When registering newly, press the [New (F1)].
 - When changing the registered contents, press the [Edit (F2)].
 - When deleting the timer, press the [Delete (F5)].

- (1) Press the [↔] button and move the cursor to the item you want to set. Press the function button to set.
 - “Low Noise Operation” Start Time (day of the week and time) and End Time (day of the week and time)
 - Level of decreasing the outdoor sound
 - Priority operation
- (2) When setting is complete, press the [←] button.

Note

When timer setting is complete, if “On/Off” setting item is set to “ON”, the operation starts according to the set schedule.

3-7-2-2-2 On/Off Setting

On/Off Setting

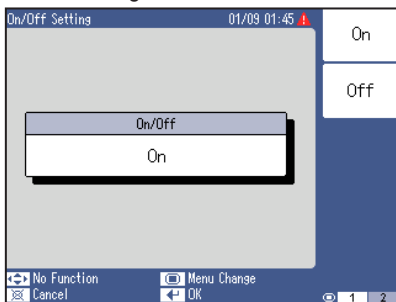

- Set the set timer On/Off.
- (1) Select the following items and press the function button.
 - [On (F1)]: Sets the schedule “On.”
 - [Off (F2)]: Sets the schedule “Off”.
 - (2) When setting is complete, press the [←] button.

3-7-3 Capacity Control Setting

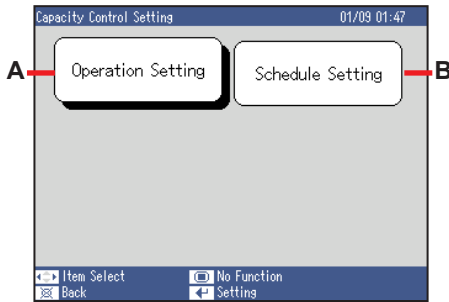

- Limit the operation capacity and perform the energy saving operation.

(1) Press the [↔] button and move the cursor to the item you want to set.

A: Operation Setting (Par: 3-7-3-1)

“Operation Setting” directly controls the Start / Stop of “Capacity Control Setting” function.

B: Schedule Setting (Par: 3-7-3-2)

“Schedule Setting” controls the Start / Stop schedule of “Capacity Control Setting” function.

(2) Press the [←] button.
Each setting screen is displayed.

Note

- All outdoor units registered by this controller are set together by the “Capacity Control Setting” function.
- When the “Capacity Control Setting” function is set to ON, cooling or heating maximum capacity may be limited.

3-7-3-1 Operation Setting

Operation Setting

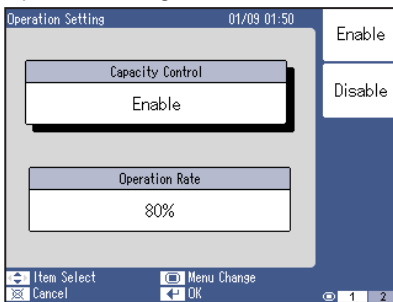

- Set “Enable” or “Disable” for “Capacity Control Setting”.

(1) Press the [↔] button and move the cursor to the “Capacity Control.”

[Enable (F1)] button: Sets the “Capacity Control Setting” to “ON”.

[Disable (F2)] button: Sets the “Capacity Control Setting” to “OFF”.

- Set the “Operation Rate”.

(2) Press the [↔] button and move the cursor to the “Operation Rate”

[Up (F1)] button: Raises the setting level.

[Down (F2)] button: Lowers the setting level.

(3) When the [←] button is pressed, setting is complete.

3-7-3-2 Schedule Setting

Schedule Setting

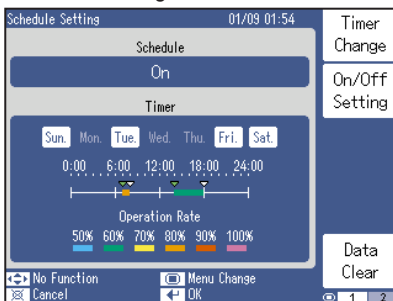

- Set the “Capacity Control Setting” schedule.

[Timer Change (F1)]: Sets the timer. (Par: 3-7-3-2-1)

[On/Off Setting (F2)]: Sets the timer On/Off. (Par: 3-7-3-2-2)

[Data Clear (F5)]: Deletes the set timer.

3-7-3-2-1 Timer Change

Timer Change

Start Time	End Time	Operation Rate
07:00 AM	08:00 AM	80%
02:00 PM	06:00 PM	60%



Timer Change



Operation Setting

- Set the day of week.
Press the [↔] button and select the “Day of week” you want to set.
[Setting (F1)]: Enables the setting.
[Clear (F2)]: Clears the setting.

- Set the Start Time, End Time, and Operation Rate of “Capacity Control Setting”.
Press the [↔] button and move the cursor to the “Timer.”
 - When entering newly, press the [New (F1)] button.
 - When editing the entered data, press the [↔] button and move the cursor to the “Timer” to be edited and press [Edit (F2)] button.
 - When deleting the timer, press the [Delete (F5)].

- (1) Press the [↔] button and move the cursor to the item you want to set. Press the function button to set.
 - Start Time and End Time of “Capacity Control”
 - Operation Rate
- (2) When setting is complete, press the [←] button.

3-7-3-2-2 On/Off Setting

On/Off Setting

- Set the set timer on/off.

Press the function button and select the following items:
[On (F1)]: Sets the “Capacity Control Setting” to “ON”.
[Off (F2)]: Sets the “Capacity Control Setting” to “OFF”.

Note

When timer setting is complete, if “On/Off” setting item is set to “ON”, the operation starts according to the set schedule.

4 OTHERS

4-1 Outline dimensions

(1) Control unit

Unit:mm (in.)

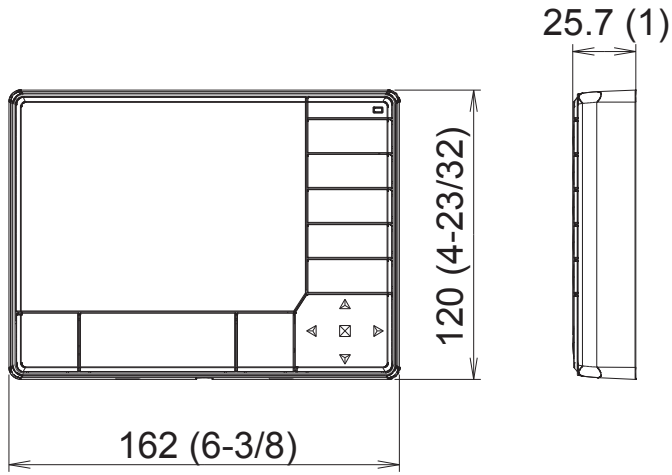

(2) Power supply unit

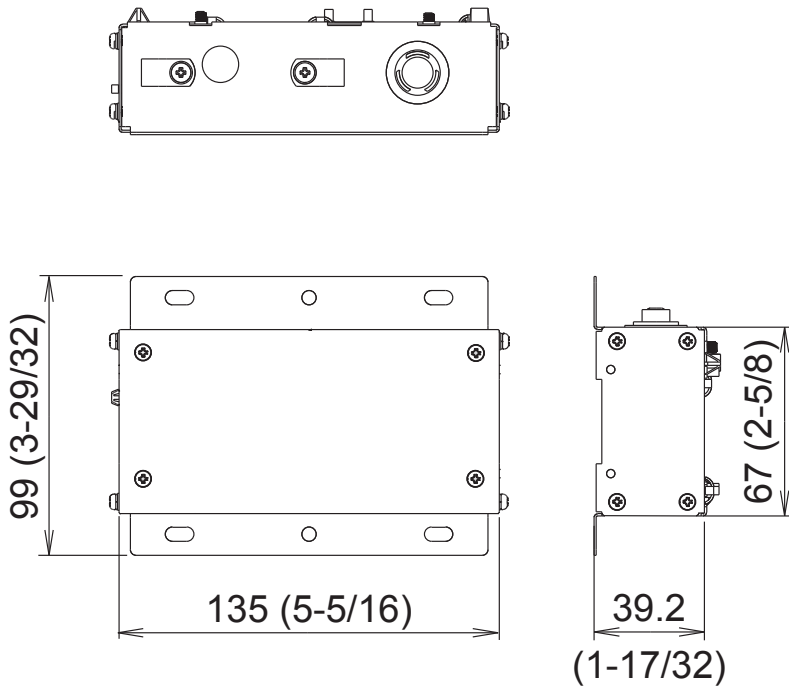

4-2 Specifications

Model name		UTY-DCGY, UTY-DCGG	
Power source voltage	V	1 ∅ AC100 - 240	
Power source frequency	Hz	50 / 60	
Power consumption	W	3	
Display		Color TFT LCD, 5.0 inch QVGA	
External interface		Transmission line	
		External input	
		External output	
Usage temperature range	°C (°F)	0 to 40 (32 to 104)	
Usage humidity range	%	0 to 85 (no condensation)	
Storage temperature range	°C (°F)	-20 to 70 (-4 to 158)	
Storage humidity range	%	0 to 85 (no condensation)	
Dimensions (H×W×D)	Control unit	mm (in.)	120×162×25.7 (4-23/32 × 6-3/8 × 1)
	Power supply unit		99×135×39.2 (3-29/32 × 5-5/16 × 1-17/32)
Weight	Control unit	g (oz.)	308 (10.9)
	Power supply unit		355 (12.6)

* The liquid crystal panel is manufactured using high precision technology, but there may be 0.01% or less mixing pixels or continuously lighted pixels. This is not a trouble.

4-3 Error code

- For the details of the indoor unit or outdoor unit error when checking the error contents, refer to the error codes in each installation manual.

Error code	Contents
161	Peripheral unit transmission PCB connection error
164	Communication error between controller and indoor unit
C11	Peripheral unit main PCB error
C21	Peripheral unit transmission PCB error

FUJITSU GENERAL LIMITED

1116, Suenaga, Takatsu-ku, Kawasaki 213-8502, Japan