

# FUJITSU

## OPERATING MANUAL

### INVERTER

#### ROOM AIR CONDITIONER COMPACT WALL MOUNTED TYPE

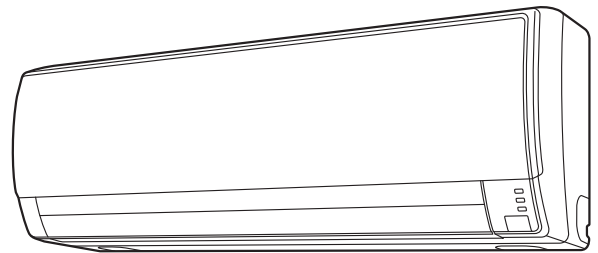

#### Indoor Unit

**ASTG09JECA**  
**ASTG12JECA**

#### Outdoor Unit

**AOTG09JEC**  
**AOTG12JEC**

KEEP THIS OPERATION MANUAL  
FOR FUTURE REFERENCE

**⚠ CAUTION**

**R410A  
REFRIGERANT**

This Air Conditioner contains and  
operates with refrigerant R410A.

THIS PRODUCT MUST ONLY BE INSTALLED OR SERVICED  
BY QUALIFIED PERSONNEL.



Refer to Commonwealth, State, Territory and local legislation,  
regulations, codes, installation & operation manuals, before  
the installation, maintenance and/or service of this product.

# CONTENTS

SAFETY PRECAUTIONS.....	2	SWING OPERATION .....	12
FEATURES AND FUNCTIONS .....	3	ECONOMY OPERATION .....	12
NAME OF PARTS .....	4	MANUAL AUTO OPERATION .....	13
PREPARATION .....	6	OPERATING TIPS.....	13
OPERATION.....	7	CLEANING AND CARE.....	14
TIMER OPERATION .....	9	TROUBLESHOOTING .....	16
SLEEP TIMER OPERATION.....	10		
ADJUSTING THE DIRECTION OF AIR CIRCULATION .....	11		

## SAFETY PRECAUTIONS

- Before using the appliance, read these “PRECAUTIONS” thoroughly and operate in the correct way.
- The instructions in this section all relate to safety; be sure to maintain safe operating conditions.
- “DANGER”, “WARNING” and “CAUTION” have the following meanings in these instructions:

 <b>DANGER</b>	This mark indicates procedures which, if improperly performed, are most likely to result in the death or serious injury to the user or service personnel.
 <b>WARNING</b>	This mark indicates procedures which, if improperly performed, might lead to the death or serious injury of the user or service personnel.
 <b>CAUTION</b>	This mark indicates procedures which, if improperly performed, might possibly result in personal harm to the user, or damage to property.

### **DANGER**

- Do not attempt to install this air conditioner by yourself.
- This air conditioner contains no user-serviceable parts. Always consult authorized service personnel for repairs.
- When moving, consult authorized service personnel for disconnection and installation of the air conditioner.
- Do not become excessively chilled by staying for many hours in the direct cooling airflow.
- Do not insert fingers or objects into the outlet port or intake grille.
- Do not start and stop air conditioner operation by disconnecting the power supply cord.
- Take care not to damage the power supply cord.
- If the power supply cord of this appliance is damaged, it should only be replaced by the authorized service personal, since special purpose tools and specified cord are required.
- In the event of a malfunction (burning smell, etc.), immediately stop operation, turn off the breaker, and consult authorized service personnel.
- In the event of refrigerant leakage, be sure to keep away from fire or any flammables. (consult an authorized service personnel)

### **CAUTION**

- Provide occasional ventilation during use.
- Do not direct airflow at fireplaces or heating apparatus.
- Do not climb on, or place objects on, the air conditioner.
- Do not hang objects from the indoor unit.
- Do not set flower vases or water containers on top of air conditioners.
- Do not place any other electrical products or household belongings under indoor unit or outdoor unit. Dripping condensation from the unit might get them wet, and may cause damage or malfunction of your property.
- Do not expose the air conditioner directly to water.
- Do not operate the air conditioner with wet hands.
- Do not pull power supply cord.
- Turn off power supply when not using the indoor unit for extended periods.
- Check the condition of the installation stand for damage.
- Do not place animals or plants in the direct path of the airflow.
- Do not drink the water drained from the air conditioner.
- Do not use in applications involving the storage of foods, plants or animals, precision equipment, or art works.
- Do not touch the aluminum fins of heat exchanger built-in the indoor or outdoor unit to avoid personal injury when you install or maintain the unit.

# SAFETY PRECAUTIONS



## CAUTION

- Do not apply any heavy pressure to radiator fins.
- Operate only with air filters installed.
- Do not block or cover the intake grille and outlet port.
- Ensure that any electronic equipment is at least 3.3ft (1m) away from either the indoor or outdoor units.
- Avoid installing the air conditioner near a fireplace or other heating apparatus.
- When installing the indoor and outdoor unit, take precautions to prevent access to infants.
- Do not use inflammable gases near the air conditioner.
- This appliance is not intended for use by persons (including children) with reduced physical, sensory or mental capabilities, or lack of experience and knowledge, unless they have been given supervision or instruction concerning use of the appliance by a person responsible for their safety. Children should be supervised to ensure that they do not play with the appliance.

# FEATURES AND FUNCTIONS

## ■ Energy saving and Comfortable function

### INVERTER

At the start of operation, large amount of power is used to bring the room quickly to the desired temperature. Afterward, the air conditioner automatically switches to a low power setting for economic and comfortable operation.

### ECONOMY OPERATION

When ECONOMY operation mode is operated, the room temperature will be little higher than the set-temp under cooling mode. Therefore, the ECONOMY mode is able to save more energy than other normal mode.

### SWING OPERATION

The Airflow Direction Louvers swings automatically up and down so that the air speeds to every nook and corner of your room.

### AUTO CHANGEOVER

The operation mode (cooling and dry) is switched automatically to maintain the set temperature, and the temperature is kept constant at all times.

### SUPER QUIET OPERATION

The indoor unit's airflow is reduced to produce quieter operation.

## ■ Convenient function

### PROGRAM TIMER

The program timer allows you to integrate OFF timer and ON timer operations in a single sequence. The sequence can involve 1 transition from OFF timer to ON timer, or from ON timer to OFF timer, within a 24 hour period.

### SLEEP TIMER

When the SLEEP button is pressed during cooling mode, the temperature setting is gradually raised during the period of operation. When the set time is reached, the indoor unit automatically turns off.

## ■ Clean function

### REMOVABLE INTAKE GRILLE

The indoor unit's Intake Grille can be removed for easy cleaning and maintenance.

### MILDEW-RESISTANT FILTER

The Air Filter has been treated to resist mildew growth, thus allowing cleaner use and easier care.

### POLYPHENOL CATECHIN AIR CLEANING FILTER

The Polyphenol Catechin Air Cleaning filter uses static electricity to clean fine particles and dust in the air such as tobacco smoke and plant pollen that are too small to see. The filter contains catechin, which is highly effective against various bacteria by suppressing the growth of the bacteria adsorbed to the filter.

Note that when the Air Cleaning Filter is installed, the amount of air produced decreases, causing a slight decrease in the indoor unit's performance.

### NEGATIVE AIR IONS DEODORIZING FILTER

It comprises pottery super micro particles which can produce negative air ions having the effect of deodorizing and can absorb and remit the peculiar smell at home.

## ■ Remote controller

### WIRELESS REMOTE CONTROLLER

The Wireless Remote Controller allows convenient control of indoor unit operation.

# NAME OF PARTS

Fig. 1

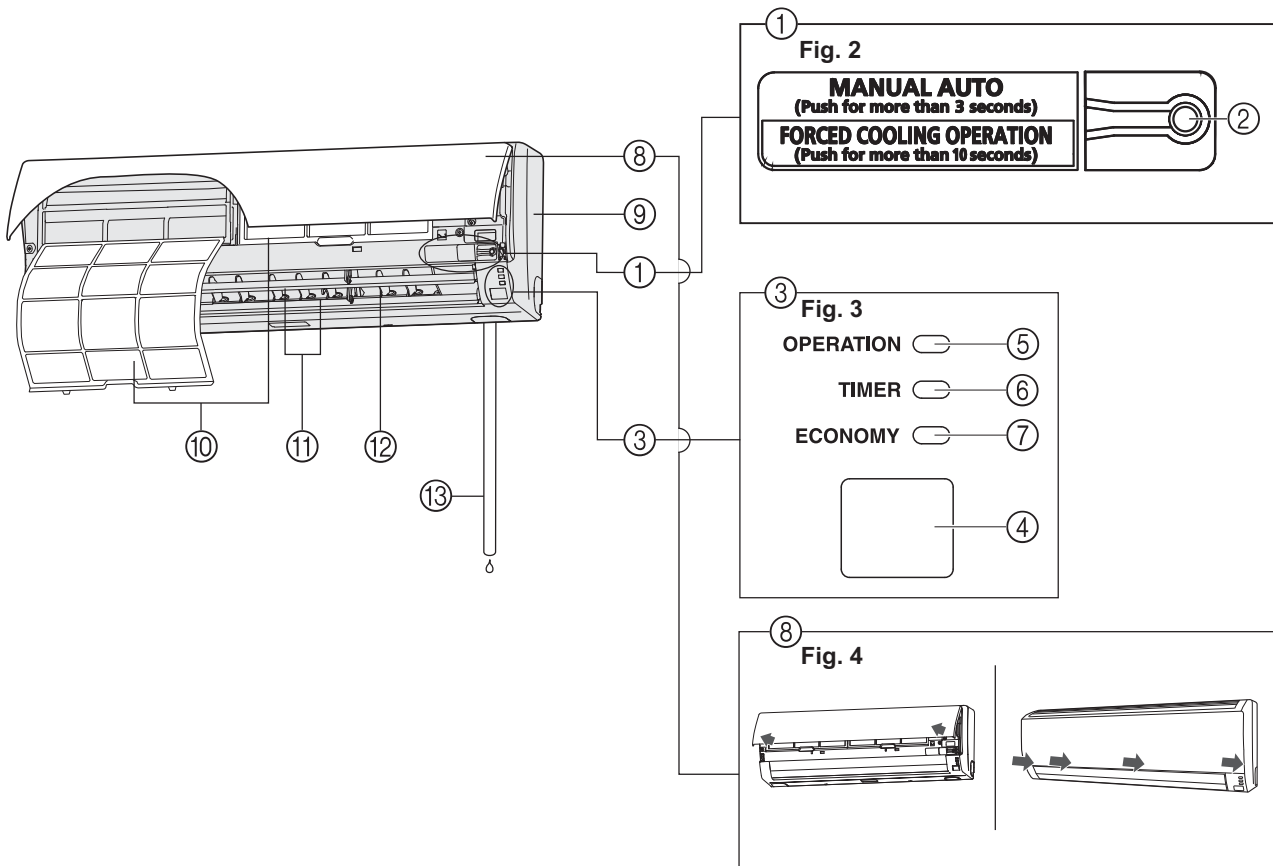

Fig. 5

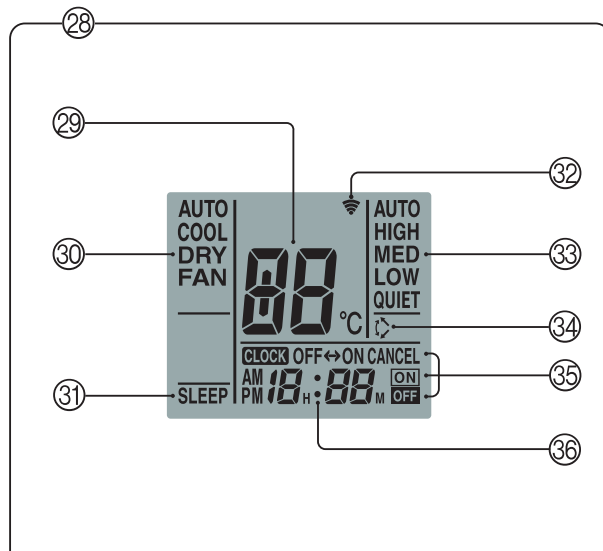
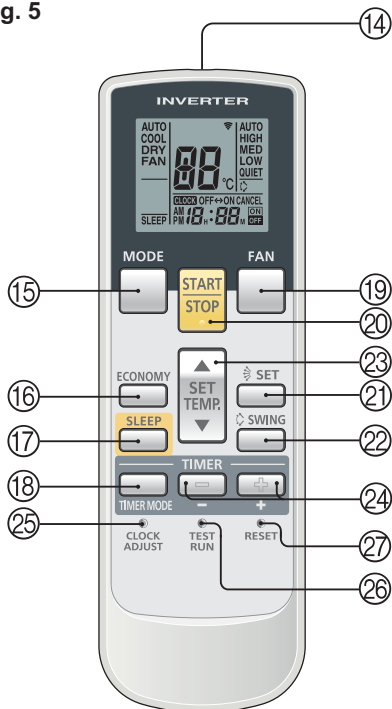

Fig. 6

To facilitate explanation, the accompanying illustration has been drawn to show all possible indicators; in actual operation, however, the display will only show those indicators appropriate to the current operation.

# NAME OF PARTS

**Fig. 1 Indoor Unit**

① **Operating Control Panel (Fig. 2)**

② **MANUAL AUTO button**

- When the MANUAL AUTO button is pressed in for more than 10 seconds, the forced cooling operation will start.
- The forced cooling operation is used at the time of installation.  
Only for authorized service personnel's use.
- When the forced cooling operation starts by any chance, press the START/STOP button to stop the operation.
- Please press the button at FILTER INDICATOR RESET

③ **Indicator (Fig. 3)**

④ **Remote Control Signal Receiver**

⑤ **OPERATION Indicator Lamp (green)**

⑥ **TIMER Indicator Lamp (orange)**

- If the TIMER indicator lamp flashes when the timer is operating, it indicates that a fault has occurred with the timer setting (See page 13 "AUTO Restart.")

⑦ **ECONOMY Indicator Lamp (green)**

- ECONOMY indicator lamp lights when ECONOMY OPERATION is operating.

⑧ **Intake Grille (Fig. 4)**

⑨ **Front Panel**

⑩ **Air Filter**

⑪ **Airflow Direction Louver**

⑫ **Right-Left Louver  
(behind Airflow Direction Louver)**

⑬ **Drain Hose**

**Fig. 5 Remote Controller**

⑭ **Signal Transmitter**

⑮ **MODE button**

⑯ **ECONOMY button**

⑰ **SLEEP button**

⑱ **TIMER MODE button**

⑲ **FAN button**

⑳ **START/STOP button**

㉑ **SET button (Vertical)**

㉒ **SWING button**

㉓ **SET TEMP. button (▲ / ▼)**

㉔ **TIMER SET ( + / - ) button**

㉕ **CLOCK ADJUST button**

㉖ **TEST RUN button**

- This button is used when installing the air conditioner, and should not be used under normal conditions, as it will cause the indoor unit's thermostat function to operate incorrectly.
- If this button is pressed during normal operation, the indoor unit will switch to test operation mode, and the Indoor Unit's OPERATION Indicator Lamp and TIMER Indicator Lamp will begin to flash simultaneously.
- To stop the test operation mode, press the START/STOP button to stop the air conditioner.

㉗ **RESET button**

㉘ **Remote Controller Display (Fig.6)**

㉙ **Temperature SET Display**

㉚ **Operation Mode Display**

㉛ **SLEEP TIMER Display**

㉜ **Transmit Indicator**

㉝ **Fan Speed Display**

㉞ **SWING Display**

㉟ **Timer Mode Display**

㊱ **Clock Display**

# PREPARATION

## Turn on the Power

### 1 Turn on the circuit breaker

## Load Batteries (AAA/R03/LR03 × 2)

### 1 Press and slide the battery compartment lid on the reverse side to open it.

Slide in the direction of the arrow while pressing the  mark.

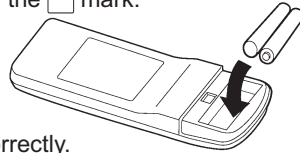

### 2 Insert batteries.

Be sure to align the battery polarities ( $\oplus/\ominus$ ) correctly.

### 3 Close the battery compartment lid.

## Set the Current time

### 1 Press the CLOCK ADJUST button (Fig. 5 ㉔).

Use the tip of a ball-point pen or other small object to press the button.

### 2 Use the TIMER SET ( $\oplus$ / $\ominus$ ) buttons (Fig. 5 ㉔) to adjust the clock to the current time.

$\oplus$  button: Press to advance the time.

$\ominus$  button: Press to reverse the time.

(Each time the buttons are pressed, the time will be advanced/reversed in 1-minute increments; hold the buttons depressed to change the time quickly in 10-minute increments.)

### 3 Press the CLOCK ADJUST button (Fig. 5 ㉔) again.

This completes the time setting and starts the clock.

## ⚠ CAUTION

- Take care to prevent infants from accidentally swallowing batteries.
- When not using the Remote Controller for an extended period, remove the batteries to avoid possible leakage and damage to the unit.
- If leaking battery fluid comes in contact with your skin, eyes, or mouth, immediately wash with copious amounts of water, and consult your physician.
- Dead batteries should be removed immediately and disposed of properly, either in a battery collection receptacle or to the appropriate authority.
- Do not attempt to recharge dry batteries.

Never mix new and used batteries, or batteries of different types. Batteries should last about 1 year under normal use. If the Remote Controller's operating range becomes appreciably reduced, replace the batteries and press the RESET button with the tip of a ball-point pen or other small object.

## To Use the Remote Controller

- The Remote Controller must be pointed at signal receiver (Fig. 3 ㉔) to operate correctly.
- Operating Range: About 7 m.
- When a signal is properly received by the indoor unit, a beeping sound will be heard.
- If no beep is heard, press the Remote Controller button again.

## Remote Controller Holder

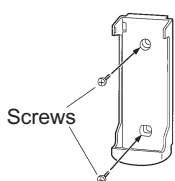

1 Mount the Holder.

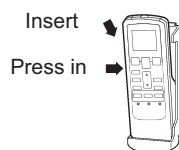

2 Set the Remote Controller.

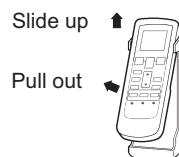

3 To remove the Remote Controller (when use at hand).

# OPERATION

## To Select Mode Operation

### 1 Press the **START/STOP** button (Fig.5 ⑳).

The indoor unit's OPERATION Indicator Lamp (green) (Fig. 3 ⑤) will light.  
The air conditioner will start operating.

### 2 Press the **MODE** button (Fig.5 ⑮) to select the desired mode.

Each time the button is pressed, the mode will change in the following order.

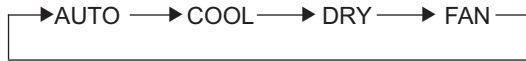

About 3 seconds later, the entire display will reappear.

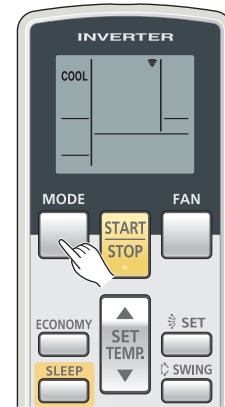

Example: When set to COOL.

## To Set the Thermostat

### Press the **SET TEMP.** button (Fig. 5 ㉓).

- ▲ button: Press to raise the thermostat setting.
- ▼ button: Press to lower the thermostat setting.

#### Thermostat setting range:

AUTO .....18–30 °C  
Cooling/Dry .....18–30 °C

The thermostat cannot be used to set room temperature during the FAN mode (the temperature will not appear on the Remote Controller's Display).

About 3 seconds later, the entire display will reappear.



Example: When set to 26 °C.

The thermostat setting should be considered a standard value, and may differ somewhat from the actual room temperature.

## To Set the Fan Speed

### Press the **FAN** button (Fig. 5 ⑲).

Each time the button is pressed, the fan speed changes in the following order:



About 3 seconds later, the entire display will reappear.

#### When set to AUTO:

- Cooling:** As the room temperature approaches that of the thermostat setting, the fan speed becomes slower.
- Fan :** The fan runs at the low fan speed.

The fan will operate at a very low setting during Monitor operation.

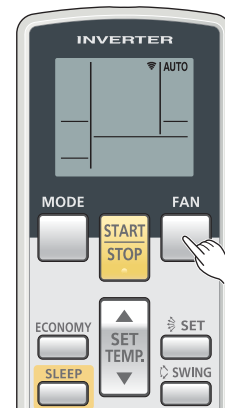

Example: When set to AUTO.

## SUPER QUIET Operation

SUPER QUIET operation begins. The indoor unit's airflow will be reduced for quieter operation.

- SUPER QUIET operation cannot be used during Dry mode. (The same is true when dry mode is selected during AUTO mode operation.)
- During Super Quiet operation, Cooling performance will be reduced somewhat. If the room does not cool down when using SUPER QUIET Operation, please adjust the indoor unit's Fan Speed.

## To Stop Operation

### Press the **START/STOP** button (Fig. 5 ⑳).

The OPERATION Indicator Lamp (green) (Fig. 3 ⑤) will go out.

# OPERATION

## About AUTO CHANGEOVER Operation

**AUTO:** ● When AUTO CHANGEOVER operation first selected, the fan will operate at very low speed for about a few minutes, during which time the indoor unit detects the room conditions and selects the proper mode.

Room temperature is higher than the defined temperature in temperature setting → Cooling mode or dry mode

Room temperature is close to or lower than the defined temperature in temperature setting → Monitor operation

- When the indoor unit has adjusted your room's temperature to near the temperature setting, it will begin monitor operation. In the monitor operation mode, the fan will operate at low speed. If the room temperature subsequently changes, the indoor unit will once again select the appropriate operation (Cooling) to adjust the temperature to the value set in the temperature setting.
- If the mode automatically selected by the unit is not what you wish, select one of the mode operation (COOL, DRY, FAN).

## About Mode Operation

**Cooling:** ● Use to cool your room.

- Dry:**
- Use for gently cooling while dehumidifying your room.
  - During Dry mode, the indoor unit will operate at low speed; in order to adjust room humidity, the indoor unit's fan may stop from time to time. Also, the fan may operate at very low speed when adjusting room humidity.
  - The fan speed cannot be changed manually when Dry mode has been selected.

**Fan:** ● Use to circulate the air throughout your room.

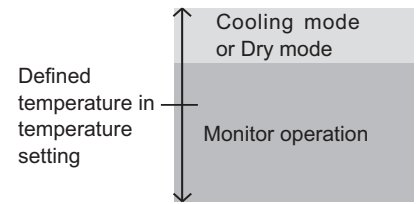

### During Cooling/Dry mode:

Set the thermostat to a temperature setting that is lower than the present room temperature. The Cooling and Dry modes will not operate if the thermostat is set higher than the actual room temperature (in Cooling mode, the fan alone will operate).

### During Fan mode:

You can not use the indoor unit to cool your room.



# TIMER OPERATION

Before using the timer function, be sure that the Remote Controller is set to the correct current time (P. 5).

## To Use the ON timer or OFF timer

**1 Press the START/STOP button (Fig. 5 ⑳)**  
(if the indoor unit is already operating, proceed to step 2).  
The indoor unit's OPERATION Indicator Lamp (green) (Fig. 3 ⑤) will light.

**2 Press the TIMER MODE button (Fig. 5 ⑱) to select the OFF timer or ON timer operation.**

Each time the button is pressed the timer function changes in the following order:

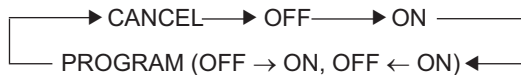

The indoor unit's TIMER Indicator Lamp (orange) (Fig. 3 ⑥) will light.

**3 Use the TIMER SET buttons (Fig. 5 ㉔) to set the desired OFF time or ON time.**

Set the time while the time display is flashing (the flashing will continue for about 5 seconds).

**+ button:** Press to advance the time.

**- button:** Press to reverse the time.

About 5 seconds later, the entire display will reappear.

### To Cancel the Timer

Use the TIMER button to select "CANCEL".  
The indoor unit will return to normal operation.

### To Change the Timer Settings

Perform steps 2 and 3.

### To Stop Air Conditioner Operation while the Timer is Operating

Press the START/STOP button.

### To Change Operating Conditions

If you wish to change operating conditions (Mode, Fan Speed, Thermostat Setting, SUPER QUIET mode), after making the timer setting and waiting until the entire display reappears, then press the appropriate buttons to change the operating condition desired.

## To Use the Program timer

**1 Press the START/STOP button (Fig. 5 ⑳)**  
(if the indoor unit is already operating, proceed to step 2).  
The indoor unit's OPERATION Indicator Lamp (green) (Fig. 3 ⑤) will light.

**2 Set the desired times for OFF timer and ON timer.**  
See the section "To Use the ON timer or OFF timer" to set the desired mode and times.  
About 3 seconds later, the entire display will reappear.  
The indoor unit's TIMER Indicator Lamp (orange) (Fig. 3 ⑥) will light.

**3 Press the TIMER MODE button (Fig. 5 ⑱) to select the PROGRAM timer operation (OFF → ON or OFF ← ON will display).**

The display will alternately show "OFF timer" and "ON timer", then change to show the time setting for the operation to occur first.

- The program timer will begin operation. (If the ON timer has been selected to operate first, the indoor unit will stop operating at this point.)

About 5 seconds later, the entire display will reappear.

### To Cancel the Timer

Use the TIMER MODE button to select "CANCEL".  
The air conditioner will return to normal operation.

### To Change the Timer Settings

1. Follow the instructions given in the section "To Use the ON Timer or OFF Timer" to select the timer setting you wish to change.
2. Press the TIMER MODE button to select either OFF → ON or OFF ← ON.

### To Stop Air Conditioner Operation while the Timer is Operating

Press the START/STOP button.

### To Change Operating Conditions

If you wish to change operating conditions (Mode, Fan Speed, Thermostat Setting, SUPER QUIET mode), after making the timer setting and waiting until the entire display reappears, then press the appropriate buttons to change the operating condition desired.

## About the Program timer

- The program timer allows you to integrate OFF timer and ON timer operations in a single sequence. The sequence can involve 1 transition from OFF timer to ON timer, or from ON timer to OFF timer, within a 24 hour period.
- The first timer function to operate will be the 1 set nearest to the current time. The order of operation is indicated by the arrow in the Remote Controller's Display (OFF → ON, or OFF ← ON).
- One example of Program timer use might be to have the air conditioner automatically stop (OFF timer) the operation after you go to sleep, then start (ON timer) the operation automatically in the morning before you arise.

# SLEEP TIMER OPERATION

Unlike other timer functions, the SLEEP timer is used to set the length of time until air conditioner operation is stopped.

## To Use the SLEEP Timer

**While the air conditioner is operating or stopped, press the SLEEP button (Fig. 5 ⑰).**

The indoor unit's OPERATION Indicator Lamp (green) (Fig. 3 ⑤) lights and the TIMER Indicator Lamp (orange) (Fig. 3 ⑥) light.

## To Cancel the Timer:

Use the TIMER MODE button to select "CANCEL".  
The air conditioner will return to normal operation.

## To Change the Timer Settings

**Press the SLEEP button (Fig. 5 ⑰) once again and set the time using the TIMER SET (  $\oplus$  /  $\ominus$  ) buttons (Fig. 5 ⑳).**

Set the time while the Timer Mode Display is flashing (the flashing will continue about 5 seconds).

## To Stop the Air Conditioner During Timer Operation:

Press the START/STOP button.

$\oplus$  button: Press to advance the time.

$\ominus$  button: Press to reverse the time.

About 5 seconds later, the entire display will reappear.

## About the SLEEP Timer

To prevent excessive cooling during sleep, the SLEEP timer function automatically modifies the thermostat setting in accordance with the set time setting. When the set time has elapsed, the air conditioner completely stops.

### During Cooling/Dry operation:

When the SLEEP timer is set, the thermostat setting is automatically raised 1 °C every 1 hour. When the thermostat setting is raised a total of 2 °C, the thermostat setting at that time is maintained until the set time elapses, at which time the air conditioner automatically turns off.

### SLEEP timer setting

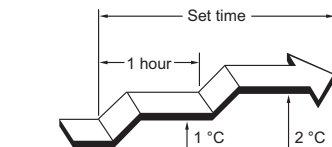

# ADJUSTING THE DIRECTION OF AIR CIRCULATION

Vertical (up-down) direction of airflow is adjusted by pressing the Remote Controller's SET button. Horizontal (right-left) airflow direction is adjusted manually, by moving the Airflow Direction Louvers.

Whenever making horizontal airflow adjustments, start air conditioner operation and be sure that the vertical air direction louvers are stopped.

## Vertical Air Direction Adjustment

Press the SET button (Fig. 5 ㉑).

Each time the button is pressed, the air direction range will change as follows:

1 ↔ 2 ↔ 3 ↔ 4 ↔ 5 ↔ 6

### Types of Airflow Direction Setting:

1, 2, 3 : During Cooling/Dry modes

1, 2, 3, 4, 5, 6 : During Fan mode

The Remote Controller's display does not change.

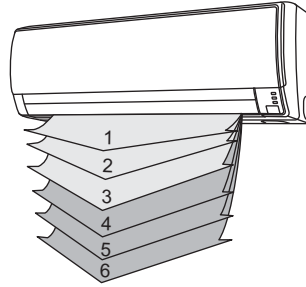

- Use the air direction adjustments within the ranges shown above.
- The vertical airflow direction is set automatically as shown, in accordance with the type of operation selected.

During Cooling/Dry mode : Horizontal flow 1

- During AUTO mode operation, for the first a few minutes after beginning operation, airflow will be horizontal 1; the air direction cannot be adjusted during this period.

## Right-Left Adjustment

Adjust the Right-Left louvers.

Move the Right-Left louvers to adjust airflow in the direction you prefer.

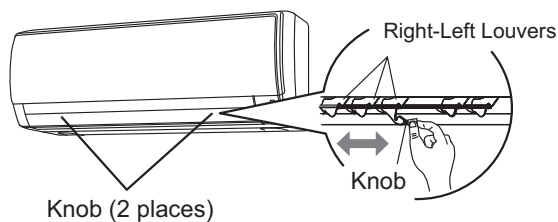

## ⚠ DANGER

Never place fingers or foreign objects inside the outlet ports, since the internal fan operates at high speed, and personal injury could be caused.

- Always use the Remote Controller's SET button to adjust the vertical airflow louvers. Attempting to move them manually could result in improper operation; in this case, stop operation and restart. The louvers should begin to operate properly again.
- During use of the Cooling and Dry modes, do not set the Airflow Direction Louvers in range (4–6) for many hours, since water vapor may condense near the outlet louvers and drops of water may drip from the indoor unit. During the Cooling and Dry modes, if the Airflow Direction Louvers are left in range 4–6 for more than 30 minutes, they will automatically return to position 3.
- When used in a room with infants, children, elderly or sick persons, the airflow direction and room temperature should be considered carefully when making settings.

## ⚠ CAUTION

When adjusting the Right-Left Louvers, it is necessary to stop the Vertical (up-down) louvers first and make sure that it stops completely before adjusting the direction.

# SWING OPERATION

Begin air conditioner operation before performing this procedure.

## To select SWING Operation

**Press the SWING button (Fig. 5 ㉓).**

The SWING Display (Fig. 6 ㉔) will light.

In this mode, the Airflow Direction Louvers will swing automatically to direct the airflow both up and down.

## To stop SWING Operation

**Press the SWING button (Fig. 5 ㉓) once again.**

The SWING Display (Fig. 6 ㉔) will go out.

Airflow direction will return to the setting before swing was begun.

## About Swing Operation

During cooling/Dry mode : Swings between 1 and 4.

The SWING operation may stop temporarily when the air conditioner's fan is not operating, or when operating at very low speeds.

# ECONOMY OPERATION

Begin Air Conditioner operation before performing this procedure.

## To Use the ECONOMY Operation

**Press the ECONOMY button (Fig.5 ㉖).**

The ECONOMY indicator Lamp (green) will light.

ECONOMY operation begins.

## To Stop the ECONOMY Operation

**Press the ECONOMY button (Fig.5 ㉖) again.**

The ECONOMY Indicator Lamp (green) (Fig. 3 ㉗) will go out.

Normal operation begins.

● Indicator Lamp

OPERATION

TIMER

ECONOMY

: Lighting     : OFF

## About ECONOMY Operation

At the maximum output, ECONOMY Operation is approximately 70% of normal air conditioner operation for cooling.

- If the room is not cooled well during ECONOMY operation, select normal operation.
- During the monitor period in the AUTO mode, the air conditioner operation will not change to ECONOMY operation even if ECONOMY operation is selected by pressing the ECONOMY operation button.
- When ECONOMY operation mode is operated, the room temperature will be little higher than the set-temp under cooling mode. Therefore, the ECONOMY mode is able to save more energy than other normal mode.

# MANUAL AUTO OPERATION

Use the MANUAL AUTO operation in the event the Remote Controller is lost or otherwise unavailable.

## How To Use the Main Unit Controls

**Press the MANUAL AUTO button (Fig. 2 ②) more than 3 seconds and less than 10 seconds on the main unit control panel.**

To stop operation, press the MANUAL AUTO button (Fig. 2 ②) for 3 seconds.

- When the air conditioner is operated by the controls on the MANUAL AUTO button, it will operate under the same mode as the AUTO mode selected on the Remote Controller (see page 8).
- The fan speed selected will be "AUTO" and the thermostat setting will be standard (24 °C).

## OPERATING TIPS

### AUTO Restart

#### In Event of Power Interruption

- The power supply to the air conditioner is stopped by a power interruption. The air conditioner will then restart automatically in its previous mode when the power is restored.
- If a power interruption occurs during TIMER operation, the timer will be reset and the indoor unit will begin (or stop) operation at the new time setting. In the event that this kind of timer fault occurs, the TIMER Indicator Lamp will flash (See page 4.)
- Use of other electrical appliances (electric shaver, etc.) or nearby use of a wireless radio transmitter may cause the air conditioner to malfunction. In this event, temporarily turn off the circuit breaker, turn it on and then use the Remote Controller to resume operation.

### Temperature and Humidity Range

Permissible ranges of temperature and humidity are as follows:

Cooling/Dry Operation	Outdoor temperature	About 18 °C to 46 °C
	Indoor temperature	About 18 °C to 32 °C
	Indoor humidity	Below approximately 80%. If the air conditioner is used continuously for many hours, water may condense on the surface and drip.

If the unit is used under higher temperature conditions than those noted here, the automatic protection circuit may operate, interrupting the operation. If the unit is used under lower temperature conditions than those noted here, the heat exchanger may freeze, causing water leakage or other malfunction.

- Do not use the air conditioner for any purpose other than cooling or drying room, or fan.

# CLEANING AND CARE



## CAUTION

- Before cleaning the indoor unit, be sure to turn it off and disconnect the Power Supply Cord.
- Be sure the Intake Grille (Fig. 1 ⑧) is installed securely.
- When removing or replacing the air filters, be sure not to touch the heat exchanger, as personal injury may result.

### Cleaning the Intake Grille

#### 1. Remove the Intake Grille.

- (1) Place your fingers at both lower ends of the grille panel, and lift forward; if the grille seems to catch partway through its movement, continue lifting upward to remove.
- (2) Pull past the intermediate catch and open the Intake Grille wide so that it become horizontal.

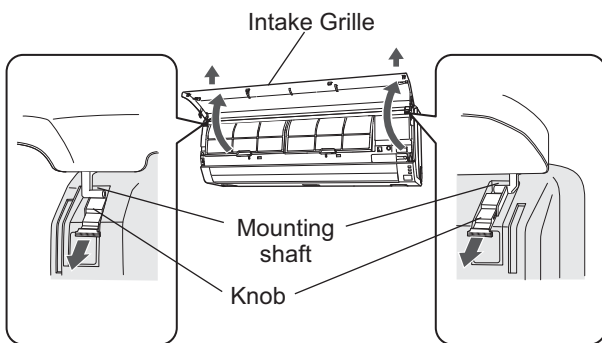

#### 2. Clean with water.

Remove dust with a vacuum cleaner; wipe the indoor unit with warm water, then dry with a clean, soft cloth.

#### 3. Replace the Intake Grille.

- (1) Pull the knobs all the way.
- (2) Hold the grille horizontal and set the left and right mounting shafts into the bearings at the top of the panel.
- (3) Press the place where the arrow on the diagram indicates and close the Intake Grille.

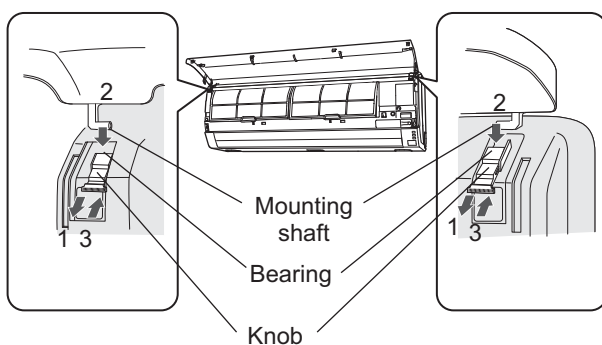

### Cleaning the Air Filter

#### 1. Open the Intake Grille, and remove the air filter.

Lift up the air filter's handle, disconnect the 2 lower tabs, and pull out.

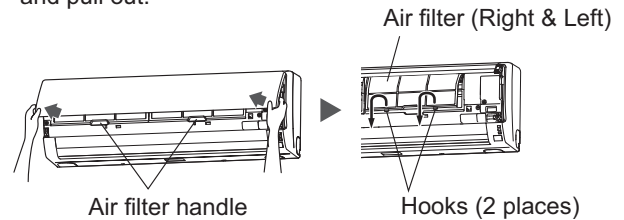

#### 2. Remove dust with a vacuum cleaner or by washing.

After washing, allow to dry thoroughly in a shaded place.

#### 3. Replace the Air Filter and close the Intake Grille.

- (1) Align the sides of the air filter with the panel, and push in fully, making sure the 2 lower tabs are returned properly to their holes in the panel.

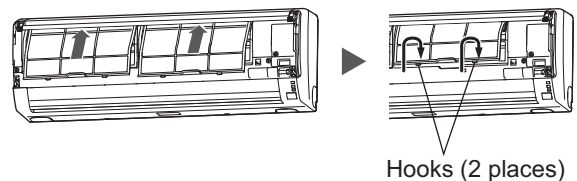

- (2) Close the Intake Grille.

(For purposes of example, the illustration shows the indoor unit without Intake Grille installed.)

- Dust can be cleaned from the air filter either with a vacuum cleaner, or by washing the filter in a solution of neutral detergent and warm water. If you wash the filter, be sure to allow it to dry thoroughly in a shady place before reinstalling.
- If dust is allowed to accumulate on the air filter, airflow will be reduced, lowering operating efficiency and increasing noise.
- During periods of normal use, the Air Filters should be cleaned every 2 weeks.
- Don't operate the air conditioner with being opened the intake grille.

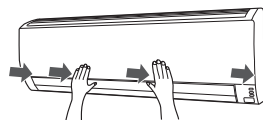

- When used for extended periods, the indoor unit may accumulate dust inside, reducing its performance. We recommend that the indoor unit be inspected regularly, in addition to your own cleaning and care. For more information, consult authorized service personnel.
- When cleaning the indoor unit's body, do not use water hotter than 40 °C, harsh abrasive cleansers, or volatile agents like benzene or thinner.
- Do not expose the indoor unit's body to liquid insecticides or hairsprays.
- When shutting down the indoor unit for 1 month or more, first allow the fan mode to operate continuously for half a day to allow internal parts to dry thoroughly.

# CLEANING AND CARE

## Air Cleaning Filter Installation

1. Open the Intake Grille and remove the Air filters.
2. Attach the air cleaning filter to the frame of the front panel.

Attach the filter on the inside of the tabs (6 places) so as not to stick out.

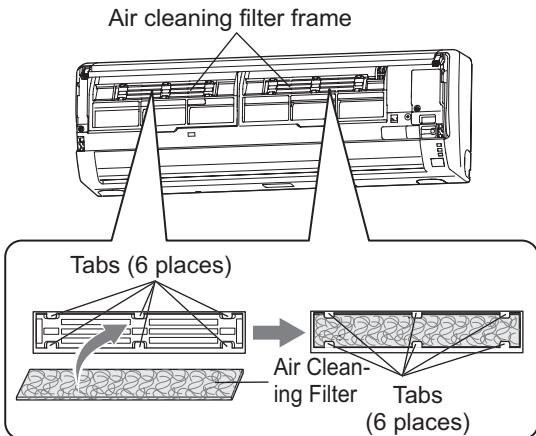

(In the above figure, the intake grille is omitted for the explanation)

3. Install the 2 Air filters and close the Intake Grille.

Do not operate the air conditioner with being opened the intake grille.

When air cleaning filters are used, the effect will increased by setting the fan speed to "High".

## Replacing dirty Air cleaning filters

Replace filters with the following components (purchased separately).

- POLYPHENOL CATECHIN AIR CLEANING FILTER : UTR-FA16
- Negative air ions deodorizing filter: UTR-FA16-2

1. Open the Intake Grille and remove the Air filters.
2. Remove the air cleaning filters attached to the frames of the front panel.

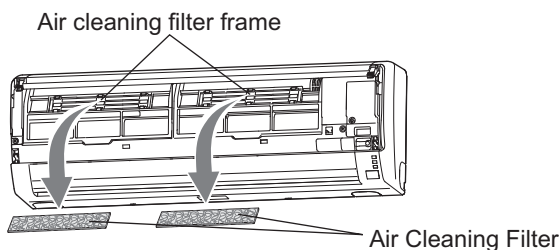

3. Replace them by 2 new Air cleaning filters.

- (1) Remove the old air cleaning filters in reverse order of their installation.

- (2) Install in the same way as for installation of the air cleaning filter set.

4. Install the 2 Air filters and close the Intake Grille.

Do not operate the air conditioner with being opened the intake grille.

## About the Air Cleaning Filters

### POLYPHENOL CATECHIN AIR CLEANING FILTER (1 sheet)

- The Air Cleaning Filters are disposable filters. (They can not be washed and reused.)
- For storage of the Air Cleaning Filters, use the filters as soon as possible after opening the package. (The air cleaning effect decreases when the filters are left in the opened package)
- Generally, the filters should be exchanged about every 3 months.

Please purchase delicated air cleaning filters (UTR-FA16: sold separately) to exchange the used dirty air cleaning filter.

### [Negative air ions deodorizing filter (1 sheet) — light blue]

- The filter should be exchanged about every 3 years so as to maintain the deodorizing effect.
- Filter frame is not a one-off product.

Please purchase delicated deodorizing filter (UTR-FA16-2: sold separately) when exchanging the filter.

## Maintenance of Deodorizing Filters

In order to maintain the deodorizing effect, please clean the filter in the follow way once 3 months.

- (1) Remove the deodorizing filter.
- (2) Clean with water and dry in the air.
  - a. Flush the filter with high-pressure hot water until the surface of the filter is covered with water. Please flush with diluent neutral detergent.
 

( Never wash by reaming or rubbing, otherwise it will damage the deodorizing effect. )
  - b. Rinse with water flow.
  - c. Dry in shade.

Reinstall the deodorizing filter.

## Filter Indicator Reset (The special setting)

Can be used if set correctly during installation.

Please consult authorized service personnel when using this function.

- It lights on when it is time to clean the air filters. Clean the filter referring to "CLEANING AND CARE". After cleaning, press the MANUAL AUTO button (Fig.2 ②) for 2 seconds or less on the indoor unit.

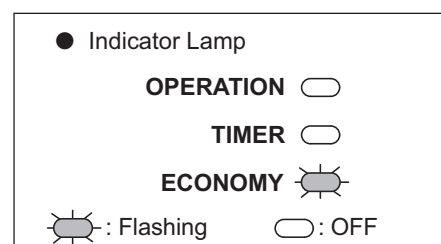

# TROUBLESHOOTING



## WARNING

In the event of a malfunction (burning smell, etc.), immediately stop operation, turn off the electrical breaker and consult authorized service personnel.

Merely turning off the unit's power switch will not completely disconnect the unit from the power source. Always be sure to turn off the electrical breaker to ensure that power is completely off.

Before requesting service, perform the following checks:

	Symptom	Problem	See page
NORMAL FUNCTION	Doesn't operate immediately:	<ul style="list-style-type: none"> <li>● If the indoor unit is stopped and then immediately started again, the compressor will not operate for about 3 minutes, in order to prevent fuse blowouts.</li> <li>● Whenever the electrical breaker is turned off then on again the protection circuit will operate for about 3 minutes, preventing unit operation during that period.</li> </ul>	—
	Noise is heard:	<ul style="list-style-type: none"> <li>● During operation or immediately after stopping the unit, the sound of water flowing in the air conditioner's piping may be heard. Also, noise may be particularly noticeable for about 2 to 3 minutes after starting operation (sound of refrigerant flowing).</li> <li>● During operation, a slight squeaking sound may be heard. This is the result of minute expansion and contraction of the front panel due to temperature changes.</li> </ul>	—
	Smells:	<ul style="list-style-type: none"> <li>● Some smell may be emitted from the indoor unit. This smell is the result of room smells (furniture, tobacco, etc.) which have been taken into the indoor unit.</li> </ul>	—
	Mist or steam is emitted:	<ul style="list-style-type: none"> <li>● During Cooling or Dry operation, a thin mist may be seen emitted from the indoor unit. This results from the sudden Cooling of room air by the cool air emitted from the indoor unit, resulting in condensation and misting.</li> </ul>	—
	Airflow is weak or stops:	<ul style="list-style-type: none"> <li>● During Dry mode, the indoor unit will operate at low speed; in order to adjust room humidity, the indoor unit's fan may stop from time to time. Also, the fan may operate at very low speed when adjusting room humidity.</li> </ul>	8
		<ul style="list-style-type: none"> <li>● During SUPER QUIET operation, the fan will operate at very low speed.</li> </ul>	7
		<ul style="list-style-type: none"> <li>● In the monitor of AUTO operation, the fan will operate at very low speed.</li> </ul>	8

	Symptom	Items to check	See page
CHECK ONCE MORE	Doesn't operate at all:	<ul style="list-style-type: none"> <li>● Has the circuit breaker been turn off?</li> <li>● Has there been a power failure?</li> <li>● Has a fuse blown out, or a circuit breaker been tripped?</li> </ul>	—
		<ul style="list-style-type: none"> <li>● Is the timer operating?</li> </ul>	9 - 10
	Poor Cooling performance:	<ul style="list-style-type: none"> <li>● Is the Air Filter dirty?</li> <li>● Are the air conditioner's intake grille or outlet port blocked?</li> <li>● Did you adjust the room temperature settings (thermostat) correctly?</li> <li>● Is there a window or door open?</li> <li>● In the case of Cooling operation, is a window allowing bright sunlight to enter? (Close the curtains.)</li> <li>● In the case of Cooling operation, are there heating apparatus and computers inside the room, or are there too many people in the room?</li> </ul>	—
<ul style="list-style-type: none"> <li>● Is the unit set for SUPER QUIET operation?</li> </ul>		7	
	The unit operates differently from the Remote Controller's setting:	<ul style="list-style-type: none"> <li>● Are the Remote Controller's batteries dead?</li> <li>● Are the Remote Controller's batteries loaded properly?</li> </ul>	6

If the problem persists after performing these checks, or if you notice burning smells, or the OPERATION Indicator Lamp (Fig. 3 ⑤) and the TIMER Indicator Lamp (Fig. 3 ⑥) flashes, and ECONOMY Indicator Lamp (Fig.3 ⑦) flashes fast. Immediately stop operation, turn off the electrical breaker and consult authorized service personnel.