

OPERATING MANUAL

AIR CONDITIONER **DUCT TYPE**

Indoor Unit
ART90EL(3)
ART90TL(3)

Outdoor Unit
AOT90EP(3)
AOT90TP(3)

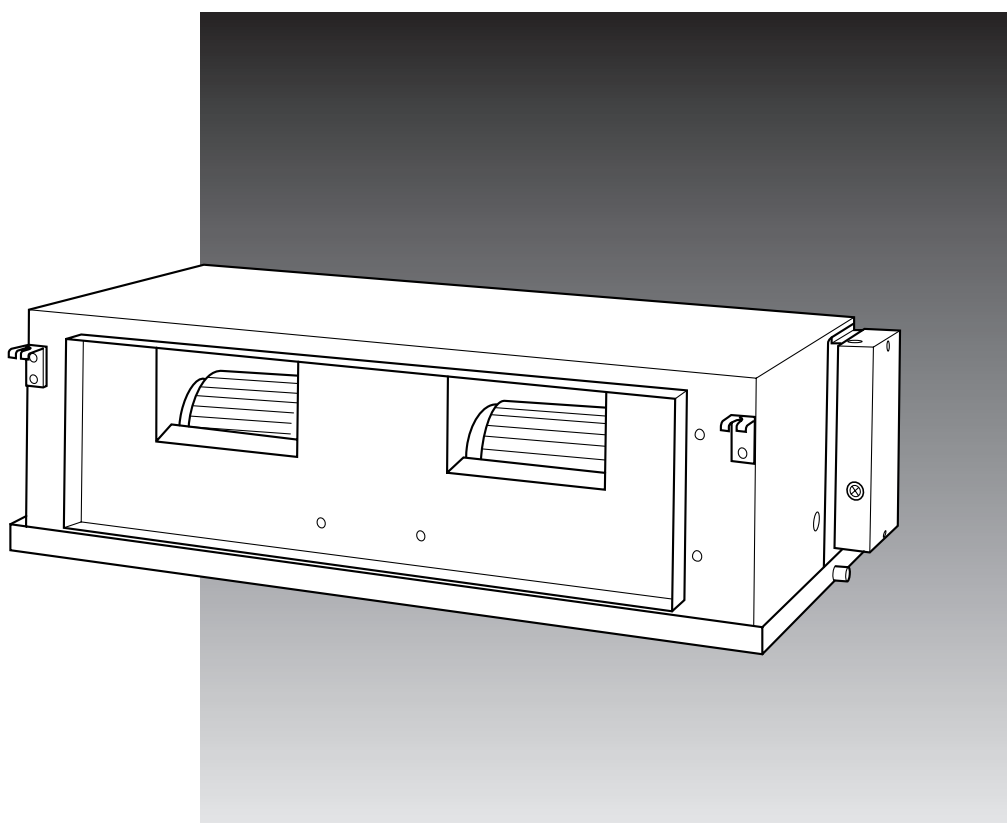



KEEP THIS OPERATION MANUAL
FOR FUTURE REFERENCE

CONTENTS

| | | | |
|--|---|---------------------------------|----|
| SAFETY PRECAUTIONS | 1 | ENERGY SAVE OPERATION | 10 |
| NAME OF PARTS | 2 | SYSTEM OPERATION | 11 |
| PREPARATION | 3 | CARE AND MAINTENANCE | 11 |
| OPERATION | 3 | OPERATION DETAILS | 12 |
| TIMER OPERATION (OFF TIMER/ON TIMER) | 4 | ERRORS AND SELF DIAGNOSIS | 13 |
| TIMER OPERATION (WEEKLY TIMER) | 5 | TROUBLESHOOTING | 13 |

SAFETY PRECAUTIONS

- Before using the appliance, read these "PRECAUTIONS" thoroughly and operate in the correct way.
- The instructions in this section all relate to safety; be sure to maintain safe operating conditions.
- "DANGER", "WARNING" and "CAUTION" have the following meanings in these instructions:

| | |
|---|--|
|  DANGER! | This mark indicates procedures which, if improperly performed, are most likely to result in the death of or serious injury to the user or service personnel. |
|  WARNING! | This mark indicates procedures which, if improperly performed, might lead to the death or serious injury of the user. |
|  CAUTION! | This mark indicates procedures which, if improperly performed, might possibly result in personal harm to the user, or damage to property. |

DANGER!

- Do not attempt to install this air conditioner by yourself.
- This unit contains no user-serviceable parts. Always consult authorized service personnel for repairs.
- When moving, consult authorized service personnel for disconnection and installation of the unit.
- Do not become over-exposed to cold air by staying in the direct path of the air flow of the air conditioner for extended periods of time.
- Do not insert fingers or objects into the outlet port or intake grilles.
- Do not start and stop air conditioner operation by turning off the electrical breaker and so on.
- In the event of a malfunction (burning smell, etc.), immediately stop operation, turn off the electrical breaker, and consult authorized service personnel.

CAUTION!

- Provide occasional ventilation during use.
- Do not direct air flow at fireplaces or heating apparatus.
- Do not climb on, or place objects on, the air conditioner.
- Do not expose the air conditioner directly to water.
- Do not operate the air conditioner with wet hands.
- Turn off power source when not using the unit for extended periods.
- Always turn off the electrical breaker whenever cleaning the air conditioner or changing the air filter.
- Connection valves become hot during Heating; handle with care.
- Check the condition of the installation stand for damage.
- Do not place animals or plants in the direct path of the air flow.
- When restarting after a long period of disuse in the winter, do:
Turn the power switch on at least 12 hours before starting the unit.
- Do not drink the water drained from the air conditioner.
- Do not use in applications involving the storage of foods, plants or animals, precision equipment, or art works.
- Do not apply any heavy pressure to radiator fins.
- Operate only with air filters installed.
- Do not block or cover the intake grille and outlet port.
- Ensure that any electronic equipment is at least one metre away from either the indoor or outdoor units.
- Avoid installing the air conditioner near a fireplace or other heating apparatus.
- When installing the indoor and outdoor unit, take precautions to prevent access to infants.
- Do not use inflammable gases near the air conditioner.

NAME OF PARTS

Instructions relating to heating (*) are applicable only to "HEAT & COOL MODEL" (Reverse Cycle).

Fig. 1

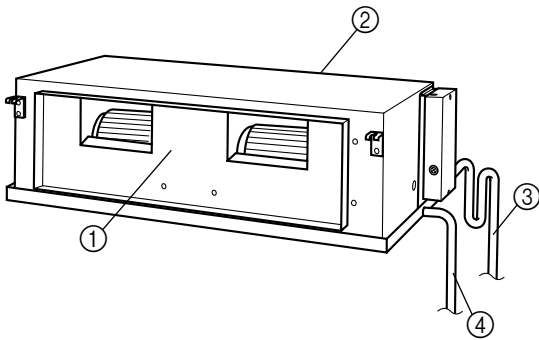
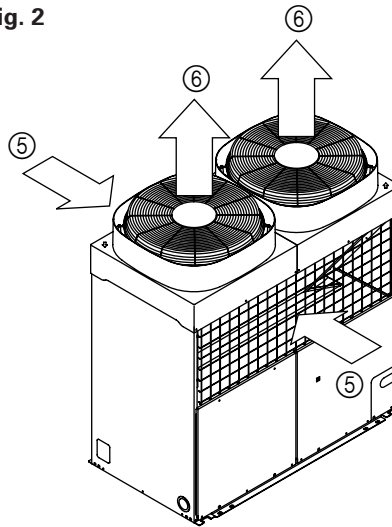

Fig. 2



Electrical Breaker

- Install this with the power supply chain during on-site installation.

Fig. 3

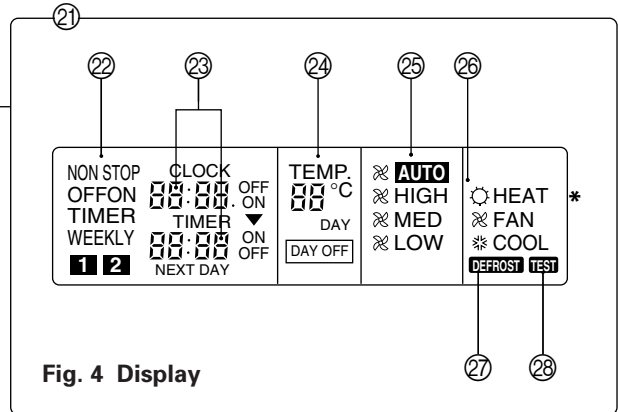
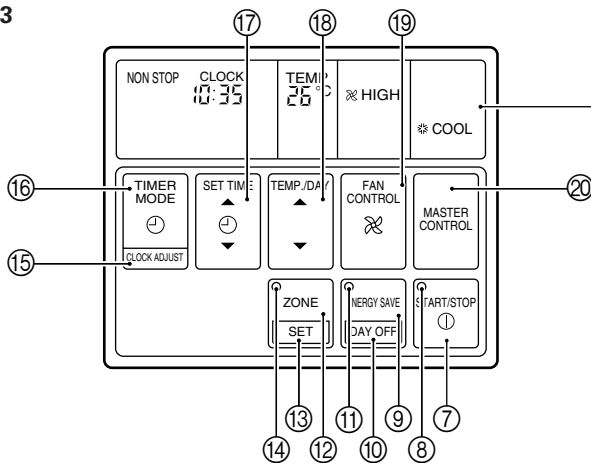

Fig. 4 Display

- For explanatory purposes, the figure showing the remote controller display shows all possible displays. The actual display shows only that area that is being adjusted or used.

Fig. 1 Indoor Unit

- ① Outlet Port
- ② Intake Port
- ③ Drain Pipe (Main)
- ④ Drain Pipe (Safety)

Fig. 2 Outdoor Unit

- ⑤ Air intake
- ⑥ Air outlet

Fig. 3 Remote Controller

- ⑦ START/STOP Button
- ⑧ Operation Lamp
- ⑨ ENERGY SAVE Button
- ⑩ DAY OFF Button
- ⑪ ENERGY SAVE Lamp
- ⑫ ZONE Control Button
- ⑬ SET Button
- ⑭ ZONE Control Lamp
- ⑮ CLOCK ADJUST Button
- ⑯ TIMER MODE Button
- ⑰ SET TIME Button
- ⑱ SET TEMP./DAY Button
- #⑲ FAN CONTROL Button
- ⑳ MASTER CONTROL Button

- ㉑ Remote Controller Display (Fig. 4)
- ㉒ Timer Mode Display
- ㉓ Clock Display (CLOCK/TIMER)
- ㉔ Set Temperature Display (TEMP.)
- #㉕ Fan Speed Display
- ㉖ Operation Mode Display
- ㉗ DEFROST Display
- ㉘ TEST Display

#NOTE:

This model does not have a fan speed function. (⑲, ㉕)

PREPARATION

Set the Current Time and Day

1 Press the CLOCK ADJUST button for more than three seconds.

2 Press the SET TEMP./DAY button and set the day.

▲: Use to advance the day forward.

▼: Use to turn the day back.

The day is indicated by a code number from 1 to 7, as shown in the table below. Set to the number that corresponds to the current day.

| | | | | | | | |
|-----------------|-----|-----|-----|-----|-----|-----|-----|
| DAY CODE | 1 | 2 | 3 | 4 | 5 | 6 | 7 |
| DAY OF THE WEEK | MON | TUE | WED | THU | FRI | SAT | SUN |

3 Press the SET TIME button and set the time.

▲: Use to advance the time forward.

▼: Use to turn the time back.

(Press once to move the time 1 minute; hold down and the time will move 10 minutes at a time.)

4 Press the CLOCK ADJUST button again.

This registers the new day and time values. The day display goes off, and the time display stops flashing.

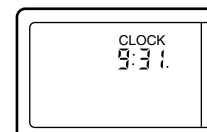
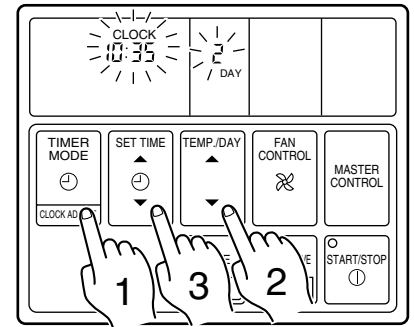

Example: Set the time to 9:31.

OPERATION

Instructions relating to heating (*) are applicable only to "HEAT & COOL MODEL" (Reverse Cycle).

To Select Mode Operation

1 Press the START/STOP button.

The unit will start and the remote controller's operation lamp (green) will light up.

2 Press the MASTER CONTROL button to select the desired mode.

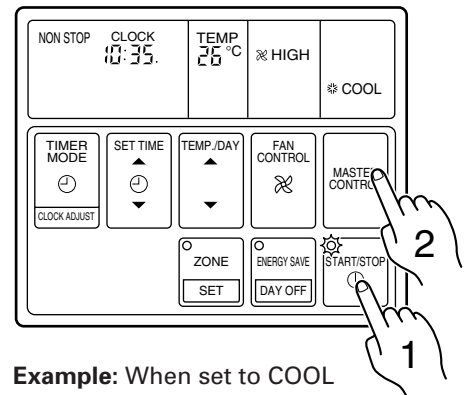
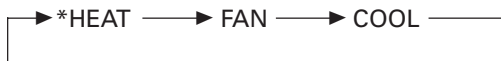

Example: When set to COOL

To Set the Thermostat

Press the SET TEMP./DAY button to the desired temperature.

▲ : Press to raise the thermostat setting.

▼ : Press to lower the thermostat setting.

●Thermostat setting range:

* Heating 16 °C to 30 °C

Cooling 18 °C to 30 °C

The thermostat cannot be used to set room temperature during the FAN mode (the temperature will not appear on the remote controller's display).

The thermostat setting should be considered a standard value, and may differ somewhat from the actual room temperature.

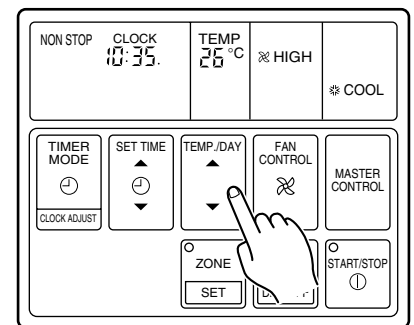

Example: When set to 26 °C

To Stop Operation

Press the START/STOP button.

The remote controller's operation lamp (green) will go out.

The display contents disappear and only the current time is displayed.

TIMER OPERATION (OFF TIMER/ON TIMER)

Before using the timer function, be sure that the remote controller is set to the correct current time and Day. Press the START/STOP button; after the unit starts operation perform the following procedure:

OFF Timer / ON Timer

1 Press the TIMER MODE button and display either OFF Timer or ON Timer.

The timer will start operating. (If you set the ON timer, the air conditioner will stop operating.)

Each time the button is pressed the timer function changes in the following order:

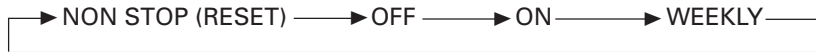

2 Press the SET TIME button and set the timer time.

▲ : Use to advance the time forward.

▼ : Use to turn the time back.

(Press once to move the time 1 minute; hold down and the time will move 10 minutes at a time.)

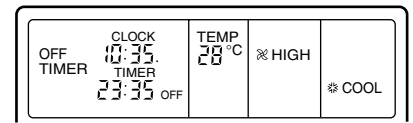
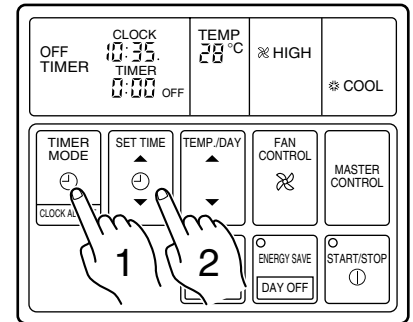

Example: Setting the OFF TIMER to 23:35

To confirm or Change Settings Before Starting Operation

- **To confirm settings**
Press the TIMER MODE button once. (The timer setting information will be displayed for 15 seconds after the TIMER MODE button is pressed.)
- **To change settings**
Confirm the settings as noted above, then press the SET TIME button and TIMER MODE button as necessary to change the desired timer setting. (The timer settings will be displayed for 15 seconds after the button is pressed.)
- After confirming or changing the settings, press the START/STOP button to start operation.

To Change the Timer Setting During Operation

Operate as noted in step 2.

To Change the Timer Mode During Operation

Press the TIMER MODE button and set the unit to the desired mode.

To Cancel the Timer Mode During Timer Operation

Press the TIMER MODE button and set the display to "NON STOP" (the unit will switch to non-stop operation).

To Stop Operation During Use of Timer Mode

Press the START/STOP button.

TIMER OPERATION (WEEKLY TIMER)

Use the weekly timer to set operating times for each day of the week.

Weekly Timer Features

- Set different operating times for each day of the week.
- Set one or two operating spans (one or two ON times and one or two OFF times) per day.
- Set time to a resolution of 5 minutes.
- OFF time can be carried over to the subsequent day.
- Use the "DAY OFF" setting to cancel operation for any day of the coming week (one-time cancellation).

Setting Up the Weekly Timer Operation

Press the START/STOP button to stop the air conditioner, and then proceed as follows.

1 Press the TIMER MODE button so that "WEEKLY" appears on the display.

The display now shows the current day (by DAY CODE), the first ON and OFF times for the day (the "WEEKLY 1" times), the fan speed, and the operating mode.

The top time value gives the ON time, and the bottom value gives the OFF time.

If either time is not set, the corresponding time display is blank "--:--".

2 Press the SET TEMP./DAY button to select the day that you want to set up.

▲ : Use to advance the day forward.

▼ : Use to turn the day back.

| DAY CODE | 1 | 2 | 3 | 4 | 5 | 6 | 7 |
|-----------------|-----|-----|-----|-----|-----|-----|-----|
| DAY OF THE WEEK | MON | TUE | WED | THU | FRI | SAT | SUN |

3 Hold the SET button down for 3 seconds.

The "WEEKLY 1" ON time starts flashing, and the fan speed and operating mode displays go off.

4 Press the SET TIME button to set the day's first ON time.

▲ : Use to advance the time forward.

▼ : Use to turn the time back.

(Press once to move the time 5 minute; hold down and the time will move 10 minutes at a time.)

5 Press the SET button.

This registers the first ON time setting for the selected day.

The ON time display stops flashing, and the "WEEKLY 1" OFF time starts flashing.

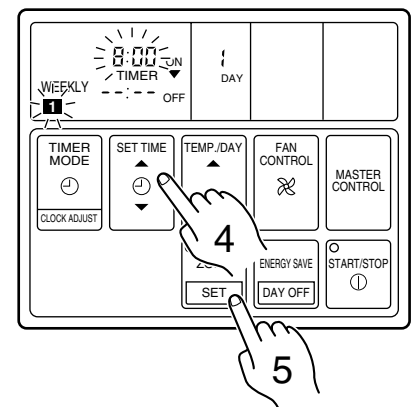
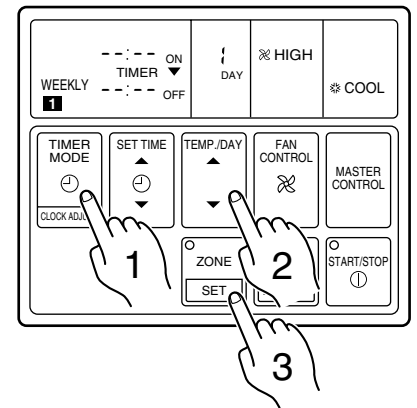

6 Press the SET TIME button to set the day's first OFF time.

The earliest OFF time you can set is 5 minutes after the ON time. The latest OFF time is 23:55 on the subsequent day.

7 Press the SET button.

This registers the first OFF time for the day, completing the "WEEKLY 1" settings for that day.

The display switches to "WEEKLY 2", and the day's second ON time begins flashing.

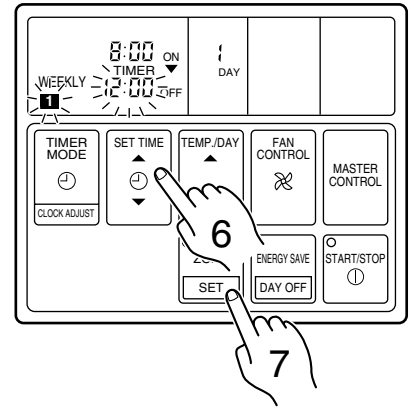

If the timer is not set, press the SET button with the time display blank "--:--", and perform next operation.

8 Repeat the operations described in Steps 4 to 7 to set the second ON and OFF times for the day (the "WEEKLY 2" times).

When you press the SET button after setting the "WEEKLY 2" OFF time, the system registers the "WEEKLY 2" settings for the day and returns you to the "WEEKLY 1" ON time setup process. (The first ON setting reappears and begins flashing.)

You can review your settings by pressing the SET button. Each press moves you to the next setting, as follows.

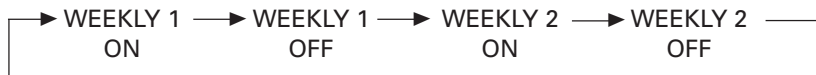

9 Press the SET TEMP./DAY button to select another day for setup. The repeat steps 4 to 8 above to set the ON and OFF times for that day.

10 When you have finished setting all of the times, hold down the SET button for 3 seconds.

The WEEKLY display flashes for 3 seconds while the new WEEKLY TIMER settings are registered, and then the clock display reappears.

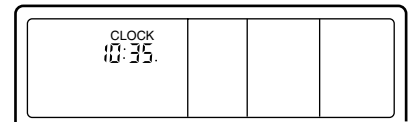

NOTES:

- (1) If no time values are flashing, the clock display will automatically reappear after 15 seconds if no buttons are pressed.
- (2) A flashing time value indicates that the system is in time-setting mode. To return to the clock display you must hold down the SET button for 3 seconds.
- (3) You do not need to set values for both WEEKLY 1 and WEEKLY 2. If you wish, you can set values only for WEEKLY 1 or only for WEEKLY 2.
- (4) The allowable range for the day's time settings is shown below.



- (5) If you set the OFF time to occur on the day following the ON time, the NEXT DAY caption appears on the display.

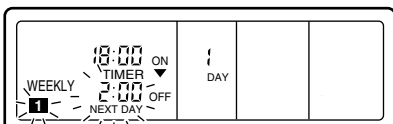

TIMER OPERATION (WEEKLY TIMER)

Starting Weekly Timer Operation

1 Press the **TIMER MODE** button so that “WEEKLY” appears on the display.

2 Press the **START/STOP** button to start operation.
(This step is not necessary if the air conditioner is already running.)

Weekly timer operation starts, and the operation lamp comes on.
(If the current time is between the first or second ON and OFF time settings for the current day, the air conditioner will start. Otherwise the air conditioner will remain off.)

The day display is replaced by the temperature display.
The upper time display now shows the current time, and the lower time display shows the next scheduled ON or OFF time.

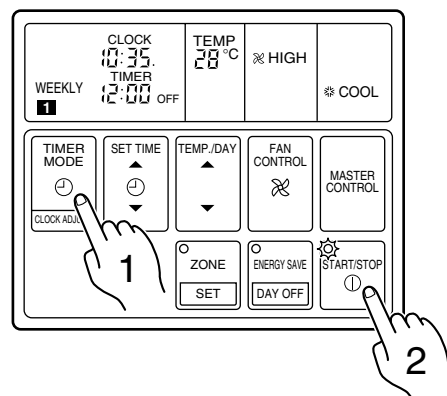

To Stop Weekly Timer Operation

- To stop weekly timer while leaving the air conditioner running:
Press the **TIMER MODE** button to select **NONSTOP**, **OFF TIMER**, or **ON TIMER**.
- To stop weekly timer operation and the air conditioner also:
Press the **START/STOP** button.

Reviewing the Time Settings

Press the **START/STOP** button to stop the air conditioner, and then proceed as follows.

- Press the **TIMER MODE** button so that “WEEKLY” appears on the display.
- Press the **SET TEMP./DAY** button to select the day that you want check.
- Press the **SET TIME** button (▲ or ▼) to switch between the “WEEKLY 1” or “WEEKLY 2” time displays.

Cancelling Selected Time Settings

Press the **START/STOP** button to stop the air conditioner, and then proceed as follows.

1 Carry out steps 1 to 3 of the “Setting Up the Weekly Timer Operation” procedure to select the day you want to edit.

2 Press the **SET** button to select the ON time that you want to cancel.

Be sure to select an ON time (the upper time display).

3 Hold down the ▼ side of the **SET TIME** button until the time display becomes blank “-:-:-”.

4 Press the **SET** button.
The first OFF time setting (“WEEKLY 1” OFF time) is deleted and replaced by a flashing blank pattern “-:-:-”.

5 Press the **SET** button again.
This completes deletion of the “WEEKLY 1” ON/OFF settings.
The second ON time setting (“WEEKLY 2” ON time) appears and flashes.
If you wish to delete other time settings, repeat steps 2 through 5.

6 Once the setting has been canceled, hold down the **SET** button for 3 seconds.
The WEEKLY display flashes briefly, and then the clock display appears.

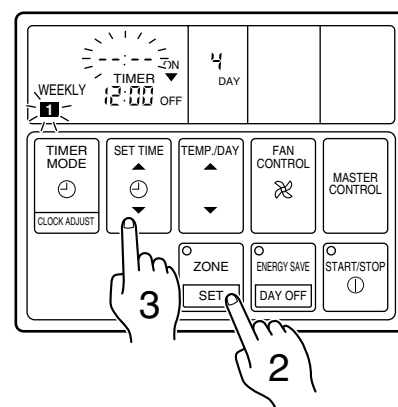

Example: Clearing the “WEEKLY 1” ON/OFF times for day 4 (Thursday)

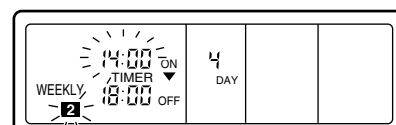
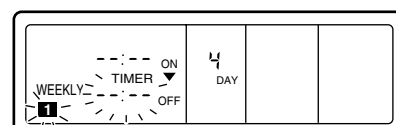

To Change Selected Time Settings

Press the START/STOP button to stop the air conditioner, and then proceed as follows.

1 Carry out steps 1 to 3 of the “Setting Up the Weekly Timer Operation” procedure to select the day you want to edit.

2 Press the SET button to select the time that you want to change.

The selected setting flashes on the display. Each press moves you to the next setting for the selected day, as follows.

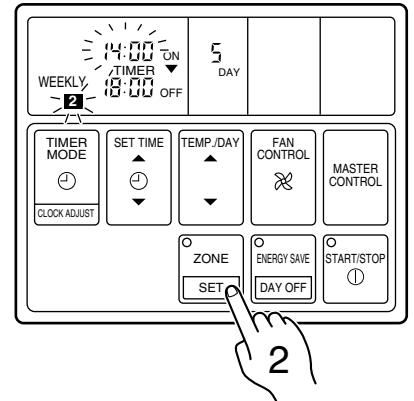
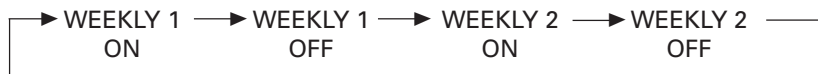

Example: Changing the “WEEKLY 2” ON setting for day 5 (Friday) from 14:00 to 15:30

3 Press the SET TIME button to change the time setting.

4 Press the SET button.

The new setting overwrites the previous setting.

5 Once the setting has been canceled, hold down the SET button for 3 seconds.

The WEEKLY display flashes briefly, and then the clock display appears.

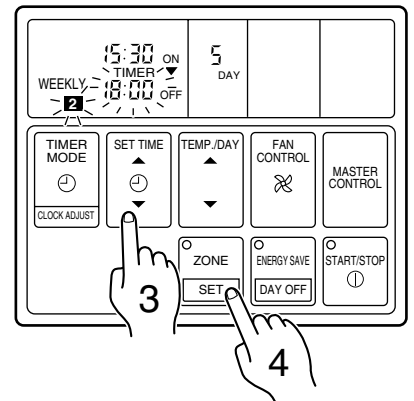

NOTES:

In the following cases, cancel the set time prior to making the required amendments.

(1) If you want to change the ON time to a time that is later than the currently set OFF time.

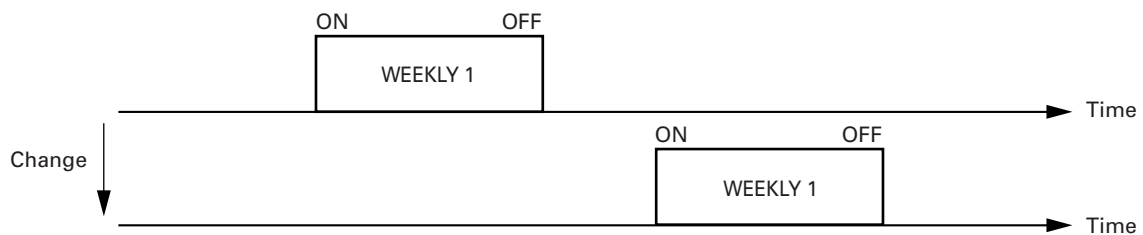

(2) If the change would cause a temporary overlap between the first and second ON/OFF time spans.

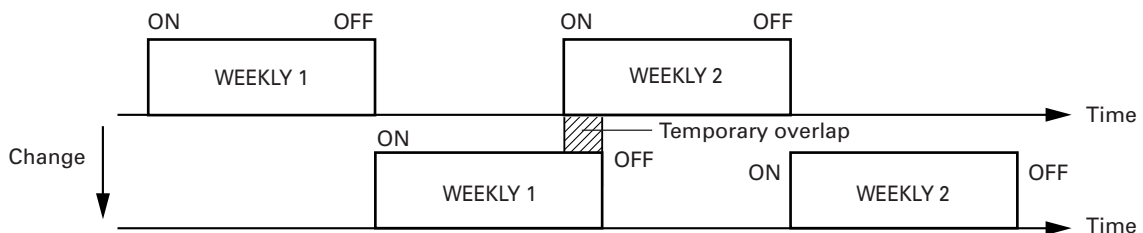

TIMER OPERATION (WEEKLY TIMER)

About the DAY OFF

- Use the DAY OFF setting to switch off timed operation for a selected day in the coming week.
- This is a temporary, one-time setting. The DAY OFF setting is automatically cleared as soon as the specified day passes.

Using the DAY OFF Setting

Press the START/STOP button to stop the air conditioner, and then proceed as follows.

1 Carry out steps 1 to 2 of the “Setting Up the Weekly Timer Operation” procedure to select the day that you want to set as the DAY OFF.

2 Press the DAY OFF button.

The DAY OFF setting is registered, and the DAY OFF caption appears on the display.

- To cancel the DAY OFF setting:
You can cancel the setting by pressing the DAY OFF button again.

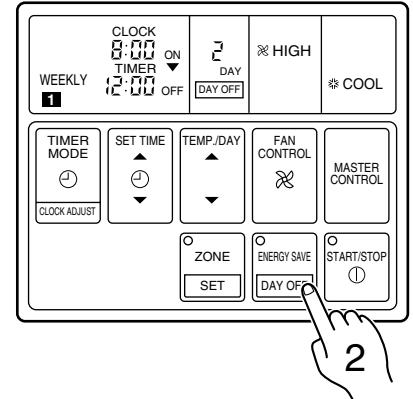

Example: To switch off timed operation for day 2 (Tuesday)

NOTES:

- (1) The DAY OFF setting is only available for days for which weekly time settings already exist.
- (2) You can make this setting for any of the next seven days (counting from the current day).
- (3) The DAY OFF setting is effective over the range illustrated below. The Weekly setting for which an ON time has been set is eligible for the day in which the DAY OFF has been set.

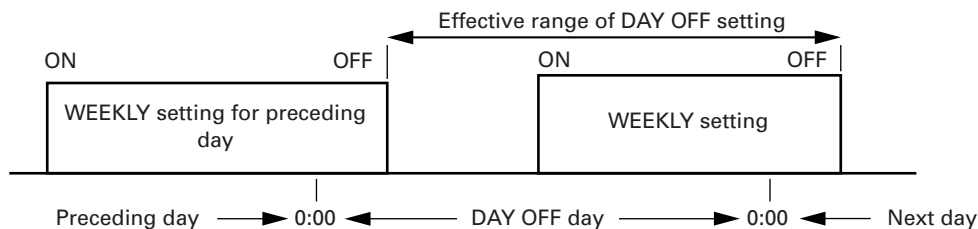

- (4) The display on the clock's lower line will usually be "--:--" for the DAY OFF set day during Weekly operations.

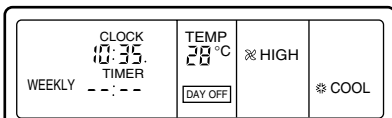

Precautions during setup

Setup is not possible in the following cases, so amend the time.

- If you set an ON time while leaving the OFF time setting blank:
Nothing will happen when you press the SET button.
To proceed, press the SET TIME button and enter an appropriate setting.
- When an attempt is made to set only the OFF time.
Nothing will happen when you press the SET TIME button.
Press the SET button and amend the entry for the ON time.
- ON and OFF times cannot be set to the same value.
- The OFF time cannot be set earlier than the ON time.
- The WEEKLY 2 settings cannot be set earlier than the WEEKLY 1 settings.
- The WEEKLY 1 and WEEKLY 2 time spans cannot overlap.

ENERGY SAVE OPERATION

Instructions relating to heating (*) are applicable only to "HEAT & COOL MODEL" (Reverse Cycle).

To Use the ENERGY SAVE

Press the ENERGY SAVE button.

The unit will run in the ENERGY SAVE mode.

The ENERGY SAVE lamp (green) will light.

To Stop the ENERGY SAVE

Press the ENERGY SAVE button one more time.

The ENERGY SAVE mode will be turned off.

The ENERGY SAVE lamp goes off, and the unit will return to the former operating conditions.

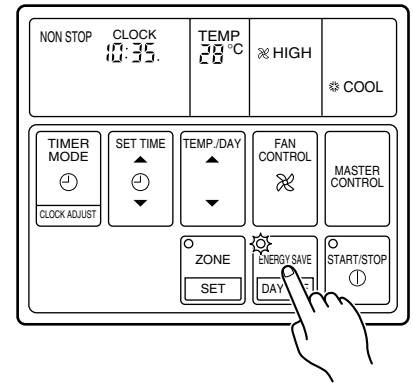

About the ENERGY SAVE

- The energy conservation mode (ENERGY SAVE) raises the set temperature slightly in the cooling mode and lowers the set temperature in the heating mode, using a computer program to economically control the operation of the unit.
- If you press the ENERGY SAVE button while the air conditioner is on, it will change to the conservation mode. If you press the ENERGY SAVE button while the unit is in the timer mode (ON timer, WEEKLY timer), the unit will go into the conservation mode when the unit starts with the timer.
- If you turn off the air conditioner while in the conservation mode, the mode will be shut off.
- The temperature set on the remote controller will not change if the energy save mode is used.

■ * When Heating

After the ENERGY SAVE button is pressed, the set temperature will be lowered about 1 °C every 30 minutes. When it has lowered a total of 2 °C, then it will hold that temperature.

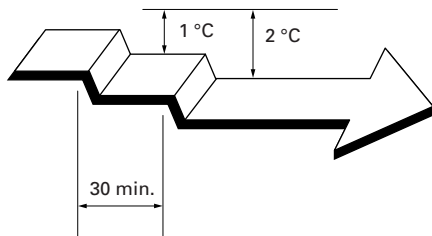

▲ Set to the ENERGY SAVE mode.

■ When Cooling

After the ENERGY SAVE button is pressed, the set temperature will be raised about 0.5 °C every 30 minutes. When it has gone up a total of 1 °C, then it will hold that temperature.

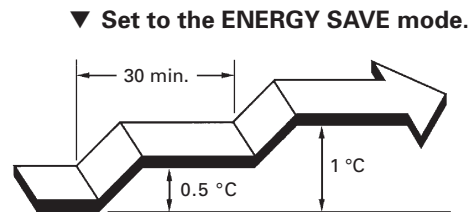

▼ Set to the ENERGY SAVE mode.

SYSTEM OPERATION

<Control Several Units with just one Remote Controller>

One remote controller can control up to 16 air conditioners. All the air conditioners can be operated with the same setting.

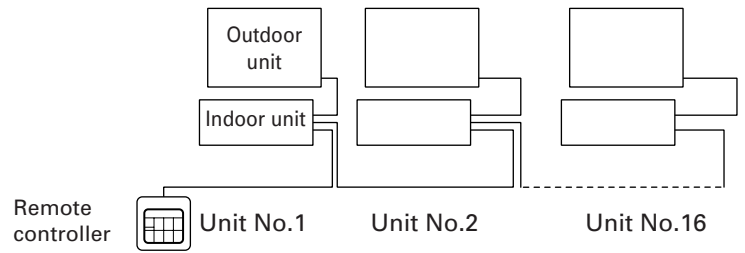

To Use the ZONE CONTROL

When the ZONE control button is pressed while multiple air conditioners are being centralized controlled, only the preset air conditioners stop.

Press the ZONE control button.

Preset units will stop.

The ZONE lamp (green) will light.

To Stop the ZONE CONTROL

Press the ZONE control button one more time.

Those units that were stopped will start again.

The ZONE lamp will go out.

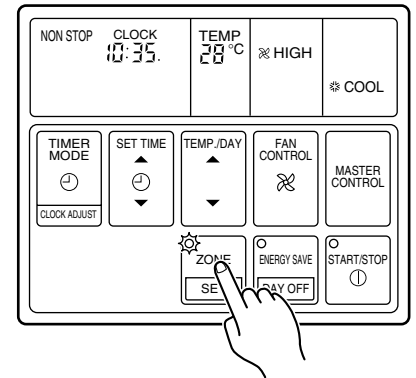

CARE AND MAINTENANCE

CAUTION!

- Before cleaning the unit, be sure to stop the unit and disconnect the power supply.
- Turn off the electrical breaker.
- A fan operates at high speed inside the unit, and personal injury could result.

Installing the Air Filter

Be sure the filter is always installed in the inlet air grille of the indoor unit.

Filters can be purchased through your local dealer.

Cleaning the Air Filter

If dirt is allowed to collect in the air filter, the airflow will be reduced, leading to reduced performance, and increased operation noise. Be sure to clean the filters regularly.

How to Cleaning

Use a vacuum cleaner to remove dust and dirt from the air filter, or wash in a synthetic detergent. After washing, dry in a shaded place, then reinstall.

- When used for extended periods, the unit may accumulate dirt inside, reducing its performance. We recommend that the unit be inspected regularly, in addition to your own cleaning and care. For more information, consult authorized service personnel.
- When cleaning the unit's body, do not use water hotter than 40 °C, harsh abrasive cleansers, or volatile agents like benzene or thinner.
- Do not expose the unit body to liquid insecticides or hairsprays.
- If the unit will not be operated for a period of one month or more, be sure to allow the inner parts of the unit to dry thoroughly, in advance, by operating the unit in fan mode for half a day.

OPERATION DETAILS

Instructions relating to heating (*) are applicable only to "HEAT & COOL MODEL" (Reverse Cycle).

Please read and understand the following details regarding this air conditioner.

Operation and Performance

* Heating Performance

- This air conditioner uses a heat pump which absorbs heat from outside air and brings it indoors. As a result, its heating performance is reduced as the temperature of outside air drops. If you find that insufficient room heat is produced, we recommend that you use the air conditioner together with other heating appliances.
- Heat-pump type air conditioners use warm-air recirculation to warm your entire room. As a result, some time will be required after starting operation until your entire room becomes warm.

* When Indoor and Outdoor Temperatures are High

When both indoor and outdoor temperatures are high during use of the heating mode, the outdoor unit's fan may stop at times.

* Microcomputer-controlled Automatic Defrosting

When the outside temperature is low and the humidity high, frost will collect on the outside unit, reducing heater efficiency. When this happens, the computer will automatically start the defrost cycle. During the defrost cycle, the indoor fan will shutdown and **DEFROST** will be displayed on the remote controller. It will take anywhere from 4 to 15 minutes before the air conditioner starts up again.

Low Ambient Cooling

When the outdoor temperature drops, the outdoor unit's fans may switch to Low Speed, or one of the fans may stop intermittently.

AUTO Restart

In Event of Power Interruption

- Should the power supply to the air conditioner be interrupted by a power failure, the air conditioner will restart automatically in the previously selected mode once the power is restored.
- Use of other electrical appliances (electric shaver, etc.) or nearby use of a wireless radio transmitter may cause the air conditioner to malfunction. In this event, temporarily turn off the circuit breaker turn it on again and then use the remote controller to resume operation.

Temperature and Humidity Range

Permissible range of temperature and humidity are as follows:

| | | Cooling Mode | *Heating Mode |
|---------------------|-----------------------------------|--|--------------------|
| Outdoor temperature | COOLING MODEL | About 0 to 46 °C | — |
| | HEAT & COOL MODEL (Reverse Cycle) | About 0 to 46 °C | About -10 to 21 °C |
| Indoor temperature | | About 18 °C to 30 °C | About below 30 °C |
| Indoor humidity | | About 80 % or less If the unit is used for long periods under high-humidity conditions, condensation may form on the surface of the indoor unit, and drip onto the floor or other objects underneath. | — |

- If the air conditioner is operated under higher temperature conditions than those listed, the built-in protection circuit may operate to prevent internal circuit damage. Also, during Cooling mode, if the unit is used under conditions of lower temperatures than those listed above, the heat-exchanger may freeze, leading to water leakage and other damage.
- Do not use this unit for any purposes other than the Cooling, (*)Heating, Dehumidifying, and air-circulation of rooms in ordinary dwellings.

ERRORS AND SELF DIAGNOSIS

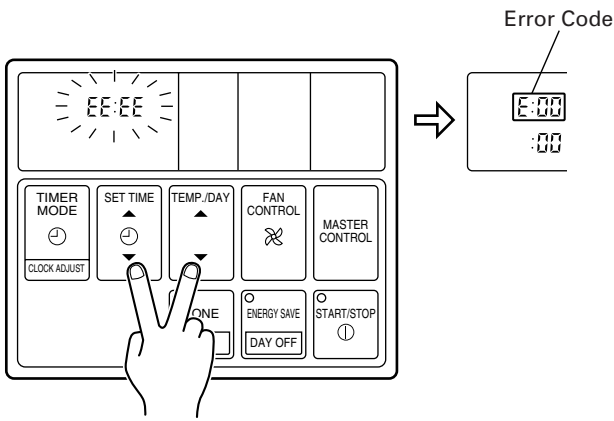

If there is a problem with the air conditioner, it will stop running and "EE: EE" will be displayed instead of the clock.

- (1) If the operation lamp is on then press the **START/STOP** button to turn it off.
- (2) Press the **SET TIME (▼)** and the **SET TEMP./DAY (▼)** buttons at the same time for more than three seconds to start the self diagnosis check.
An error code will be displayed in the clock display area.
- (3) Press the **SET TIME (▼)** and the **SET TEMP./DAY (▼)** buttons again for more than three seconds to end the self diagnosis check.

| Error Code | Error contents |
|------------|---|
| E:00 | Communication error (indoor unit ↔ remote controller) |
| E:01 | Communication error (indoor unit ↔ outdoor unit) |
| E:02 | Room temperature sensor open |

| | |
|------|--|
| E:03 | Room temperature sensor shortcircuited |
| E:04 | Indoor heat exchanger temperature sensor open |
| E:05 | Indoor heat exchanger temperature sensor shortcircuited |
| E:06 | Outdoor heat exchanger temperature sensor open |
| E:07 | Outdoor heat exchanger temperature sensor shortcircuited |
| E:08 | Power source connection error |
| E:09 | Float switch operated |
| E:0A | Outdoor temperature sensor open |
| E:0B | Outdoor temperature sensor shortcircuited |
| E:0C | Discharge pipe temperature sensor open |
| E:0D | Discharge pipe temperature sensor shortcircuited |
| E:0E | Outdoor high pressure abnormal |
| E:0F | Discharge pipe temperature abnormal |
| E:11 | Model abnormal |
| E:12 | Indoor fan abnormal |
| E:13 | Outdoor signal abnormal |
| E:14 | Outdoor EEPROM abnormal |

TROUBLESHOOTING

Instructions relating to heating (*) are applicable only to "HEAT & COOL MODEL" (Reverse Cycle).

WARNING!

In the event of a malfunction (burning smell, etc.), immediately stop operation, turn off the electrical breaker, and consult authorized service personnel.

Merely turning off the unit's power switch will not completely disconnect the unit from the power source. Always be sure to turn off the electrical breaker to ensure that power is completely off.

Before requesting service, perform the following checks:

| | Symptom | Problem | See Page |
|-----------------|------------------------------|---|----------|
| NORMAL FUNCTION | Doesn't operate immediately: | <ul style="list-style-type: none"> ● If the unit is stopped and then immediately started again, the compressor will not operate for about 3 minutes, in order to prevent fuse blowouts. ● Whenever the electrical breaker is turned off then on again, the protection circuit will operate for about 3 minutes, preventing unit operation during that period. | — |

| | Symptom | Problem | See Page |
|--------------------|--|--|----------|
| NORMAL FUNCTION | Noise is heard: | ● During operation and immediately after stopping the unit, the sound of water flowing in the air conditioner's piping may be heard. Also, noise may be particularly noticeable for about 2 to 3 minutes after starting operation (sound of coolant flowing). | — |
| | | *● During Heating operation, a sizzling sound may be heard occasional. This sound is produced by the Automatic Defrosting operation. | 12 |
| | Smells: | ● Some smell may be emitted from the indoor unit. This smell is the result of room smells (furniture, tobacco, etc.) which have been taken into the air conditioner. | — |
| | Mist or steam are emitted: | ● During Cooling, a thin mist may be seen emitted from the indoor unit. This results from the sudden Cooling of room air by the air emitted from the air conditioner, resulting in condensation and misting. | — |
| | | *● During Heating operation, the outdoor unit's fan may stop, and steam may be seen rising from the unit. This is due to Automatic Defrosting operation. | 12 |
| | Air flow is stops: | *● When Heating operation is started, fan is temporarily stop, to allow internal parts to warm up. *● During Heating operation, if the room temperature rises above the thermostat setting, the indoor and the outdoor unit will stop. If you wish to warm the room further, set the thermostat for a higher setting. | — |
| | | *● During Heating operation, the unit will temporarily stop operation (between 2 and 16 minutes) as the Automatic Defrosting mode operates. During Automatic Defrosting operation, DEFROST will be shown on the remote controller display. | 12 |
| | | ● The fan may stop when the unit is monitoring the room's temperature. | — |
| | Water is produced from the outdoor unit: | *● During Heating operation, water may be produced from the outdoor unit due to Automatic Defrosting operation. | 12 |

| | Symptom | Items to check | See Page |
|--------------------|---|--|----------|
| CHECK ONCE MORE | Doesn't operate at all: | ● Has there been a power failure? ● Has a fuse blown out, or a circuit breaker been tripped? | — |
| | | ● Is the timer operating? | 4 |
| | Poor Cooling (or *Heating) performance: | ● Is the air filter dirty? ● Are the air conditioner's intake grille or outlet port blocked? ● Did you adjust the room temperature settings (thermostat) correctly? ● Is there a window or door open? ● In the case of Cooling operation, is a window allowing bright sunlight to enter? (Close the curtains.) ● In the case of Cooling operation, are there heating apparatus and computers inside the room, or are there too many people in the room? | — |

If the problem persists after performing these checks, or if you notice burning smells, stop operation immediately, turn off the electrical breaker, and consult with authorized service personnel.