

OPERATING MANUAL

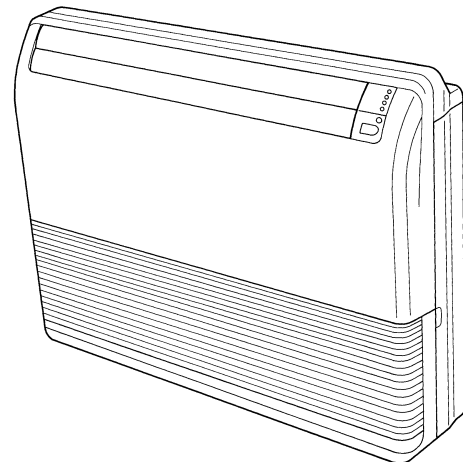

AIR CONDITIONER
**FLOOR CONSOLE/
UNDER CEILING
DUAL TYPE**

ABT Series

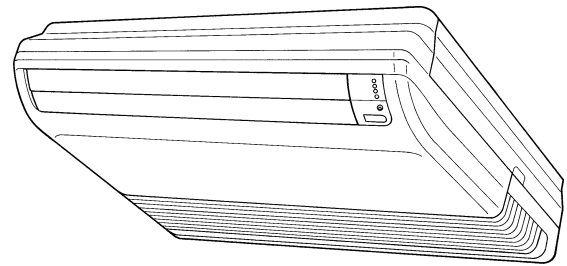

CAUTION

**R410A
REFRIGERANT**

This Air Conditioner contains and operates with refrigerant R410A and Polyol Ester oil.

THIS PRODUCT MUST ONLY BE INSTALLED OR SERVICED BY QUALIFIED PERSONNEL.

Refer to Commonwealth, State, Territory and local legislation, regulations, codes, installation & operation manuals, before the installation, maintenance and/or service of this product.

**KEEP THIS MANUAL
FOR FUTURE REFERENCE**

FUJITSU GENERAL LIMITED



P/N9374379286-02

CONTENTS

SAFETY PRECAUTIONS	1	ADJUSTING THE DIRECTION OF	
FEATURES AND FUNCTIONS	2	AIR CIRCULATION	9
NAME OF PARTS	2	SWING OPERATION	10
PREPARATION	4	ECONOMY OPERATION	10
OPERATION	5	CLEANING AND CARE	11
TIMER OPERATION	7	SELECTING THE REMOTE CONTROLLER	
SLEEP TIMER OPERATION	8	SIGNAL CODE	12
FILTER LAMP RESET	8	TROUBLESHOOTING	12
MANUAL AUTO OPERATION	8	OPERATING TIPS	14
		TEMPERATURE AND HUMIDITY RANGE	17

SAFETY PRECAUTIONS

- Before using the appliance, read these "PRECAUTIONS" thoroughly and operate in the correct way.
- The instructions in this section all relate to safety; be sure to maintain safe operating conditions.
- "DANGER", "WARNING" and "CAUTION" have the following meanings in these instructions:

 DANGER!	This mark indicates procedures which, if improperly performed, are most likely to result in the death of or serious injury to the user or service personnel.
 WARNING!	This mark indicates procedures which, if improperly performed, might lead to the death or serious injury of the user.
 CAUTION!	This mark indicates procedures which, if improperly performed, might possibly result in personal harm to the user, or damage to property.

DANGER!

- Do not attempt to install this air conditioner by yourself.
- This unit contains no user-serviceable parts. Always consult authorized service personnel for repairs.
- When moving, consult authorized service personnel for disconnection and installation of the unit.
- Do not become over-exposed to cold air by staying in the direct path of the airflow of the air conditioner for extended periods of time.
- Do not insert fingers or objects into the outlet port or intake grilles.
- Do not start and stop air conditioner operation by disconnecting the power supply cable and so on.
- Take care not to damage the power supply cable.
- In the event of a malfunction (burning smell, etc.), immediately stop operation, turn off the electrical breaker, and consult authorized service personnel.
- In the event of the refrigerant leakage, be sure to keep it away from fire or any flammables. (consult an authorized service personnel)
- If the power supply cable of this appliance is damaged, it should only be replaced by the authorized service personnel, since special purpose tools and specified cable are required.

CAUTION!

- Provide occasional ventilation during use.
- Do not direct air flow at fireplaces or heating apparatus.
- Do not climb on, or place objects on, the air conditioner.
- Do not hang objects from the indoor unit.
- Do not set flower vases or water containers on top of air conditioners.
- Do not expose the air conditioner directly to water.
- Do not operate the air conditioner with wet hands.
- Do not pull power supply cable.
- Turn off power source when not using the unit for extended periods.
- Always turn off the electrical breaker whenever cleaning the air conditioner or changing the air filter.
- Connection valves become hot during Heating; handle with care.
- When restarting after a long period of disuse in the winter, turn the power switch on at least 12 hours before starting the unit.
- Check the condition of the installation stand for damage.
- Do not place animals or plants in the direct path of the air flow.
- Do not drink the water drained from the air conditioner.
- Do not use in applications involving the storage of foods, plants or animals, precision equipment, or art works.
- Do not apply any heavy pressure to radiator fins.
- Operate only with air filters installed.
- Do not block or cover the intake grille and outlet port.
- Ensure that any electronic equipment is at least one metre away from either the indoor or outdoor units.
- Avoid installing the air conditioner near a fireplace or other heating apparatus.
- When installing the indoor and outdoor units, take precautions to prevent access by infants.
- Do not use inflammable gases near the air conditioner.
- Install the drain hose so that it drains water properly.
- This appliance is not intended for use by persons (including children) with reduced physical, sensory or mental capabilities, or lack of experience and knowledge, unless they have been given supervision or instruction concerning use of the appliance by a person responsible for their safety. Children should be supervised to ensure that they do not play with the appliance.

FEATURES AND FUNCTIONS

AUTOMATIC OPERATION

- **COOLING MODEL**
Merely press the START/STOP button, and the unit will begin automatic operation in the Cooling or Dry mode as appropriate, in accordance with the thermostat setting and the actual temperature of the room.
- **HEAT & COOL MODEL (REVERSE CYCLE)**
Merely press the START/STOP button, and the unit will begin automatic operation in either the Heating, Cooling or Monitor modes as appropriate, in accordance with the thermostat setting and the actual temperature of the room.

SLEEP TIMER

- **COOLING MODEL**
When the SLEEP timer button is pressed during Cooling or Dry mode, the thermostat setting is gradually raised during the period of operation. When the set time is reached, the unit automatically turns off.
- **HEAT & COOL MODEL (REVERSE CYCLE)**
When the SLEEP timer button is pressed during Heating mode, the air conditioner's thermostat setting is gradually lowered during the period of operation; during Cooling or Dry mode, the thermostat setting is gradually raised during the period of operation. When the set time is reached, the unit automatically turns off.

WIRELESS REMOTE CONTROLLER

The WIRELESS REMOTE CONTROLLER allows convenient control of air conditioner operation.

OMNI-DIRECTIONAL AIR FLOW (SWING OPERATION)

Three-dimensional control over air direction swing is possible through dual use of both an UP/DOWN air direction swing and RIGHT/LEFT air direction swing. Since UP/DOWN air direction flaps operate automatically according to the operating mode of the unit, it is possible to set air direction based on the operating mode.

MILDEW-RESISTANT FILTER

The AIR FILTER has been treated to resist mildew growth, thus allowing cleaner use and easier care.

NAME OF PARTS

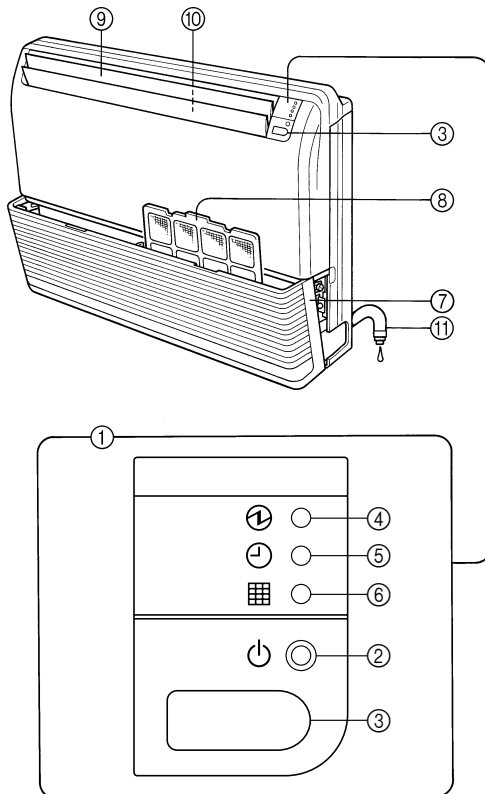

Indoor Unit

- ① **Operating Control Panel**
- ② **MANUAL AUTO button**
- ③ **Remote Controller Signal Receiver**
- ④ **OPERATION Indicator Lamp (green)**
- ⑤ **TIMER Indicator Lamp (orange)**
- ⑥ **FILTER Lamp (red)**
 - If the TIMER indicator lamp flashes when the timer is operating, it indicates that a fault has occurred with the timer setting (see page 15 AUTO Restart).
- ⑦ **Intake Grille**
- ⑧ **Air Filter**
- ⑨ **UP/DOWN Air Direction Flaps**
- ⑩ **RIGHT/LEFT Air Direction Louvers (behind UP/DOWN Air Direction Flaps)**
- ⑪ **Drain Hose**

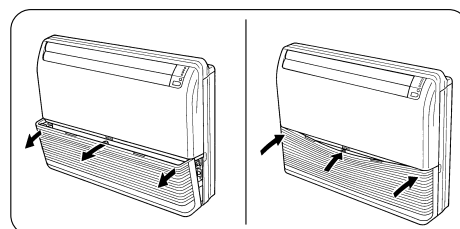

NAME OF PARTS

Remote controller

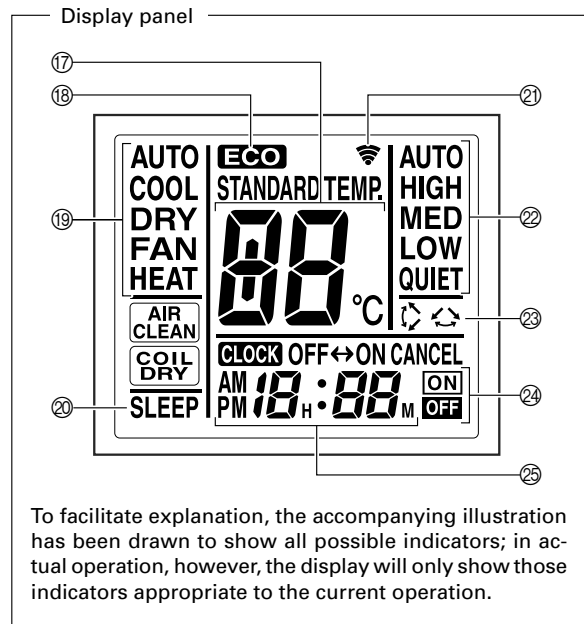
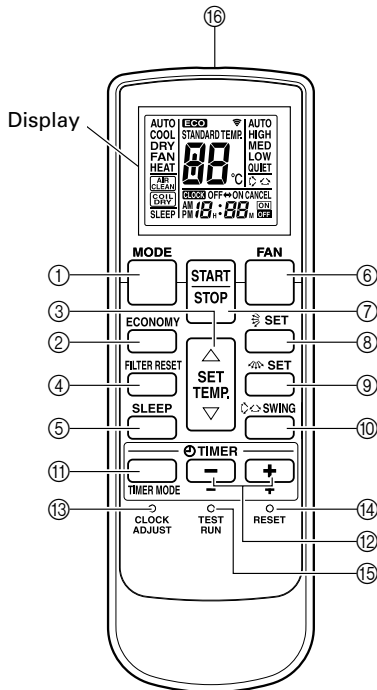

To facilitate explanation, the accompanying illustration has been drawn to show all possible indicators; in actual operation, however, the display will only show those indicators appropriate to the current operation.

- ① **MODE button**
- ② **ECONOMY button**
- ③ **SET TEMP. button (▲ / ▼)**
- ④ **FILTER RESET button**
- ⑤ **SLEEP button**
- ⑥ **FAN button**
- ⑦ **START/STOP button**
- ⑧ **SET button (Vertical)**
- ⑨ **SET button (Horizontal)**
- ⑩ **SWING button**
- ⑪ **TIMER MODE button**
- ⑫ **TIMER SET (+ / -) button**
- ⑬ **CLOCK ADJUST button**
- ⑭ **RESET button**
- ⑮ **TEST RUN button**

- ⑯ **Signal Transmitter**
- ⑰ **Temperature SET Display**
- ⑱ **ECONOMY Display**
- ⑲ **Operating Mode Display**
- ⑳ **SLEEP Display**
- ㉑ **Transmit Indicator**
- ㉒ **Fan Speed Display**
- ㉓ **SWING Display**
- ㉔ **Timer Mode Display**
- ㉕ **Clock Display**

- This button is used when installing the conditioner, and should not be used under normal conditions, as it will cause the air conditioner's thermostat function to operate incorrectly.
- If this button is pressed during normal operation, the unit will switch to test operation mode, and the Indoor Unit's OPERATION Indicator Lamp and TIMER Indicator Lamp will begin to flash simultaneously.
- To stop the test operation mode, press the START/STOP button to stop the air conditioner.

Some indoor units may not be equipped with the functions corresponding to all of the buttons on this remote controller. The indoor unit will beep and the OPERATION, TIMER and FILTER lamp flash when a remote controller button is pressed if the function is not available.

PREPARATION

Load Batteries (R03/LR03 × 2)

- 1 Press and slide the battery compartment lid on the reverse side to open it.**

Slide in the direction of the arrow while pressing the ▼ mark.

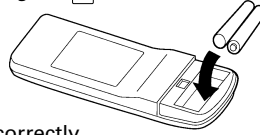

- 2 Insert batteries.**

Be sure to align the battery polarities (+/−) correctly.

- 3 Close the battery compartment lid.**

⚠ CAUTION!

- Take care to prevent infants from accidentally swallowing batteries.
- When not using the Remote Controller for an extended period, remove the batteries to avoid possible leakage and damage to the unit.
- If leaking battery fluid comes in contact with your skin, eyes, or mouth, immediately wash with copious amounts of water, and consult your physician.
- Dead batteries should be removed immediately and disposed of properly, either in a battery collection receptacle or to the appropriate authority.
- Do not attempt to recharge dry batteries.

Set the Current time

- 1 Press the CLOCK ADJUST button.**

Use the tip of a ball-point pen or other small object to press the button.

- 2 Use the TIMER SET (+ / −) buttons to adjust the clock to the current time.**

+ button: Press to advance the time.

− button: Press to reverse the time.

(Each time the buttons are pressed, the time will be advanced/reversed in one-minute increments; hold the buttons depressed to change the time quickly in ten-minute increments.)

- 3 Press the CLOCK ADJUST button again.**

This completes the time setting and starts the clock.

Never mix new and used batteries, or batteries of different types.

Batteries should last about one year under normal use. If the Remote Controller's operating range becomes appreciably reduced, replace the batteries and press the RESET button with the tip of a ballpoint pen or other small object.

To Use the Remote Controller

- The Remote Controller must be pointed at signal receiver to operate correctly.
- Operating Range: About 7 meters.
- When a signal is properly received by the air conditioner, a beeping sound will be heard.
- If no beep is heard, press the Remote Controller button again.

Remote Controller Holder

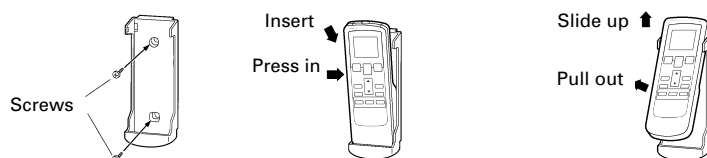

- 1 Mount the Holder.**
- 2 Set the Remote Controller.**
- 3 To remove the Remote Controller (when use at hand).**

OPERATION

To Select Mode Operation

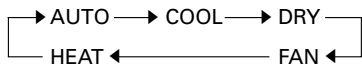
- 1 Press the START/STOP button.**
The indoor unit's OPERATION Indicator Lamp (green) will light.
The air conditioner will start operating.
- 2 Press the MODE button to select the desired mode.**
Each time the button is pressed, the mode will change in the following order.

About three seconds later, the entire display will reappear.

To Set the Room temperature

Press the SET TEMP. button.

- ▲ button:** Press to raise the thermostat setting.
- ▼ button:** Press to lower the thermostat setting.

● Thermostat setting range:

AUTO	18-30 °C
Heating	16-30 °C
Cooling/Dry	18-30 °C

The thermostat cannot be used to set room temperature during the FAN mode (the temperature will not appear on the Remote Controller's Display).

About three seconds later, the entire display will reappear.

The thermostat setting should be considered a standard value, and may differ somewhat from the actual room temperature.

To Set the Fan Speed

Press the FAN button.

Each time the button is pressed, the fan speed changes in the following order:



About three seconds later, the entire display will reappear.

When set to AUTO:

- Heating:** Fan operates so as to optimally circulate warmed air.
However, the fan will operate at very low speed when the temperature of the air issued from the indoor unit is low.
- Cooling:** As the room temperature approaches that of the thermostat setting, the fan speed becomes slower.
- Fan:** The fan runs at the low fan speed.

The fan will operate at a very low setting during Monitor operation and at the start of the Heating mode.

QUIET Operation

When set to Quiet:

QUIET operation begins. The indoor unit's airflow will be reduced for quieter operation.

- QUIET operation cannot be used during Dry mode. (The same is true when dry mode is selected during AUTO mode operation.)
- During Quiet operation, Heating and Cooling performance will be reduced somewhat. If the room does not warm up/cool down when using QUIET Operation, please adjust the air conditioner's Fan Speed.

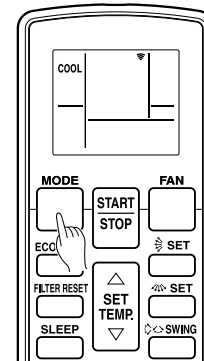

Example: When set to COOL.

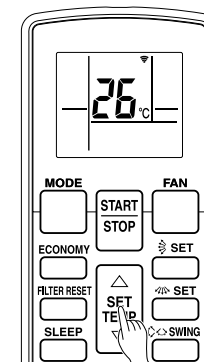

Example: When set to 26 °C.

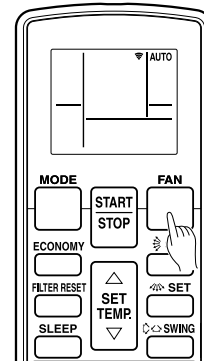

Example: When set to AUTO.

To Stop Operation

Press the **START/STOP** button.

The OPERATION Indicator Lamp (green) will go out.

About AUTO CHANGEOVER Operation

AUTO:

- When AUTO CHANGEOVER operation first selected, the fan will operate at very low speed for about one minute, during which time the unit detects the room conditions and selects the proper operating mode.

If the difference between thermostat setting and actual room temperature is more than +2 °C

→ Cooling or dry operation

(Monitor operation may be selected if the outdoor temperature is low.)

If the difference between thermostat setting and actual room temperature is within ± 2 °C

→ Monitor operation

If the difference between thermostat setting and actual room temperature is more than -2 °C

→ Heating operation

(Monitor operation may be selected if the outdoor temperature is high.)

- When the air conditioner has adjusted your room's temperature to near the thermostat setting, it will begin monitor operation. In the monitor operation mode, the fan will operate at low speed. If the room temperature subsequently changes, the air conditioner will once again select the appropriate operation (Heating, Cooling) to adjust the temperature to the value set in the thermostat.

(The monitor operation range is ± 2 °C relative to the thermostat setting.)

- If the mode automatically selected by the unit is not what you wish, select one of the mode operation (HEAT, COOL, DRY, FAN).

About Mode Operation

Heating:

- Use to warm your room.

- When Heating mode is selected, the air conditioner will operate at very low fan speed for about 3 to 5 minutes, after which it will switch to the selected fan setting. This period of time is provided to allow the indoor unit to warm up before beginning full operation.

- When the room temperature is very low, frost may form on the outside unit, and its performance may be reduced. In order to remove such frost, the unit will automatically enter the defrost cycle from time to time. During Automatic Defrosting operation, the OPERATION Indicator Lamp will flash, and the heat operation will be interrupted.

- After the start of heating operation, it takes some time before the room gets warmer.

Cooling:

- Use to cool your room.

Dry:

- Use for gently cooling while dehumidifying your room.

- You cannot heat the room during Dry mode.

- During Dry mode, the unit will operate at low speed; in order to adjust room humidity, the indoor unit's fan may stop from time to time. Also, the fan may operate at very low speed when adjusting room humidity.

- The fan speed cannot be changed manually when Dry mode has been selected.

Fan:

- Use to circulate the air throughout your room.

During Heating mode:

Set the thermostat to a temperature setting that is higher than the current room temperature. The Heating mode will not operate if the thermostat is set lower than the actual room temperature.

During Cooling/Dry mode:

Set the thermostat to a temperature setting that is lower than the current room temperature. The Cooling and Dry modes will not operate if the thermostat is set higher than the actual room temperature (in Cooling mode, the fan alone will operate).

During Fan mode:

You can not use the unit to heat and cool your room.

TIMER OPERATION

Before using the timer function, be sure that the Remote Controller is set to the correct current time (see P. 4).
If the indoor unit is connected to a Wired Remote Controller, the Wireless Remote Controller cannot be used to set the timer.

To Use the ON timer or OFF timer

- 1 Press the START/STOP button (if the unit is already operating, proceed to step 2).**
The indoor unit's OPERATION Indicator Lamp (green) will light.
- 2 Press the TIMER MODE button to select the OFF timer or ON timer operation.**
Each time the button is pressed the timer function changes in the following order:

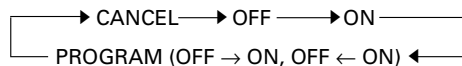

The indoor unit's orange TIMER Indicator Lamp (orange) will light.

- 3 Use the TIMER SET buttons to adjust the desired OFF time or ON time.**
Set the time while the time display is flashing (the flashing will continue for about five seconds).

- + button:** Press to advance the time.
- button:** Press to reverse the time.

About five seconds later, the entire display will reappear.

To Cancel the Timer

Use the TIMER MODE button to select "CANCEL".
The air conditioner will return to normal operation.

To Change the Timer Settings

Perform steps 2 and 3.

To Stop Air Conditioner Operation while the Timer is Operating

Press the START/STOP button.

To Change Operating Conditions

If you wish to change operating conditions (Mode, Fan Speed, Thermostat Setting, QUIET mode), after making the timer setting wait until the entire display reappears, then press the appropriate buttons to change the operating condition desired.

To Use the Program timer

- 1 Press the START/STOP button (if the unit is already operating, proceed to step 2).**
The indoor unit's OPERATION Indicator Lamp (green) will light.
- 2 Set the desired times for OFF timer and ON timer.**
See the section "To Use the ON timer or OFF timer" to set the desired mode and times.
About three seconds later, the entire display will reappear.
The indoor unit's TIMER Indicator Lamp (orange) will light.
- 3 Press the TIMER MODE button to select the PROGRAM timer operation (OFF → ON or OFF ← ON will display).**
The display will alternately show "OFF timer" and "ON timer", then change to show the time setting for the operation to occur first.
 - The program timer will begin operation. (If the ON timer has been selected to operate first, the unit will stop operating at this point.)About five seconds later, the entire display will reappear.

About the Program timer

- The program timer allows you to integrate OFF timer and ON timer operations in a single sequence. The sequence can involve one transition from OFF timer to ON timer, or from ON timer to OFF timer, within a twenty-four hour period.
- The first timer function to operate will be the one set nearest to the current time. The order of operation is indicated by the arrow in the Remote Controller's Display (OFF → ON, or OFF ← ON).
- One example of Program timer use might be to have the air conditioner automatically stop (OFF timer) after you go to sleep, then start (ON timer) automatically in the morning before you arise.

To Cancel the Timer

Use the TIMER MODE button to select "CANCEL".
The air conditioner will return to normal operation.

To Change the Timer Settings

- Follow the instructions given in the section "To Use the ON Timer or OFF Timer" to select the timer setting you wish to change.
- Press the TIMER MODE button to select either OFF → ON or OFF ← ON.

To Stop Air Conditioner Operation while the Timer is Operating

Press the START/STOP button.

To Change Operating Conditions

If you wish to change operating conditions (Mode, Fan Speed, Thermostat Setting, QUIET mode), after making the timer setting wait until the entire display reappears, then press the appropriate buttons to change the operating condition desired.

SLEEP TIMER OPERATION

Unlike other timer functions, the SLEEP timer is used to set the length of time until air conditioner operate is stopped. If the indoor unit is connected to a Wired Remote Controller, the Wireless Remote Controller cannot be used to set the sleep timer.

To Use the SLEEP Timer

While the air conditioner is operating or stopped, press the SLEEP button.

The indoor unit's OPERATION Indicator Lamp (green) lights and the TIMER Indicator Lamp (orange) light.

To Cancel the Timer:

Use the TIMER MODE button to select "CANCEL".

The air conditioner will return to normal operation.

To Change the Timer Settings

Press the SLEEP button once again and set the time using the TIMER SET (+ / -) buttons.

+ button: Press to advance the time.

- button: Press to reverse the time.

About five seconds later, the entire display will reappear.

To Stop the Air Conditioner During Timer Operation:

Press the START/STOP button.

About the SLEEP Timer

To prevent excessive warming or cooling during sleep, the SLEEP timer function automatically modifies the thermostat setting in accordance with the set time setting. When the set time has elapsed, the air conditioner completely stops.

During Heating operation:

When the SLEEP timer is set, the thermostat setting is automatically lowered 1 °C every thirty minutes. When the thermostat has been lowered a total of 4 °C, the thermostat setting at that time is maintained until the set time has elapsed, at which time the air conditioner automatically turns off.

During Cooling/Dry operation:

When the SLEEP timer is set, the thermostat setting is automatically raised 1 °C every 1 hour. When the thermostat has been raised a total of 2 °C, the thermostat setting at that time is maintained until the set time has elapsed, at which time the air conditioner automatically turns off.

SLEEP timer setting

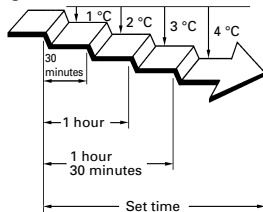

SLEEP timer setting

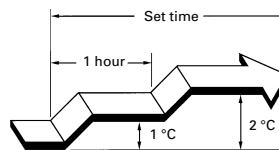

FILTER LAMP RESET

Some indoor unit models are equipped with a filter lamp in the indoor unit display to indicate when it is time to clean the air filters.

To Reset Filter Lamp

Press the FILTER RESET button.

The indoor unit's FILTER LAMP (red) will go out.

MANUAL AUTO OPERATION

Use the MANUAL AUTO operation in the event the Remote Controller is lost or otherwise unavailable.

How To Use the Main Unit Controls

Press the MANUAL AUTO button on the main unit control panel.

To stop operation, press the MANUAL AUTO button once again.

- When the air conditioner is operated with the controls on the Main unit, it will operate under the same mode as the AUTO mode selected on the Remote Controller. However, about Multi-type Air conditioner, the Heat pump model will follow the operating mode of the other indoor unit.
- The fan speed selected will be "AUTO" and the thermostat setting will be 24 °C.

ADJUSTING THE DIRECTION OF AIR CIRCULATION

Instructions relating to heating (*) are applicable only to "HEAT & COOL MODEL" (Reverse Cycle).

- Adjust the up, down, left and right AIR directions with the AIR DIRECTION buttons on the Remote Controller.
- Use the AIR DIRECTION buttons after the Indoor Unit has started operating and the airflow-direction louvers have stopped moving.

Vertical Air Direction Adjustment

Press the SET button (Vertical).

Each time the button is pressed, the air direction range will change as follows:



Types of Air flow Direction Setting:

- ①, ②, ③, ④ : During Cooling/Dry Modes
- ⑤, ⑥, ⑦ : * During Heating mode

The Remote Controller's display does not change.

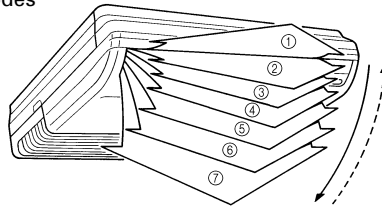

- Use the air direction adjustments within the ranges shown above.
- The vertical airflow direction is set automatically as shown, in accordance with the type of operation selected.
 - During Cooling/Dry mode : Horizontal flow ①
 - * During Heating mode : Downward flow ⑦
- During AUTO mode operation, for the first minute after beginning operation, airflow will be horizontal ①; the air direction cannot be adjusted during this period.

Horizontal Air Direction Adjustment

Press the SET button (Horizontal).

Each time the button is pressed, the air direction range will change as follows:



The Remote Controller's display does not change.

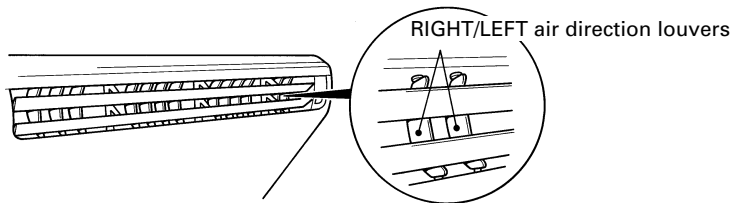

- Use the air direction adjustments within the ranges shown above.

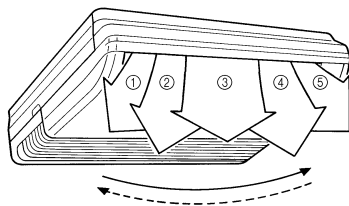

⚠ DANGER!

Never place fingers or foreign objects inside the outlet ports, since the internal fan operates at high speed and could cause personal injury.

- Attempting to move UP/DOWN air direction flaps or RIGHT/LEFT air direction louvers manually could result in improper operation; in this case, stop operation and restart. The louvers should begin to operate properly again.
- During use of the Cooling and Dry modes, do not set the UP/DOWN air direction flaps in the Heating range (⑤ to ⑦) for long periods of time, since water vapor may condense near the outlet louvers and drops of water may drip from the air conditioner. During the Cooling and Dry modes, if the Air Flow Direction Louvers are left in the heating range for more than 30 minutes, they will automatically return to position ④.
- When used in a room with infants, children, elderly or sick persons, the air direction and room temperature should be considered carefully when making settings.

SWING OPERATION

Begin air conditioner operation before performing this procedure.

To select SWING Operation

Press the SWING button.

Each time the SWING button is pressed, the swing operation will change in the following order.

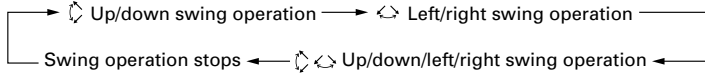

To stop SWING Operation

Press the SWING button and select STOP.

Airflow direction will return to the setting before swing was begun.

About Swing Operation

To select Up/down swing operation

The type of operation	Range of swing
Cooling/Dry	① to ④
Heating	③ to ⑦
FAN (① ~ ④) ^{*1}	① to ④
FAN (⑤ ~ ⑦) ^{*1}	③ to ⑦

^{*1} The position of the louvers before swing is given in parenthesis.

To select Left/right swing operation

The type of operation	Range of swing
Cooling/Dry	① to ⑤ (All range)
Heating	① to ⑤ (All range)
FAN	① to ⑤ (All range)

- The SWING operation may stop temporarily when the air conditioner's fan is not operating, or when operating at very low speeds.

- The SWING operation may stop temporarily when the air conditioner's fan is not operating, or when operating at very low speeds.

ECONOMY OPERATION

Begin Air Conditioner operation before performing this procedure.

To Use the ECONOMY Operation

Press the ECONOMY button.

"ECO" appears on the Remote Controller display.
Economy operation begins.

To Stop the ECONOMY Operation

Press the ECONOMY button again.

"ECO" disappears from the Remote Controller display.
Normal operation begins.

About ECONOMY Operation

In case of single-type air conditioner at the maximum output, ECONOMY Operation is approximately 70% of normal air conditioner operation for cooling and heating.

During ECONOMY operation, the thermostat setting automatically changes according to the temperature to avoid Unnecessary cooling and heating for the most economical operation.

- In that time, the airflow may be weakened or indoor fan may be stopped in sometime. If the room is not cooled (or heated) well during economy operation, select normal operation.
- Once air conditioner operation is stopped, normal operation begins when the indoor unit is turned on again.
- In case of multi-type air conditioner, the economy operation mode is only available for the set indoor unit.

CLEANING AND CARE

CAUTION!

- Before cleaning the air conditioner, be sure to turn it off and disconnect the power supply cable.
- Be sure the intake grille is installed securely.
- When removing and replacing the air filters, be sure not to touch the heat exchanger, as personal injury may result.

Cleaning the Air Filter

When the **FILTER Lamp** is blinking, remove the filter and clean it.

1. Pull out both sides and the center of the intake grille.

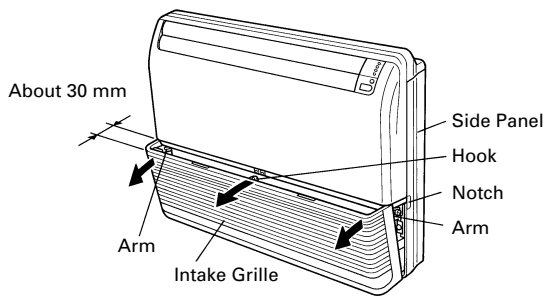

2. Pull the air filters upward to remove them.

Push the air filter handles away from the intake grille in direction ①, then pull out the air filters.

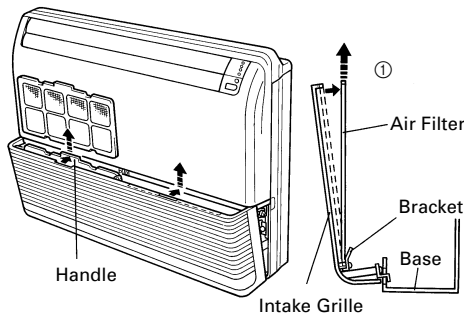

3. Clean the air filters.

Remove the dust from the air filters by vacuuming or washing them. After washing, allow the air filters to dry thoroughly in an area protected from sunlight.

- When used for extended periods, the unit may accumulate dirt inside, reducing its performance. We recommend that the unit be inspected regularly, in addition to your own cleaning and care. For more information, consult authorized service personnel.
- When cleaning the unit's body, do not use water hotter than 40 °C, harsh abrasive cleansers, or volatile agents like benzene or thinner.
- Do not expose the unit body to liquid insecticides or hairsprays.
- If the unit will not be operated for a period of one month or more, be sure to allow the inner parts of the unit to dry thoroughly, in advance, by operating the unit in fan mode for half a day.

4. Re-attach the air filters to the intake grille.

- ① The air filters fit onto the inside of the intake grille. (Figure 1)
- ② The bottom edges of the air filters should fit into the filter brackets. (Figure 1)
- ③ The air filters should be pushed down so that their top edges fit under the projections at the top of the intake grille. (Figure 2)

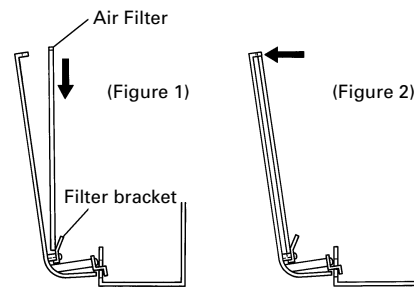

5. Push in both sides and the center of the intake grille.

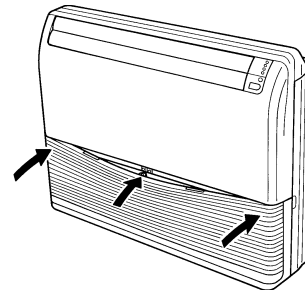

- Dust can be cleaned from the air filter either with a vacuum cleaner, or by washing the filter in a solution of mild detergent and warm water. If you wash the filter, be sure to allow it to dry thoroughly in a shady place before re-installing.
- If dirt is allowed to accumulate on the air filter, air flow will be reduced, lowering operating efficiency and increasing noise.
- After turning the power on, press the filter button on the Remote Controller to turn off the filter lamp.

SELECTING THE REMOTE CONTROLLER SIGNAL CODE

When two or more air conditioners are installed in a room and the Remote Controller is operating an air conditioner other than the one you wish to set, change the signal code of the Remote Controller to operate only the air conditioner you wish to set (four selections possible).

When two or more air conditioners are installed in a room, please contact your retailer to set the individual air conditioner signal codes.

Selecting the Remote Controller Signal Code

Use the following steps to select the signal code of the Remote Controller. (Note that the air conditioner cannot receive a signal code if the air conditioner has not been set for the signal code.)

- 1** Press the **START/STOP** button until only the clock is displayed on the Remote Controller display.
- 2** Press the **MODE** button for at least five seconds to display the current signal code (initially set to **A**).
- 3** Press the **+** / **-** buttons to change the signal code between **A**→**b**→**c**→**d**. Match the code on the display to the air conditioner signal code.
- 4** Press the **MODE** button again to return to the clock display. The signal code will be changed.

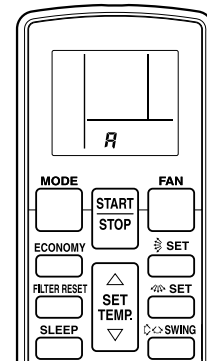

If no buttons are pressed within 30 seconds after the signal code is displayed, the system returns to the original clock display. In this case, start again from step 1.

The air conditioner signal code is set to A prior to shipment. Contact your retailer to change the signal code.

The Remote Controller resets to signal code A when the batteries in the Remote Controller are replaced. If you use a signal code other than signal code A, reset the signal code after replacing the batteries. If you do not know the air conditioner signal code setting, try each of the signal codes (**A**→**b**→**c**→**d**) until you find the code which operates the air conditioner.

TROUBLESHOOTING

Instructions relating to heating (*) are applicable only to "HEAT & COOL MODEL" (Reverse Cycle).

WARNING!

In the event of a malfunction (burning smell, etc.), immediately stop operation, disconnect the power supply plug or turn off the circuit breaker, and consult authorized service personnel. Merely turning off the unit's power switch will not completely disconnect the unit from the power source. Always be sure to disconnect the power supply plug or turn off your circuit breaker to ensure that power is completely off.

Before requesting service, perform the following checks:

	Symptom	Problem	See page
NORMAL FUNCTION	Doesn't operate immediately:	<ul style="list-style-type: none"> ● If the unit is stopped and then immediately started again, the compressor will not operate for about 3 minutes, in order to prevent fuse blowouts. ● Whenever the power supply plug is disconnected and then reconnected to a power outlet, the protection circuit will operate for about 3 minutes, preventing unit operation during that period. 	—
	Noise is heard:	<ul style="list-style-type: none"> ● During operation and immediately after stopping the unit, the sound of water flowing in the air conditioner's piping may be heard. Also, noise may be particularly noticeable for about 2 to 3 minutes after starting operation (sound of coolant flowing). ● During operation, a slight squeaking sound may be heard. This is the result of minute expansion and contraction of the front cover due to temperature changes. 	—
		<ul style="list-style-type: none"> *● During Heating operation, a sizzling sound may be heard occasionally. This sound is produced by the Automatic Defrosting operation. 	14

TROUBLESHOOTING

Instructions relating to heating (*) are applicable only to "HEAT & COOL MODEL" (Reverse Cycle).

	Symptom	Problem	See page
NORMAL FUNCTION	Smells:	<ul style="list-style-type: none"> ● Some smell may be emitted from the indoor unit. This smell is the result of room smells (furniture, tobacco, etc.) which have been taken into the air conditioner. 	—
	Mist or steam are emitted:	<ul style="list-style-type: none"> ● During Cooling or Dry operation, a thin mist may be seen emitted from the indoor unit. This results from the sudden Cooling of room air by the air emitted from the air conditioner, resulting in condensation and misting. 	—
		<ul style="list-style-type: none"> *● During Heating operation, the outdoor unit's fan may stop, and steam may be seen rising from the unit. This is due to the Automatic Defrosting operation. 	14
	Airflow is weak or stops:	<ul style="list-style-type: none"> *● When Heating operation is started, fan speed is temporarily very low, to allow internal parts to warm up. *● During Heating operation, if the room temperature rises above the thermostat setting, the outdoor unit will stop, and the indoor unit will operate at very low fan speed. If you wish to warm the room further, set the thermostat to a higher setting. 	—
		<ul style="list-style-type: none"> *● During Heating operation, the unit will temporarily stop operation (between 7 and 15 minutes) as the Automatic Defrosting mode operates. During the Automatic Defrosting operation, the OPERATION indicator lamp will flash. 	14
		<ul style="list-style-type: none"> ● The fan may operate at very low speed during Dry operation or when the unit is monitoring the room's temperature. 	—
		<ul style="list-style-type: none"> ● In case of Multi-type unit, if multiple units are operated in different operation modes as shown below, the units operated afterward will stop and  will be shown on the Remote Controller display of the stopped indoor units. Heating mode and cooling mode (or dry mode) Heating mode and fan mode 	16
		<ul style="list-style-type: none"> ● During QUIET operation, the fan will operate at very low speed. 	—
		<ul style="list-style-type: none"> ● In the monitor AUTO operation, the fan will operate at very low speed. 	—
	Water is produced from the outdoor unit:	<ul style="list-style-type: none"> *● During Heating operation, water may be produced from the outdoor unit due to the Automatic Defrosting operation. 	14
The FILTER lamp blinks:	<ul style="list-style-type: none"> ● Clean the filter. Afterwards, turn the FILTER lamp off. 	8	
CHECK ONCE MORE	Doesn't operate at all:	<ul style="list-style-type: none"> ● Has the circuit breaker been turned off? ● Has there been a power failure? ● Has a fuse blown out, or a circuit breaker been tripped? 	—
		<ul style="list-style-type: none"> ● Is the timer operating? 	7 to 8
	Poor Cooling (or *Heating) performance:	<ul style="list-style-type: none"> ● Is the air filter dirty? ● Are the air conditioner's intake grille or outlet port blocked? ● Did you adjust the room temperature settings (thermostat) correctly? ● Is there a window or door open? ● In the case of Cooling operation, is a window allowing bright sunlight to enter? (Close the curtains.) ● In the case of Cooling operation, are there heating apparatus and computers inside the room, or are there too many people in the room? 	—
		<ul style="list-style-type: none"> ● Is the unit set for QUIET operation? 	—
	The unit operates differently from the Remote Controller's setting:	<ul style="list-style-type: none"> ● Are the Remote Controller's batteries dead? ● Are the Remote Controller's batteries loaded properly? 	4
Signal is not received after replacing the batteries for the Remote Controller:	<ul style="list-style-type: none"> ● Are you using an air conditioner signal code other than signal code A? 	12	

If the problem persists after performing these checks, or if you notice burning smells, or the TIMER indicator lamp and operation indicator lamp flashes, stop operation immediately, turn off electric breaker, and consult with authorized service personnel.

OPERATING TIPS

Instructions relating to heating (*) are applicable only to "HEAT & COOL MODEL" (Reverse Cycle).

*Heating Performance

- This air conditioner operates on the heat-pump principle, absorbing heat from outdoor air and transferring that heat indoors. As a result, the operating performance is reduced as outdoor air temperature drops. If you feel that insufficient heating performance is being produced, we recommend you use this air conditioner in conjunction with another kind of heating appliance.
- Heat-pump air conditioners heat your entire room by recirculating air throughout the room, with the result that some time may be required after first starting the air conditioner until the room is heated.

*When Indoor and Outdoor Temperature are High

- When both indoor and outdoor temperatures are high during use of the heating mode, the outdoor unit's fan may stop at times.

*Microcomputer-controlled Automatic Defrosting

- When using the Heating mode under conditions of low outdoor temperature and high humidity, frost may form on the outdoor unit, resulting in reduced operating performance.
In order to prevent this kind of reduced performance, this unit is equipped with a Microcomputer-controlled Automatic Defrosting function. If frost forms, the air conditioner will temporarily stop, and the defrosting circuit will operate briefly (for about 4 to 15 minutes).
During Automatic Defrosting operation, the OPERATION indicator lamp (green) will flash.
- After heating operation stops, if frost forms on the outdoor unit, the unit will start Automatic Defrosting operation.
At this time, the outdoor unit will automatically stop after operating for a few minutes.
(However, some type of multi-type air conditioner doesn't provide this function.)

*Low Ambient Cooling

- When the outdoor temperature drops, the outdoor unit's fans may switch to Low Speed.

Mode operation: AUTO

COOLING MODEL

- When the room temperature is 2 °C higher than the set temperature, the mode will switch between Cooling and Drying.

HEAT & COOL MODEL (Reverse Cycle)

Auto changeover function

- When AUTO CHANGEOVER is selected, the air conditioner selects the appropriate operation mode (Cooling or Heating) according to your room's present temperature.
- When AUTO CHANGEOVER is first selected, the fan will operate at a very low speed for about 1 minute while the unit determines the current conditions of the room and selects the proper operation mode.

If the difference between thermostat setting and actual room temperature is more than +2 °C

→ Cooling or dry operation

(Monitor operation may be selected if the outdoor temperature is low.)

If the difference between thermostat setting and actual room temperature is within ±2 °C

→ Monitor operation

If the difference between thermostat setting and actual room temperature is more than -2 °C

→ Heating operation

(Monitor operation may be selected if the outdoor temperature is high.)

- During the Drying mode operation, the FAN setting should be switched to LOW for a gently cooling effect during which the fan may temporarily stop rotating.

- When the room temperature is near the thermostat setting, the air conditioner will begin monitor operation. In the monitor operation mode, the fan will operate at a very low speed. If the room temperature subsequently changes, the air conditioner will once again select the appropriate operation (Heating or Cooling) to adjust the temperature to the value set in the thermostat. (The monitor operation range is ±2 °C relative to the thermostat setting.)

OPERATING TIPS

About Mode Operation

Heating: ● Use to warm your room.

- When Heating mode is selected, the air conditioner will operate at very low fan speed for about 3 to 5 minutes, after which it will switch to the selected fan setting. This period of time is provided to allow the indoor unit to warm up before beginning full operation.
- When the room temperature is very low, frost may form on the outside unit, and its performance may be reduced. In order to remove such frost, the unit will automatically enter the defrost cycle from time to time. During Automatic Defrosting operation, the OPERATION indicator Lamp will flash, and the heat operation will be interrupted.
- After the start of heating operation, it takes sometime before the room gets warmer.

Cooling: ● Use to cool your room.

- Dry:**
- Use for gently cooling while dehumidifying your room.
 - You cannot heat the room during Dry mode.
 - During Dry mode, the unit will operate at low speed; in order to adjust room humidity, the indoor unit's fan may stop from time to time. Also, the fan may operate at very low speed when adjusting room humidity.
 - The fan speed cannot be changed manually when Dry mode has been selected.

Fan: ● Use to circulate the air throughout your room.

During Heating mode:

Set the thermostat to a temperature setting that is higher than the current room temperature. The Heating mode will not operate if the thermostat is set lower than the actual room temperature.

During Cooling/Dry mode:

Set the thermostat to a temperature setting that is lower than the current room temperature. The Cooling and Dry modes will not operate if the thermostat is set higher than the actual room temperature (in Cooling mode, the fan alone will operate).

During Fan mode:

You can not use the unit to heat and cool your room.

AUTO Restart

In Event of Power Interruption

- Should the power supply to the air conditioner be interrupted by a power failure, the air conditioner will restart automatically in the previously selected mode once the power is restored.
- Should a power failure occur during TIMER operation, the timer will be reset and the unit will begin (or stop) operating under the new timer setting. In this event, the TIMER indicator lamp (orange) will flash.
- Use of other electrical appliances (electric shaver, etc.) or nearby use of a wireless radio transmitter may cause the air conditioner to malfunction. In this event, temporarily disconnect the power supply plug, reconnect it, and then use the Remote Controller to resume operation.

Multi-type Air conditioner

This indoor unit can be connected to a multi-type outdoor unit. The multi-type air conditioner allows multiple indoor units to be operated in multiple locations. The indoor units may be operated simultaneously, in accordance with their respective output.

Simultaneous Use of Multiple Units

Instructions relating to inverter (*) are applicable only to "INVERTER MODEL".

- When using a multi-type air conditioner, the multiple indoor units can be operated simultaneously, but when two or more indoor units of the same group are operated simultaneously, the heating and cooling efficiency will be less than when a single indoor unit is used alone. Accordingly, when you wish to use more than one indoor unit for cooling at the same time, the use should be concentrated at night and other times when less output is required. In the same way, when multiple units are used simultaneously for heating, it is recommended that they be used in conjunction with other auxiliary space heaters, as required.
- Seasonal and outdoor temperature conditions, the structure of the rooms and the number of persons present may also result in differences of operating efficiency. We recommend that you try various operating patterns in order to confirm the level of heating and cooling output provided by your units, and use the units in the way that best matches your family's lifestyle.
- If you discover that one or more units delivers a low level of cooling or heating during simultaneous operation, we recommend that you stop simultaneous operation of the multiple units.
- ✦ ● Operation cannot be done in the following different operating modes.
If the indoor unit is instructed to do an operating mode that it cannot perform, the OPERATION indicator lamp (green) on the indoor unit will flash (1 second on, 1 second off) and the unit will go into the standby mode.
 - Heating mode and cooling mode (or dry mode)
 - Heating mode and fan mode
- ✦ ● Operation can be done in the following different operating modes.
 - Cooling mode and dry mode
 - Cooling mode and fan mode
 - Dry mode and fan mode
- ✦ ● The operating mode (heating mode or cooling (dry) mode) of the outdoor unit will be determined by the operating mode of the indoor unit that was operated first. If the indoor unit was started in fan mode, the operating mode of the outdoor unit will not be determined.
For example, if indoor unit (A) was started in fan mode and then indoor unit (B) was then operated in heating mode, indoor unit (A) would temporarily start operation in fan mode but when indoor unit (B) started operating in heating mode, the OPERATION indicator lamp (green) for indoor unit (A) would begin to flash (1 second on, 1 second off) and it would go into standby mode. Indoor unit (B) would continue to operate in heating mode.

Notice

Instructions relating to heating (*) are applicable only to "HEAT & COOL MODEL" (Reverse Cycle).

- *● During use of the heating mode, the outdoor unit will occasionally commence the defrost operation for brief periods. During the defrosting operation, if the user sets the indoor unit for heating again, the defrosting mode will continue, and the heating operation will begin after completion of defrosting, with the result that some time may be required before warm air is emitted.
- *● During use of the heating mode, the top of the indoor unit may become warm, but this is due to the fact that coolant is circulated through the indoor unit even when it is stopped; it is not a malfunction.

TEMPERATURE AND HUMIDITY RANGE

Permissible ranges of temperature and humidity are as follows:

		Inverter Single Model	Inverter Multi Model
Cooling/Dry Operation	Outdoor temperature	About -10 °C to 46 °C	About 0 °C to 46 °C
	Indoor temperature	About 18 °C to 32 °C	About 18 °C to 32 °C
	Indoor humidity	Below approximately 80%. If the air conditioner is used continuously for many hours, water may condense on the surface and drip.	
Heating Operation	Outdoor temperature	About -15 °C to 24 °C	About -10 °C to 24 °C
	Indoor temperature	About below 30 °C	About below 30 °C

If the unit is used under higher temperature conditions than those noted here, the automatic protection circuit may operate, interrupting the operation.

If the unit is used under lower temperature conditions than those noted here, the heat exchanger may freeze, causing water leakage or other malfunction.

- Do not use the air conditioner for any purpose other than room cooling/dry, room heating or fan.





FUJITSU GENERAL LIMITED
1116, Suenaga, Takatsu-ku, Kawasaki 213-8502, Japan