



OPERATION MANUAL

AIR CONDITIONER

DUCT TYPE

Indoor Unit

Model

CDS25R

CDS36R

CDS45R

CDS54R

Outdoor Unit

Model

AOT25R

AOT36R

AOT45R

AOT54R

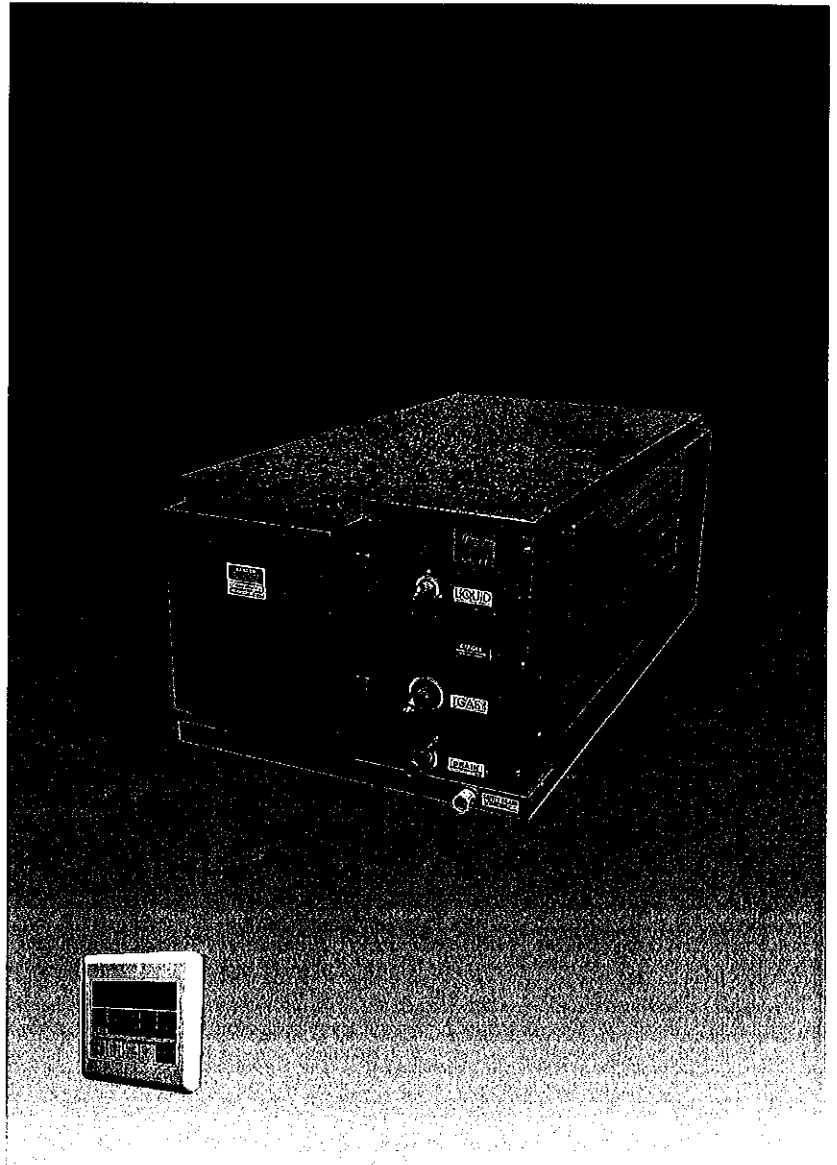

**KEEP THIS MANUAL FOR
FUTURE REFERENCE**



FUJITSU GENERAL (AUST.) PTY LIMITED

A.B.N. 55001229554

Sydney (02) 8822 2500
Brisbane (07) 3367 2008
Perth (08) 9345 2011

Melbourne (03) 9510 8652
Adelaide (08) 8364 0588
New Zealand (64) 4568 8761

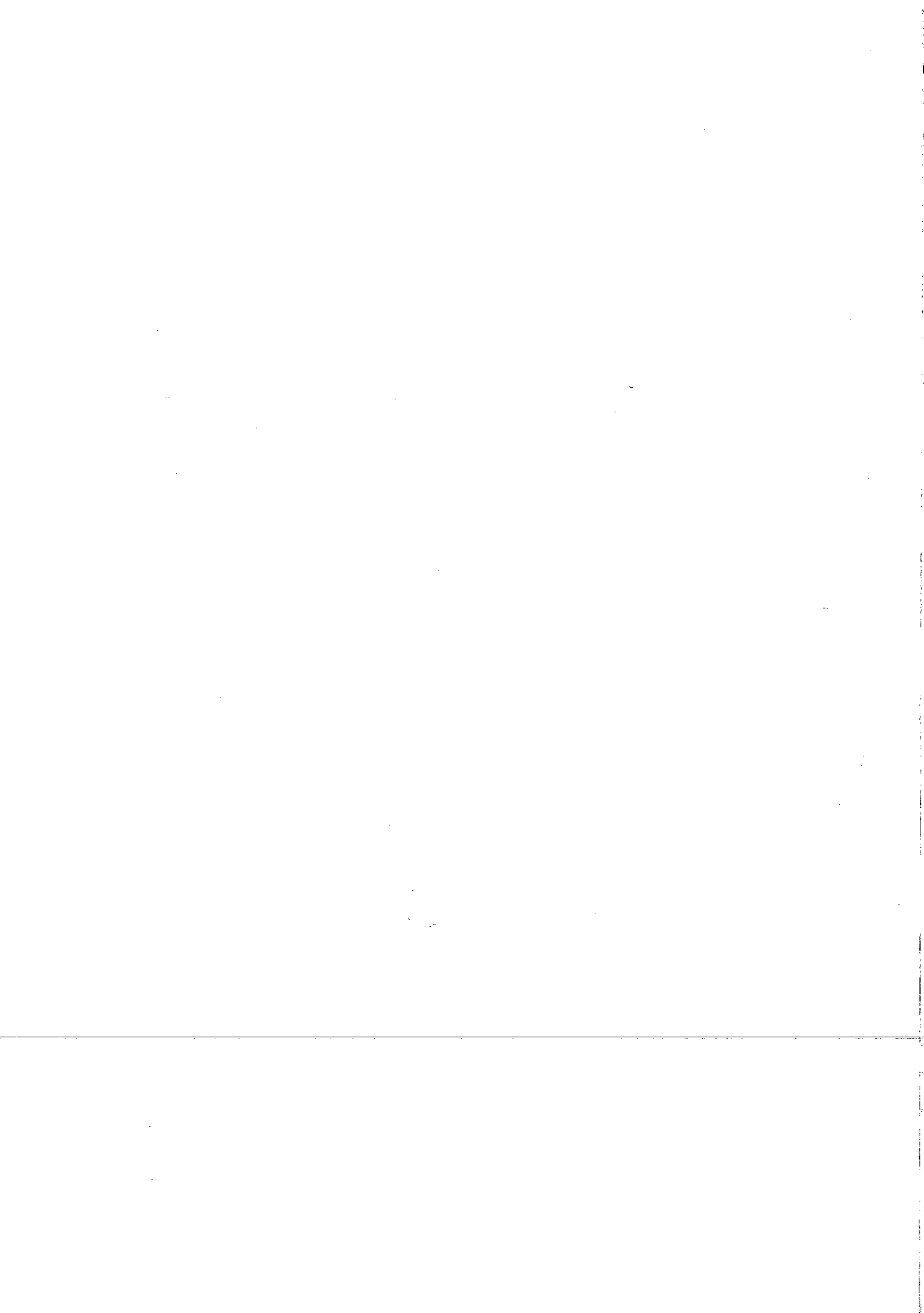



CONTENTS



PRECAUTIONS.....	2-5	DEFROST AND ENERGY SAVE.....	12
SYSTEM DESCRIPTION.....	6	CARE AND MAINTENANCE.....	13
REMOTE CONTROLLER.....	7	ERRORS AND SELF DIAGNOSIS.....	14
SYSTEM OPERATION.....	8	TROUBLE SHOOTING.....	15
MODE OPERATION (COOL,HEAT).....	9	SPECIFICATIONS.....	16
OPERATION (FAN,AUTO ZONE).....	10		
TIMER OPERATION.....	11		

PRECAUTIONS

- Before operating the air conditioner, read and understand this manual thoroughly.
- The instructions in this section all relate to safety; be sure to maintain safe operating conditions.
- “CAUTION” and “WARNING” have the following meanings in these instructions:
- This air conditioner is part of a complete system provided by your installer.

	WARNING!	This mark indicates procedures which, if improperly performed, might lead to death or serious injury.
	CAUTION!	This mark indicates procedures which, if improperly performed, might possibly result in personal harm to the user, or others or damage to property.

Safety Symbols

-  The triangular symbol indicates WARNING and CAUTION items.
-  This symbol indicates prohibited operations. The prohibited action is indicated both within the symbol, and in nearby explanations.
-  This symbol indicates instructions regarding operation of the system.

DANGER

Do not attempt to install this air conditioner by yourself.

- Consult authorised personnel for all installations.



Consult authorised personnel for any repairs.

- Do not attempt to remove parts, or service the unit yourself, since you may be exposed to dangerous electrical shock. This appliance contains no other serviceable parts. (Except air filters)
- Handling of refrigerants is now restricted only to licenced persons



Consult authorised personnel for disconnection and reinstallation.



PRECAUTIONS cont.



DANGER

Do not stay in direct cooling airflow for long periods of time.

- Excessive direct exposure to chilled air could be bad for your health.
- Be especially careful when going to bed, and in rooms where infants, aged, or sick people are staying. Make sure that airflow is not direct on persons.



Do not insert fingers or objects into the outlet port or intake grilles.

- A fan operates at high speed inside the unit, and personal injury could result.
- Be particularly careful regarding small children, extra protection maybe required.



Do not start and stop air conditioner operation by turning off the electrical circuit breaker or isolation switch.



In the event of a malfunction (burning smell, etc.), immediately stop operation. Turn off the electrical breaker and consult authorised service personnel.

- Continuing to operate the unit under such conditions could lead to hazard of fire or electrical shock.



PRECAUTIONS cont.



CAUTION

Provide ventilation during use.

- Be careful to provide adequate ventilation particularly when using the unit in combination with other heating apparatus.
- Insufficient ventilation could lead to oxygen starvation.

Do not direct airflow at fireplaces or heating apparatus.

- Direct air blowing on fires could result in improper combustion or fire.

Do not climb on, or place objects on, the outdoor air conditioner.

- Personal injury could result from a falling object, or if the unit tips over.
- Do not climb on the air conditioner.
- Do not place a cover over the air conditioner when operating it.

Do not operate the air conditioner with wet hands.

- An electrical shock could result.

Do not expose the internal components of the air conditioner directly to water.

- Electrical insulation could be damaged, resulting in electrical shock or fire.
- Outdoor units are designed for exposure to rain etc. and do not require covers.

Always turn off the electrical breaker whenever cleaning the air conditioner or changing the air filter.

- A fan operates at high speed inside the unit, and personal injury could result.

Turn off power source when not using the unit for extended periods.

- Switch off when cleaning the filter.

Check the condition of the installation for damage or faults.

- Arrange for periodical visits by authorised service personnel to check installation condition.

Connection valves become hot during Heating – Handle with care.

- Touching the connection valves could result in burns.

When restarting after a long period of disuse in the winter, you should:

- Turn the power switch on at least 12 hours before starting the unit; this will help the unit run more smoothly and for a longer time.

Do not place animals or plants in the direct path of the airflow.

- Lengthy exposure to direct Heating or Cooling airflow could have adverse influence on plants or animals.

PRECAUTIONS cont.



CAUTION

Do not drink the water drained from the air conditioner.

- Do not let children or others or animals drink the water.

Do not use in applications involving the storage of food, plants or animals, precision equipment, or art works.

- The quality of the stored items may deteriorate.
- This system provides comfort conditions only and is not designed for accurate temperature control.

Always operate with the air filter installed.

- Operating the unit without the air filter could cause excessive dirt to collect on internal parts, leading to malfunction.

Do not touch the heat exchanger radiator fins.

- Personal injury could result.
- Be particularly careful when cleaning.
- Bending or damage to the fins will affect the efficiency, of the unit.

Install the remote control unit at least one metre from any television sets or radios.

Do not block or cover the intake grille and outlets.

- Obstructing the outlets will reduce operating efficiency, leading to improper operation and possible damage.

When installing the indoor unit and outdoor unit, take precautions to prevent access by infants.

- Unexpected accidents and injury could occur.

When not using the unit for extended periods, turn OFF the electrical breaker or isolator for safety.

Do not use inflammable gases near the air conditioner.

- Or where flammable gas or fumes can be drawn into the air conditioner.

Keep the return air filter clean to prevent malfunction.

SYSTEM DESCRIPTION

SINGLE PHASE OUTDOOR UNIT

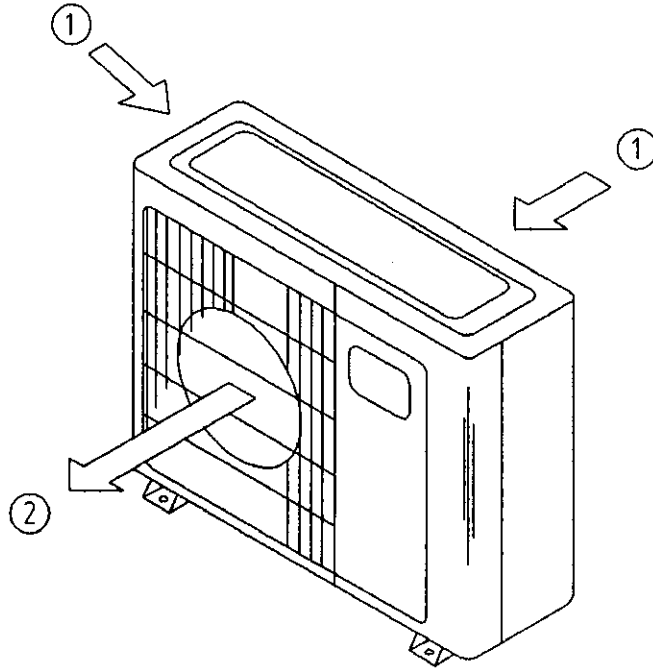

① **Air inlet**
Outside air is taken in.

② **Air outlet**
Warm and cool air is blown out.

THREE PHASE OUTDOOR UNIT

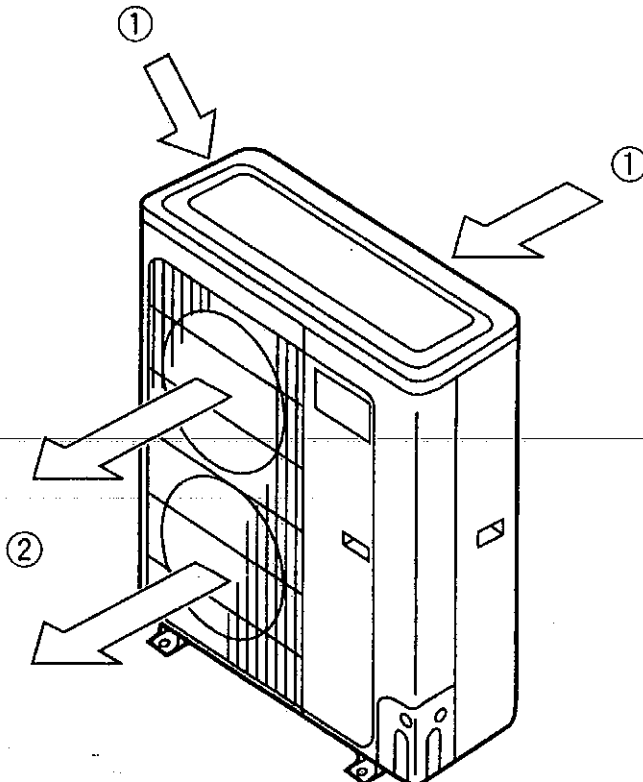

REMOTE CONTROLLER

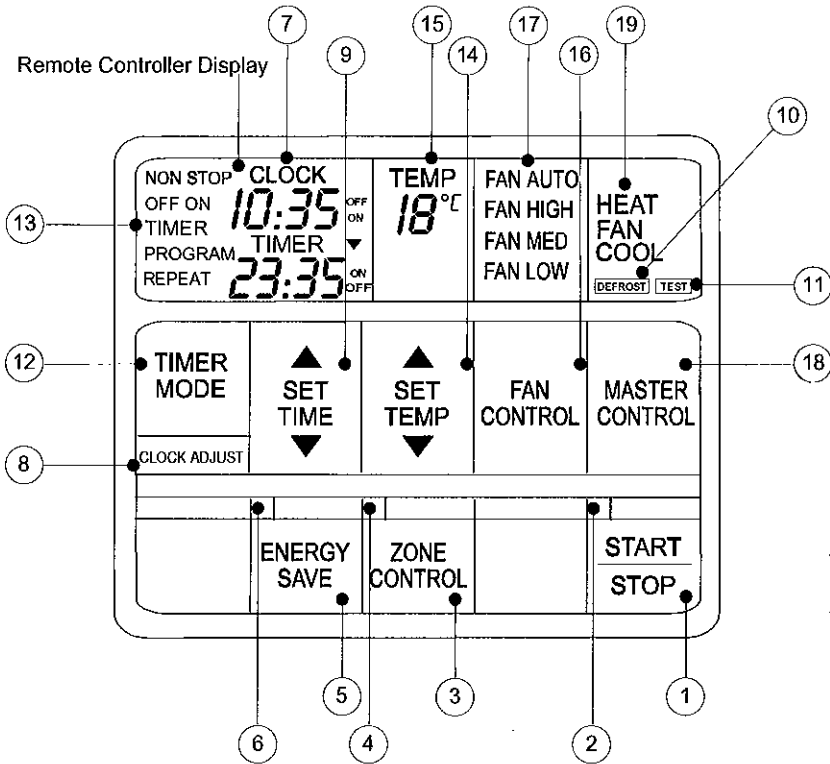

* For explanatory purposes, the figure showing the remote controller display shows all possible displays. The actual display during operation shows only in that area that is being adjusted or used.

1	START/STOP Button Start and stop operation	12	TIMER MODE Button Change timer modes (NON STOP, OFF TIMER, ON TIMER, PROGRAM TIMER, REPEAT TIMER).
2	Operation Light Lights up during operation and when the timer is on.	13	Timer Mode Display Displays the timer mode (NON STOP, OFF TIMER, ON TIMER, PROGRAM, REPEAT).
3	ZONE CONTROL Button Turn the zone control on and off.	14	SET TEMP. Button (▲/▼) Change the temperature setting.
4	ZONE CONTROL Lamp Lights up when the unit is in the zone control mode.	15	Set Temperature Display (TEMP.) Displays the set temperature. Depending on the usage circumstances of the unit (room width, outdoor temperature etc.), the displayed temperature may differ from the actual room temperature.
5	ENERGY SAVE Button Turns the energy efficient mode on and off.	16	FAN CONTROL Button Select the fan speed (AUTO, HIGH, MED, LOW)
6	ENERGY SAVE Lamp Lights up when the unit is in the energy save mode.	17	Fan Speed Display Displays the current fan speed
7	Clock Display (CLOCK/TIMER) Displays current or timer times (0:00 to 23:59).	18	MASTER CONTROL Button Select the various operating modes (HEAT, FAN, COOL).
8	CLOCK ADJUST Button	19	Operation Mode Display Displays the operating mode (HEAT, FAN, COOL)
9	SET TIME Button (▲/▼) Change the timer settings and set the current time		
10	DEFROST Display Displayed during defrosting		
11	TEST Display Displayed during test operation		

NOTES:

1. The system can be controlled in different ways. Two remote controllers may be connected to one air conditioner. The air conditioner operation will be controlled by the last settings. (Both remote controllers show the same display).

2. One remote controller can control up to 16 air conditioners. All the air conditioners can be operated with the same setting.

SYSTEM OPERATION

PREPARATION

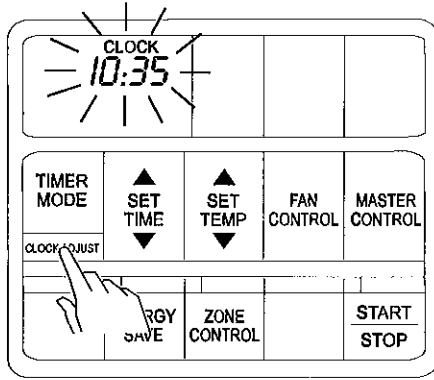

SET THE CURRENT TIME

Step 1

Press **CLOCK ADJUST** button for more than three seconds. The current time display will flash.

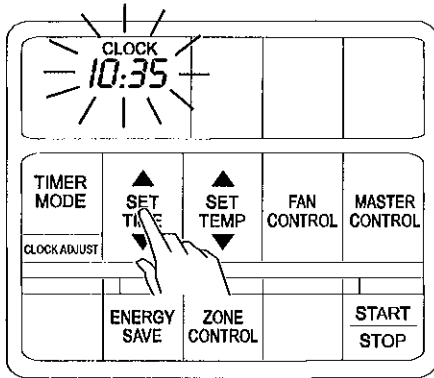

Step 2

Press the **SET TIME** button and set the time by using the ▲ to advance time forward and the ▼ to turn time back. Press once to move the time 1minute. Hold down and the time will move 10 minutes at a time.

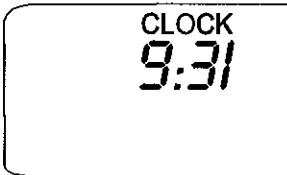

Example: Set the time to 9:31

Step 3

Press **CLOCK ADJUST** button again. The current time display will stop flashing.

START THE SYSTEM

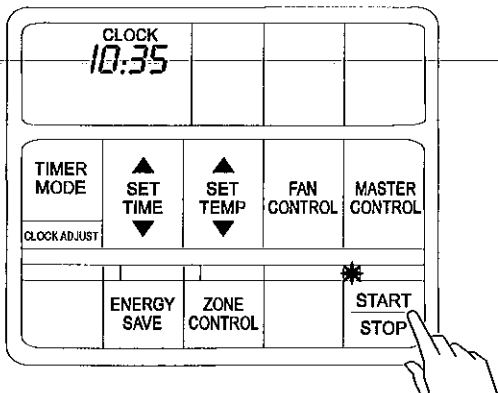

Press the **START/STOP** button. The unit will start and the operation-lamp-above-the-START/STOP-button-will light up. This operation lamp will remain lit while the unit is operating.

MODE OPERATION – COOLING AND HEATING

SELECT THE MODE – COOL OR HEAT

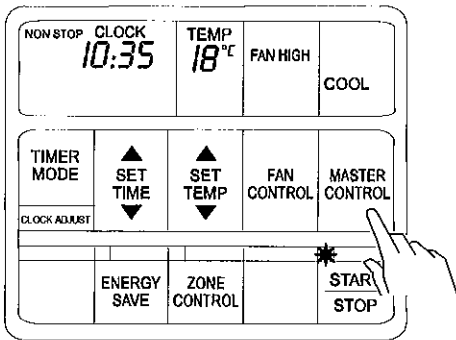

Press the MASTER CONTROL button. Select either HEAT or COOL.

NOTE:

During defrosting mode, the heating mode will be temporarily interrupted. DEFROST will be shown on the remote controller display.

SET THE TEMPERATURE

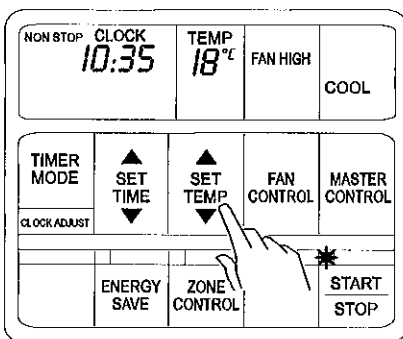

To set the temperature press ▲ or ▼ on the SET TEMP button.

Press ▲ to raise the set temperature (Press the button once to raise the temperature by 1°C). Press ▼ to lower the set temperature (Press the button once to lower the temperature by 1°C).

NOTE:

1. For HEATING mode the minimum temperature setting is 16°C and the maximum temperature setting indication is 30°C.
2. For COOLING mode the minimum temperature setting is 18°C and the maximum temperature setting indication is 30°C.
3. While in HEATING mode, set the temperature higher than the current room temperature. If it is

set lower than the current room temperature, heating will not start.

4. While in COOLING mode set the temperature lower than the current room temperature. If it is set higher than the current room temperature, the unit will not enter the cooling mode and only the fan will operate.

SELECT THE FAN SPEED

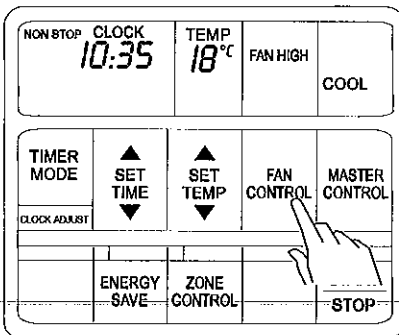

Press the FAN CONTROL BUTTON to select the fan speed (LOW, MEDIUM, HIGH).

Every time the FAN CONTROL button is pressed the speed changes as shown:

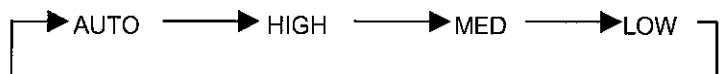

ABOUT MODE OPERATION:

1. When the AUTO fan speed is selected in the heating or cooling modes, the fan speed will vary with room conditions.
2. The final fan speed and the variation between speeds will depend on the ductwork system installed.
3. For about 3 to 5 minutes after the start of the heating cycle, the indoor fan may be stopped or operate at a slow speed, then switch to the

selected fan setting. This period allow the indoor unit's heat exchanger to perform before emitting warm air.

4. When both indoor and outdoor temperatures are high during heating mode, the outdoor unit's fan may stop at times.
5. When the outdoor temperature drops during cooling, the outdoor unit's fans may switch to LOW speed, or one of the fans may stop intermittently.

OPERATION

FAN ONLY OPERATION

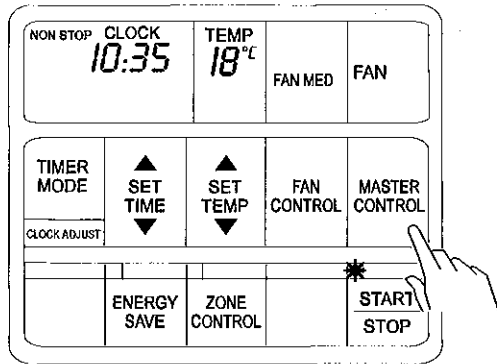

First start the system. Then press the MASTER CONTROL button until **FAN** is indicated. Select the required fan speed.

NOTE:

1. When the AUTO fan speed is selected in the FAN mode, the fan speed will automatically be set on MED.
2. The room temperature cannot be adjusted in the FAN mode. The temperature is not displayed on the remote.

AUTO RESTART

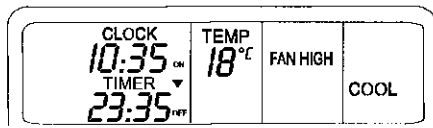

When a power failure, etc. temporarily interrupts the air conditioner power supply, the system will automatically restart after the power recovers. The operation settings prior to the power failure will appear on the controller.

ZONE CONTROL

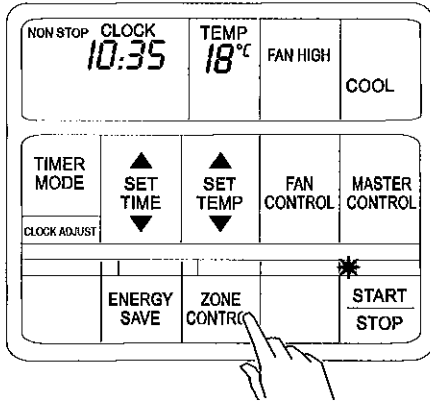

When the ZONE CONTROL button is pressed while multiple air conditioners are being centrally controlled, only the pre-set air conditioners stop.

Press the ZONE CONTROL button. Pre-set units will stop.

To stop zone control, press the ZONE CONTROL button one more time. Those units that were stopped will start again.

SHUTTING DOWN THE SYSTEM

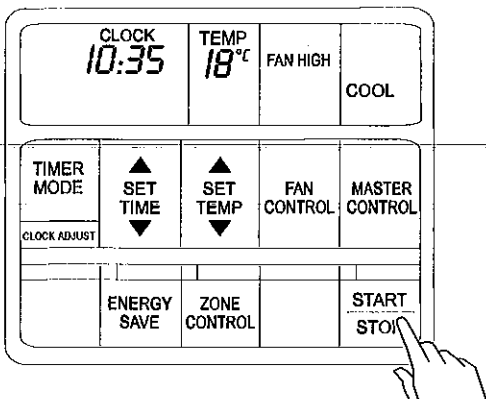

Press the START/STOP button. The unit will stop operating. The operation lamp above the START/STOP button will no longer be lit.

TIMER OPERATION

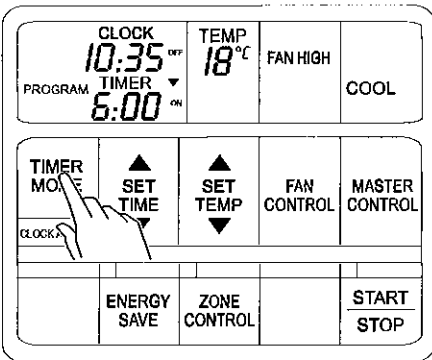
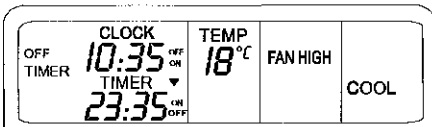
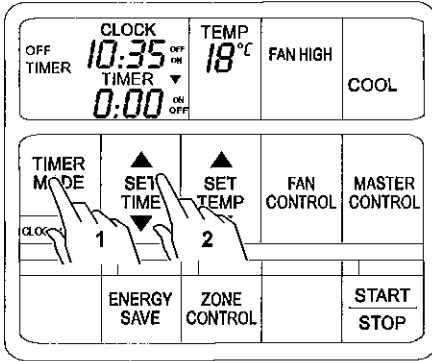

Press the START/STOP button.

Step 1

Press the TIMER MODE button to display either OFF or ON Timer. The timer will start operating. If you set the ON timer, the air conditioner will stop operating.

Each time the button is pressed the timer function changes in the following order:

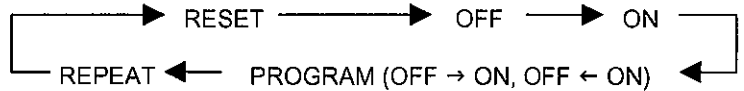

Step 2

Press the SET TIME button to set the timer time. Use ▲ and ▼ to move time back or forward as required. Press once to move the time by 1 minute or hold SET TIME button down and the time will move 10 minutes at a time.

PROGRAM TIMER AND REPEAT TIMER

Set the timer time. Follow steps 1 and 2 and set the times for the ON timer and OFF timer modes.

Press the TIMER MODE button until the PROGRAM or REPEAT mode is displayed.

Program timer

- Combines the OFF timer and the ON timer for one cycle (OFF→ON, or OFF←ON).
- Starts operation from the OFF timer or the ON timer, whichever is closer to the current time.

Repeat timer

- Combines the operation of the OFF timer and the ON timer (the cycle described in the PROGRAM timer above) so they repeat at the same cycle every day.
- Starts operation from the OFF timer or the ON timer, whichever is closer to the current time.

TO CONFIRM OR CHANGE TIMER SETTINGS BEFORE STARTING OPERATION

■ To confirm settings

Press the TIMER MODE button once. The timer setting information will be displayed for 15 seconds after the TIMER MODE button is pressed.

■ To change settings

Confirm the settings as above. Press the SET TIME button and TIMER MODE button as necessary to change the desired timer setting. The timer setting information will be displayed for 15 seconds after the TIMER MODE button is pressed.

- After confirming or changing the settings, press the START/STOP button to start operation.

TO CHANGE THE TIMER MODE DURING OPERATION

- Press the TIMER MODE button and set the unit to the desired mode.

TO CHANGE THE TIMER SETTING DURING OPERATION

- Refer to step 2.

TO CANCEL THE TIMER MODE DURING TIMER OPERATION

- Press the TIMER MODE button and set the display to "NON STOP". The unit will switch to NON STOP OPERATION.

TO STOP OPERATION DURING USE OF TIMER MODE

- Press the START/STOP button.

OPERATION

DEFROST MODE

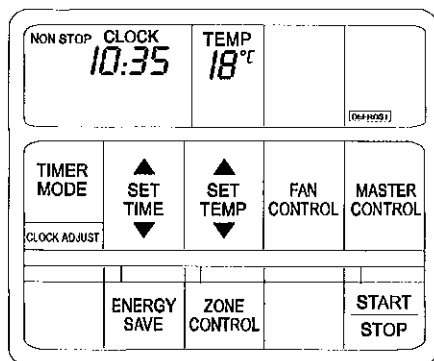

When the outside temperature is low and the humidity is high, frost may collect on the outside unit, reducing heating efficiency. When this occurs, the system will automatically start the defrost cycle. During the defrost cycle, the indoor fan will shut down and DEFROST will be displayed on the remote controller. It will take approximately 4 to 15 minutes before the air conditioner will start up again.

USING ENERGY SAVE

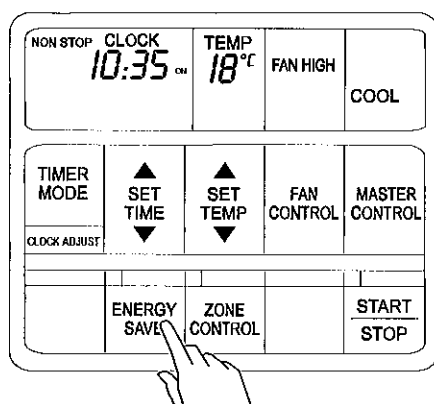

TO USE THE ENERGY SAVE FUNCTION

Press the ENERGY SAVE button. The unit will run in the energy save mode. The light above the ENERGY SAVE button will switch on.

TO STOP ENERGY SAVE FUNCTION

Press the ENERGY SAVE button. The energy save mode will be turned off. The ENERGY SAVE light will go off and the unit will return to the former operating conditions.

- The energy conservation mode (ENERGY SAVE) raises the set temperature slightly in the cooling mode and lowers the set temperature in the heating mode, using a computer program to economically control the operation of the unit as follows:

Heating mode

After the ENERGY SAVE button is pressed, the set temperature will be lowered approximately 1°C every 30 minutes. When it has lowered approximately a total of 2°C, it will then hold that temperature.

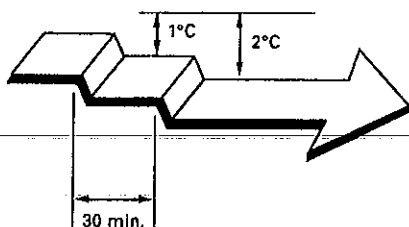

- If you press the ENERGY SAVE button while the unit is in operation, it will change to the conservation mode. If you press the ENERGY SAVE button while the unit is in timer mode (ON timer, PROGRAM timer, or REPEAT timer), the unit will go into the conservation mode when the unit starts with the timer.

Cooling mode

After the ENERGY SAVE button is pressed, the set temperature will be raised approximately 0.5°C every 30 minutes. When it has lowered approximately a total of 1°C, it will then hold that temperature.

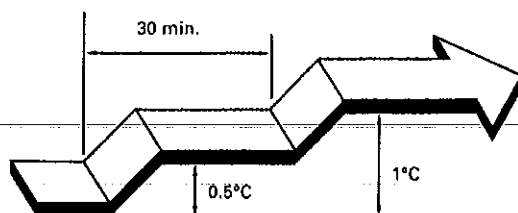

- If you turn off the air conditioner while in the conservation mode, the mode will be shut off.
- The temperature set on the remote control will not change if the energy save mode is used.

CARE AND MAINTENANCE



CAUTION

Before cleaning or maintaining the system, stop the operation of the unit and disconnect the power supply

- Turn OFF the electrical breaker
- The fan operates at high speed inside the unit injury may result.

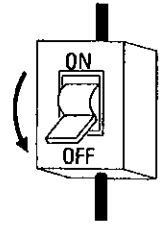

MAINTENANCE

Regular professional maintenance is recommended. Consult an authorised service agent.

The following is an indication of part of the maintenance recommended.

1. Filter cleaning – also see below

This is most important and should be completed regularly.

2. Outdoor unit

Check

- Coil for obstructions
- Fans operation and condition
- All electrical connections

- Brackets and or fixings
- Gas charge and gas connections

3. Indoor unit

Check:

- Main primary drain, drain tray, safety tray and drain (clean as required)
- Fans and motor
- All electrical cables and connections
- Unit positioning
- Hanging brackets and/or fixings
- Gas connections.

CLEANING THE AIR FILTER

- Ensure that the filter is always installed in the inlet air grille of the indoor unit.
- If dirt is allowed to collect in the air filter, the airflow will be reduced, leading to reduced performance and increased operating noise.
- Ensure that filters are cleaned regularly.

4. Use a vacuum cleaner or let water flow through (hose out) the air filter to remove the dirt and dust from the air filter. Alternatively wash the filter in synthetic detergent.

Clean the filter according to the following steps:

1. Turn OFF the main power switch.
2. Locate the filter. The filter is usually located in or near the opening of the return air grille.
3. Typically remove the air filter from the return air inlet grille usually by supporting the air grille. The return air grille is often hinged on one side. Do not to let the filter slide out and drop during opening of the grille.

NOTE: Some grilles have concealed magnetic catches, hinges, screws or special catches. (The filter is usually behind the grille).

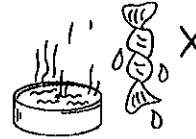

NOTE: Do not use water that is hotter than 45°C when cleaning system components.

5. Allow the air filter to dry after shaking off moisture.
6. Refit the filter and return air grille into position.
7. Turn ON the main power. Start the unit at the wall controller.

NOTE: Filters may be purchased through your local dealer. Do not run the system without the return air filter in its position and keep the filter clean.

OUTDOOR UNIT

- Check for obstructions (e.g. dirt, leaves, paper, plastic, rubbish etc) that may obstruct airflow. Check that the outdoor unit does not have plants etc. blocking airflow.

- Inspect and listen for excessive or unusual fan motor noises.
- Ensure air from discharge is not being drawn into the inlet due to obstructions.

CLEANING THE INDOOR UNIT

- When cleaning the air conditioner, turn OFF the electrical supply.
- Do not use inflammable sprays such as lacquer or hair spray near the air conditioner.
- Authorised persons should conduct maintenance. The coil and drainage system should be cleaned

- biannually, including trays and drainpipes.
- For heavy usage conditions maintenance should be conducted more often.
- Fans should be checked for the accumulation of dirt and cleaned as necessary.

WHEN NOT USING THE UNIT FOR EXTENDED PERIODS



CAUTION

When not using the unit for extended periods, turn off the electrical breaker for safety.

ERRORS AND SELF-DIAGNOSIS

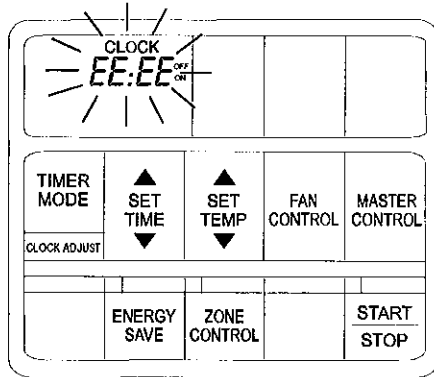

If there is a problem with the air conditioner, it will stop running. "EE:EE" will be displayed instead of the time.

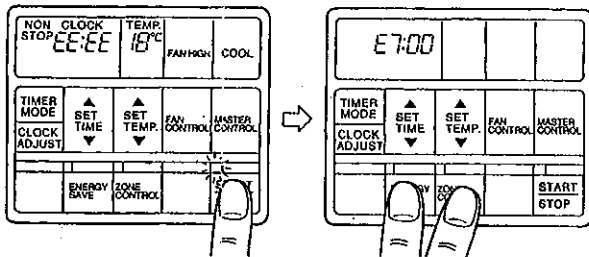

RUN SELF-DIAGNOSIS

- 1.If the operation lamp is ON then press the START/STOP button to turn it OFF.
- 2.Press the ENERGY SAVE and the ZONE CONTROL buttons at the same time for more the 3 seconds to start the self-diagnosis check. An error code will be displayed in the clock display (time) area.
- 3.Press the ENERGY SAVE and the ZONE CONTROL buttons again for more than 3 seconds to end the self-diagnosis check.

ERROR CODE	ERROR
<i>E0:00</i>	Communication error (indoor unit to remote controller)
<i>E1:00</i>	Communication error (indoor unit to outdoor unit)
<i>E2:00</i>	Room temperature sensor open
<i>E3:00</i>	Room temperature sensor shorted
<i>E4:00</i>	Indoor heat exchanger temperature sensor open
<i>E5:00</i>	Indoor heat exchanger temperature sensor shorted
<i>E6:00</i>	Outdoor heat exchanger temperature sensor open
<i>E7:00</i>	Outdoor heat exchanger temperature sensor shorted
<i>E8:00</i>	Outdoor temperature sensor open
<i>E8:00</i>	Outdoor temperature sensor shorted
<i>EC:00</i>	Discharge pipe temperature sensor open
<i>ED:00</i>	Discharge pipe temperature sensor shorted
<i>EE:00</i>	High pressure abnormal
<i>EF:00</i>	Discharge pipe temperature abnormal

TROUBLESHOOTING

WARNING	In the event of a malfunction (burning smell etc) immediately stop operation of the system. Turn OFF the electrical breaker and consult authorised service personnel. Always be sure to turn OFF the electrical breaker to ensure that power is completely OFF.
----------------	---

Before requesting service, perform the following checks:

	SYMPTOM	EXPLANATION	SEE PAGE
NORMAL FUNCTIONS	Does not operate immediately	<ul style="list-style-type: none"> ■ If the unit is stopped and then immediately started again, the compressor will not operate for approximately 3 minutes, in order to prevent fuse blowouts. ■ Whenever the power switch is turned OFF and then ON again, the protection circuit will operate for approximately 3 minutes, preventing the unit operation during that period. 	—
	Makes noise	<ul style="list-style-type: none"> ■ During operation and immediately after stopping the unit, you may hear the sound of water flowing in the air conditioner's piping. Also, noise may be particularly noticeable for approximately 2 to 3 minutes after starting operation. (This is the sound of coolant flowing). 	—
	Indoor fan stops and starts	<ul style="list-style-type: none"> ■ When operating the system on AUTO FAN mode the indoor fan will stop for a brief time when changing fan speed, or when stopping or starting the compressor. 	—
	Smells	<ul style="list-style-type: none"> ■ Some smell may be emitted from the indoor unit. This smells is the result of room odours (e.g. furniture, tobacco etc) which have been taken into the air conditioner. 	—
	Mist or steam is emitted	<ul style="list-style-type: none"> ■ During the cooling operation, a thin mist may be seen emitting from the indoor unit. This is a result of sudden cooling of room air by the air emitted from the air conditioner, resulting in condensation and misting. ■ During heating operating, the outdoor unit's fan may stop, and steam may be seen rising from the unit. This is due to operation of the defrosting mode. 	—
CHECK ONCE MORE	Does not operate at all	<ul style="list-style-type: none"> ■ Has there been a power failure? ■ Has a fuse blown out, or has a circuit breaker been tripped? ■ Is the main power switch set to the OFF position? ■ Is the timer operating? 	11
	Poor cooling performance	<ul style="list-style-type: none"> ■ Is the air filter dirty? ■ Are the air conditioner's intake or outlet vents blocked? ■ Is the temperature set correctly? ■ During cooling operation, is a window, door etc allowing bright sunlight or warm air to enter? (Close windows, doors, curtains etc). ■ During the cooling operation, is there a heat source operating inside the room, or are too many people in the room? 	13

TEMPERATURE AND HUMIDITY RANGE

Permissible ranges for temperature and humidity are as follows:

Cooling Operation	Outdoor temperature: Approximately 0°C to 52°C
	Indoor temperature: Approximately 18°C or more.
	Indoor humidity: Below approximately 80%. If the air conditioner is continually used for many hours, water may condense on the surface and drip.
Heating Operation	Outdoor temperature: Approximately -5°C to 21°C
	Indoor temperature: Approximately 30°C or below.

NOTE:

1. If the unit is used under higher temperatures than indicated above, the automatic protection circuit may operate, interrupting the operation.
2. If the unit is used under lower temperature conditions than indicated above, the heat exchanger may freeze causing water leakage or other malfunctions.
3. Do not use the air conditioner for any purposes other than room cooling, room heating or fan.
4. This air conditioner uses a heat pump, which absorbs heat from outside air and brings it indoors. As a result, its heating performance is reduced as the temperature outside drops. If you find that insufficient room heat is produced, we recommend that you use the air conditioner together with other heating appliances.
5. Heat pump type air conditioners use warm air recirculation to warm your entire room. As a result, after starting the system, some time will be required before the entire room becomes warm.

SPECIFICATIONS

Indoor Fan Coil Outdoor Unit		Model Model	CDS25R AOT25R	CDS36R AOT36R	CDS45R AOT45R	CDS54R AOT54R	
CAPACITY @ Rated Airflow	COOLING	kW	7.8	11.2	15.0	17.5	
	HEATING	kW	7.9	11.2	14.9	17.4	
	Rated Airflow	l / sec	480	760	860	980	
Electrical	Mains	Volts-Ph.-Hz.	240 / 1 / 50	415 / 3 / 50	415 / 3 / 50	415 / 3 / 50	
	Unit Input	Cooling Rated	kW	3.14	4.63	5.78	6.64
		Heating Rated	kW	2.64	3.65	5.07	5.86
	Running Current	Cooling Rated	Amps	15.55	10.6 / Ph	12.6 / Ph	14.1 / Ph
		Heating Rated	Amps	13.05	8.4	11.4	12.8
Indoor Unit	Weight	Gross / Nett	kg	39 / 37	49 / 44	50 / 45	59 / 52
	Dimensions	Height	mm	387	420	420	420
		Width	mm	850	975	975	1160
		Depth	mm	500	540	540	555
Outdoor Unit	Refrigeration System	Refrigerant (R22)	kg.	2.07	2.8	3.4	4.3
	Weight	Gross / Nett	kg	76 / 68	110 / 96	122 / 108	134 / 120
	Dimensions	Height	mm	643	1152	1152	1152
		Width	mm	840	940	940	940
		Depth	mm	336	370	370	370
Sound Level	Sound power	dB(A)	72	72	74	76	

NOTES

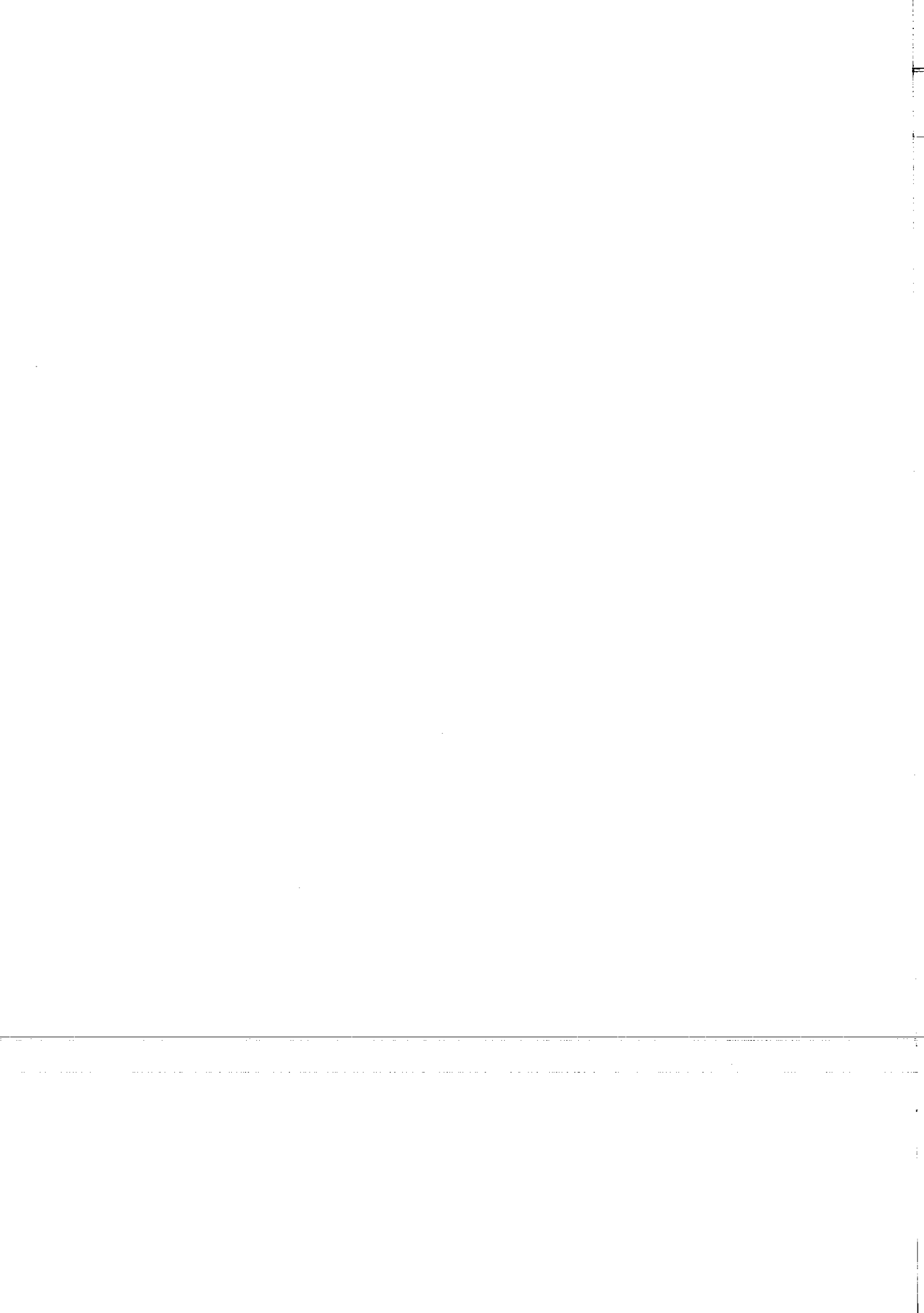

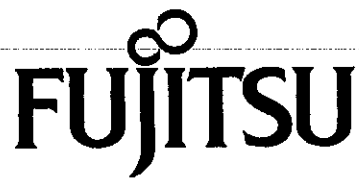

FUJITSU GENERAL (AUST.) PTY LIMITED
A.C.N. 001 229 554