

AIR CONDITIONER WALL MOUNTED TYPE

Indoor Unit

AST7 SERIES

AST9 SERIES

AST12 SERIES

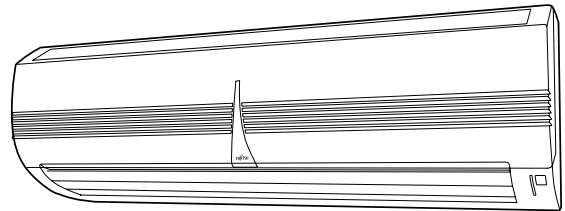

**KEEP THIS MANUAL
FOR FUTURE REFERENCE**

<p>⚠ CAUTION</p> <p>R410A REFRIGERANT</p> <p><small>This Air Conditioner contains and operates with refrigerant R410A and Polyol Ester oil.</small></p> <p>THIS PRODUCT MUST ONLY BE INSTALLED OR SERVICED BY QUALIFIED PERSONNEL.</p> <p><small>Refer to Commonwealth, State, Territory and local legislation, regulations, codes, installation & operation manuals, before the installation, maintenance and/or service of this product.</small></p>



CONTENTS

SAFETY PRECAUTIONS	1	ADJUSTING THE DIRECTION OF	
FEATURES AND FUNCTIONS	2	AIR CIRCULATION	11
NAME OF PARTS	3	SWING OPERATION	12
PREPARATION	5	MANUAL AUTO OPERATION	12
OPERATION	6	CLEANING AND CARE	13
TIMER OPERATION	9	TROUBLESHOOTING	16
SLEEP TIMER OPERATION	10	OPERATING TIPS	17

SAFETY PRECAUTIONS

Instructions relating to heating (*) are applicable only to "HEAT & COOL MODEL" (Reverse Cycle).

- Before using the appliance, read these "PRECAUTIONS" thoroughly and operate in the correct way.
- The instructions in this section all relate to safety; be sure to maintain safe operating conditions.
- "DANGER", "WARNING" and "CAUTION" have the following meanings in these instructions:

 DANGER!	This mark indicates procedures which, if improperly performed, are most likely to result in the death of or serious injury to the user or service personnel.
 WARNING!	This mark indicates procedures which, if improperly performed, might lead to the death or serious injury of the user.
 CAUTION!	This mark indicates procedures which, if improperly performed, might possibly result in personal harm to the user, or damage to property.

DANGER!

- Do not attempt to install this air conditioner by yourself.
- This unit contains no user-serviceable parts. Always consult authorized service personnel for repairs.
- When moving, consult authorized service personnel for disconnection and installation of the unit.
- Do not become excessively chilled by staying for lengthy periods in the direct cooling airflow.
- Do not insert fingers or objects into the outlet port or intake grilles.
- Do not start and stop air conditioner operation by disconnecting the power supply cord and so on.
- Take care not to damage the power supply cord.
- In the event of a malfunction (burning smell, etc.), immediately stop operation, turn off the circuit breaker, and consult authorized service personnel.
- If the power supply cord of this appliance is damaged, it should only be replaced by the authorized service personnel, since special purpose tools and specified cord are required.

CAUTION!

- Provide occasional ventilation during use.
- Do not direct air flow at fireplaces or heating apparatus.
- Do not climb on, or place objects on, the air conditioner.
- Do not hang objects from the indoor unit.
- Do not set flower vases or water containers on top of air conditioners.
- Do not expose the air conditioner directly to water.
- Do not operate the air conditioner with wet hands.
- Do not pull power supply cord.
- Turn off power source when not using the unit for extended periods.
- Check the condition of the installation stand for damage.
- Do not place animals or plants in the direct path of the air flow.
- Do not drink the water drained from the air conditioner.
- Do not use in applications involving the storage of foods, plants or animals, precision equipment, or art works.
- *● Connection valves become hot during Heating; handle with care.
 - Do not apply any heavy pressure to radiator fins.
 - Operate only with air filters installed.
 - Do not block or cover the intake grille and outlet port.
 - Ensure that any electronic equipment is at least one metre away from either the indoor or outdoor units.
 - Avoid installing the air conditioner near a fireplace or other heating apparatus.
 - When installing the indoor and outdoor units, take precautions to prevent access by infants.
 - Do not use inflammable gases near the air conditioner.

FEATURES AND FUNCTIONS

Instructions relating to heating (*) are applicable only to "HEAT & COOL MODEL" (Reverse Cycle).

AUTOMATIC OPERATION

*● HEAT & COOL MODEL (REVERSE CYCLE)

Merely press the START/STOP button, and the unit will begin automatic operation in either the Heating, Cooling, Dry or Monitor modes as appropriate, in accordance with the thermostat setting and the actual temperature of the room.

● COOLING MODEL

Merely press the START/STOP button, and the unit will begin automatic operation in the Cooling or Dry mode as appropriate, in accordance with the thermostat setting and the actual temperature of the room.

SLEEP TIMER

*● HEAT & COOL MODEL (REVERSE CYCLE)

When the SLEEP timer button is pressed during Heating mode, the air conditioner's thermostat setting is gradually lowered during the period of operation; during Cooling mode, the thermostat setting is gradually raised during the period of operation. When the set time is reached, the unit automatically turns off.

● COOLING MODEL

When the SLEEP timer button is pressed during Cooling mode, the thermostat setting is gradually raised during the period of operation. When the set time is reached, the unit automatically turns off.

WIRELESS REMOTE CONTROL UNIT

The WIRELESS REMOTE CONTROL UNIT allows convenient control of air conditioner operation.

SWING OPERATION

The Air Flow Direction Louvers swings automatically up and down so that the air speeds to every nook and corner of your room.

REMOVABLE INTAKE GRILLE

The indoor unit's INTAKE GRILLE can be removed for easy cleaning and maintenance.

MILDEW-RESISTANT FILTER

The AIR FILTER has been treated to resist mildew growth, thus allowing cleaner use and easier care.

SUPER QUIET OPERATION

When the FAN CONTROL button is used to select QUIET, the unit begins super-quiet operation; the indoor unit's air-flow is reduced for quieter operation.

AIR CLEANING FILTER

The Air Cleaning Filter and Deodorant filter use an electrostatic principle to clean the air of fine particulate matter such as tobacco smoke and plant pollen.

NAME OF PARTS

Instructions relating to heating (*) are applicable only to "HEAT & COOL MODEL" (Reverse Cycle).

Fig. 1

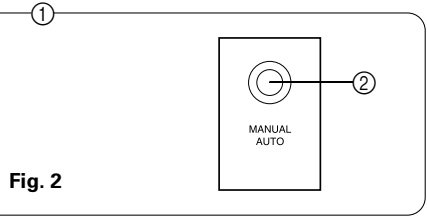
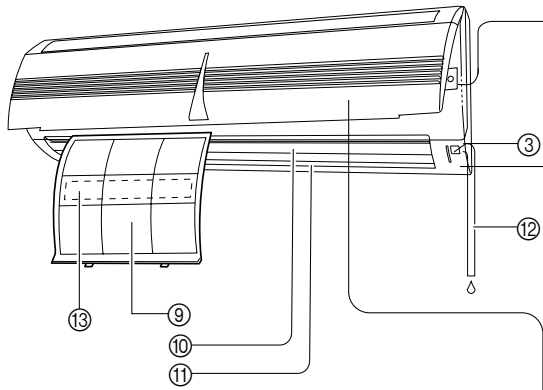

Fig. 2

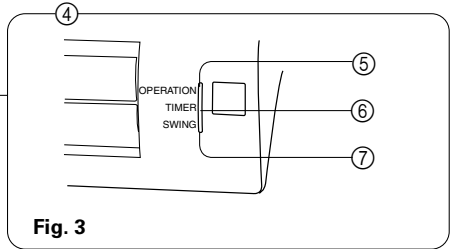

Fig. 3

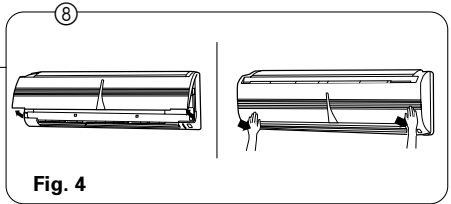

Fig. 4

Fig. 5

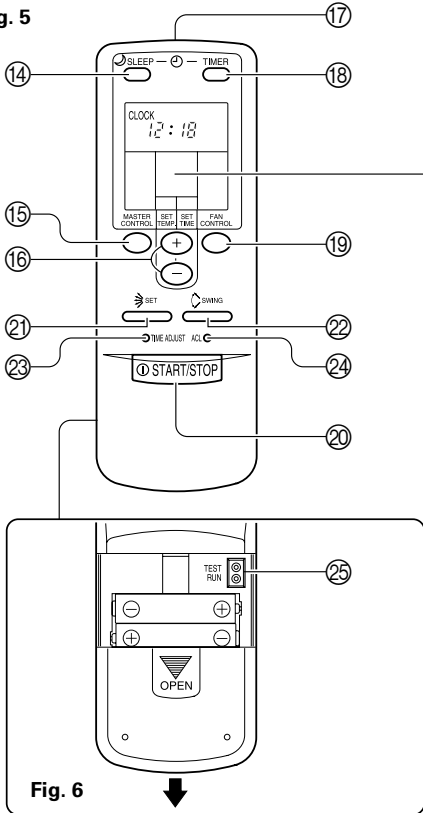
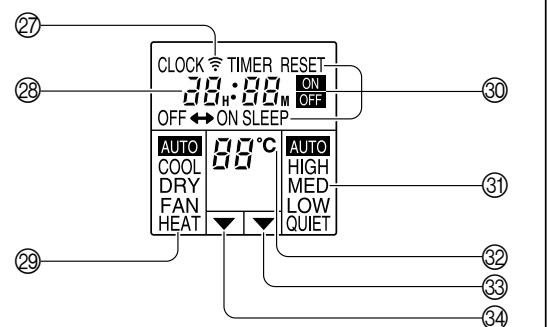

Fig. 6

* HEAT & COOL MODEL (REVERSE CYCLE)



COOLING MODEL

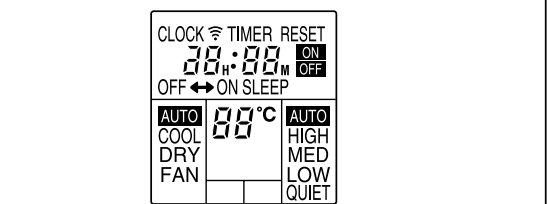

Fig. 7

To facilitate explanation, the accompanying illustration has been drawn to show all possible indicators; in actual operation, however, the display will only show those indicators appropriate to the current operation.

Fig. 1 Indoor Unit

- ① **Operating Control Panel (Fig. 2)**
- ② **MANUAL AUTO button**
- ③ **Remote Control Signal Receiver**
- ④ **Indicator Lamps (Fig. 3)**
 - ⑤ **OPERATION Indicator Lamp (red)**
 - Lights when unit is operating.
 - * ● The lamp will flash slowly when the defrosting operation (see page 17).
 - * ● The lamp will flash quickly (1 second on, 1 second off) when the selected operating mode can not be used (see page 18).
 - ⑥ **TIMER Indicator Lamp (green)**
 - If the TIMER indicator lamp flashes when the timer is operating, it indicates that a fault has occurred with the timer setting (see page 17 Auto Restart).
 - ⑦ **SWING Indicator Lamp (orange)**
- ⑧ **Intake Grille (Fig. 4)**
- ⑨ **Air Filter**
- ⑩ **Air Flow Direction Louver**
- ⑪ **Right-Left Louver (behind Air Flow Direction Louver)**
- ⑫ **Drain Hose**
- ⑬ **Air Cleaning Filter**

Fig. 5 Remote Control Unit

- ⑭ **SLEEP button**
- ⑮ **MASTER CONTROL button**
- ⑯ **SET TEMP./SET TIME buttons (⊕/⊖)**
- ⑰ **Signal Transmitter**
- ⑱ **TIMER button**
- ⑲ **FAN CONTROL button**
- ⑳ **START/STOP button**
- ㉑ **AIR FLOW DIRECTION button**
- ㉒ **SWING LOUVER button**
- ㉓ **TIME ADJUST button**
- ㉔ **ACL button**

Rear side (Fig. 6)

- ㉕ **TEST RUN**
 - Touch the two metal contacts with a metallic object to send the signal to perform a test run.
 - Perform a test run only when installing the air conditioner. If the signal to perform a test run is received during normal operation, the air conditioner's thermostat will malfunction.
 - If the signal to perform a test run is received during normal operation, the unit will switch to the test operation mode and the indoor unit's OPERATION and TIMER indicator lamps will flash simultaneously.
 - To stop the test operation mode, press the START/STOP button to stop the air conditioner.

㉖ **Remote Control Unit Display (Fig. 7)**

- ㉗ **Transmit Indicator**
- ㉘ **Clock Display**
- ㉙ **Operating Mode Display**
- ㉚ **Timer Mode Display**
- ㉛ **Fan Speed Display**
- ㉜ **Temperature Set Display**
- ㉝ **Timer Set Indicator**
- ㉞ **Temperature Set Indicator**

PREPARATION

Turn on the Power

Turn on the circuit breaker.

Load Batteries (R03/LR03 × 2)

1 Press and slide the battery compartment lid on the reverse side to open it.

Slide in the direction of the arrow while pressing the ▼ mark.

2 Insert batteries.

Be sure to align the battery polarities (⊕/⊖) correctly.



3 Close the battery compartment lid.

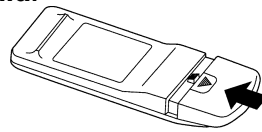

Set the Current time

1 Press the TIME ADJUST button (Fig. 6 ㉓).

Use the tip of a ball-point pen or other small object to press the button.

2 Use the ⊕/⊖ SET TIME buttons (Fig. 5 ㉒) to adjust the clock to the current time.

⊕ button: Press to advance the time.

⊖ button: Press to reverse the time.

(Each time the buttons are pressed, the time will be advanced/reversed in one-minute increments; hold the buttons depressed to change the time quickly in ten-minute increments.)

3 Press the TIME ADJUST button again.

This completes the time setting and starts the clock.

To Use the Remote Control Unit

- The remote control unit must be pointed at signal receiver (Fig. 1 ㉑) to operate correctly.
- Operating range: About 7 meters.
- When a signal is properly received by the air conditioner, a beeping sound will be heard.
- If no beep is heard, press the remote control unit button again.

Remote Control Unit Holder

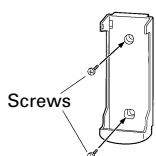

① Mount the Holder.

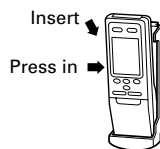

② Set the Remote Control Unit.

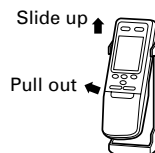

③ To remove the Remote Control Unit (when use at hand).

⚠ CAUTION!

- Take care to prevent infants from accidentally swallowing batteries.
- When not using the remote control unit for an extended period, remove the batteries to avoid possible leakage and damage to the unit.
- If leaking battery fluid comes in contact with your skin, eyes, or mouth, immediately wash with copious amounts of water, and consult your physician.
- Dead batteries should be removed quickly and disposed of properly, either by placing in a public battery collection receptacle, or by returning to appropriate authority.
- Do not attempt to recharge dry batteries.

Never mix new and used batteries, or batteries of different types. Batteries should last about one year under normal use. If the remote control unit's operating range becomes appreciably reduced, replace the batteries and press the ACL button with the tip of a ballpoint pen or other small object.

OPERATION

Instructions relating to heating (*) are applicable only to "HEAT & COOL MODEL" (Reverse Cycle).

To Select Mode Operation

- 1 Press the START/STOP button (Fig. 5 ⑳).**
The indoor unit's OPERATION indicator lamp (red) (Fig. 3 ㉔) will light.
The air conditioner will start operating.
- 2 Press the MASTER CONTROL button (Fig. 5 ⑮) to select the desired mode.**

Each time the button is pressed, the mode will change in the following order:



About three seconds later, the entire display will reappear.

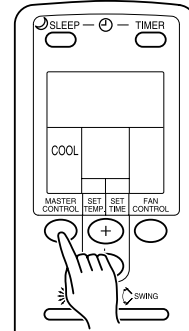

Example: When set to COOL

To Set the Thermostat

Press the SET TEMP. buttons (Fig. 5 ⑯).

- + button:** Press to raise the thermostat setting.
- button:** Press to lower the thermostat setting.

*●Thermostat setting range: HEAT & COOL MODEL (REVERSE CYCLE)

AUTO	18 to 30 °C
Heating	16 to 30 °C
Cooling/Dry	18 to 30 °C

The thermostat cannot be used to set room temperature during the FAN mode (the temperature will not appear on the remote control unit's display).

●Thermostat setting range: COOLING MODEL

AUTO	Standard temperature setting ± 2 °C
Cooling/Dry	18 to 30 °C
FAN	17 to 30 °C

(During use of FAN mode, if the thermostat is set at 17 °C or lower, the display will show "--" and the fan will operate continuously, regardless of the room temperature.)

About three seconds later, the entire display will reappear.

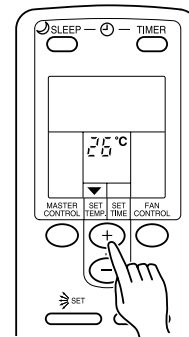

Example: When set to 26 °C

The thermostat setting should be considered a standard value, and may differ somewhat from the actual room temperature.

To Set the Fan Speed

Press the FAN CONTROL button (Fig. 5 ⑲).

Each time the button is pressed, the fan speed changes in the following order:



About three seconds later, the entire display will reappear.

OPERATION

Instructions relating to heating (*) are applicable only to "HEAT & COOL MODEL" (Reverse Cycle).

When set to AUTO:

- * **Heating** : Fan operates so as to optimally circulate warmed air. However, the fan will operate at very low speed when the temperature of the air issued from the indoor unit is low.
- Cooling** : As the room temperature approaches that of the thermostat setting, the fan speed becomes slower.
- * **Fan: HEAT & COOL MODEL (REVERSE CYCLE)**
The fan alternately turns on and off; when on, the fan runs at the low fan speed.
The fan will operate at very low setting during Monitor operation and at the start of the Heating mode.

Fan: COOLING MODEL

The fan will operate at the optimum speed in accordance with the room temperature in the vicinity of the indoor unit.

When set to QUIET:

SUPER QUIET operation begins. The indoor unit's airflow will be reduced for quieter operation.

- SUPER QUIET operation cannot be used during Dry mode. (The same is true when dry mode is selected during AUTO mode operation.)
- During Super Quiet operation, *(Heating and) Cooling performance will be reduced somewhat.

To Stop Operation

Press the START/STOP button.

The OPERATION indicator lamp (red) (Fig. 3 ⑤) will go out.

About Mode Operation

*AUTO (AUTO CHANGEOVER): HEAT & COOL MODEL (REVERSE CYCLE)

- When AUTO CHANGEOVER operation is selected, the air conditioner selects the appropriate operation mode (Cooling or Heating) in response to your room's temperature.
- When AUTO CHANGEOVER operation first selected, the fan will operate at very low speed for about one minute, during which time the unit detects the room conditions and selects the proper operating mode.
- When the air conditioner has adjusted your room's temperature to near the thermostat setting, it will begin monitor operation. In the monitor operation mode, the fan will operate at low speed. If the room temperature subsequently changes, the air conditioner will once again select the appropriate operation (Heating, Cooling) to adjust the temperature to the value set in the thermostat. (The monitor operation range is ± 2 °C relative to the thermostat setting.)
- If the mode automatically selected by the unit is not what you wish, see page 6 and select one of the mode operation (HEAT, COOL, DRY, FAN).

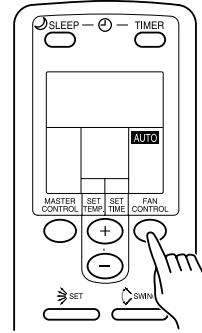

Example: When set to AUTO

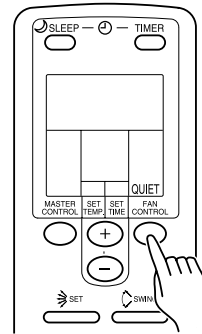

Example: When set to QUIET

AUTO: COOLING MODEL

- Depending on the room temperature at the time operation begins, the operating mode will be switched automatically as shown in the accompanying table. Also, depending on the operating mode, the room temperature setting will cause the "standard" temperature to be set as shown.

Actual Room Temperature	Operating Mode	Thermostat Setting (standard setting)
30 °C or above →	Cooling →	27 °C
27 to 30 °C →	Cooling →	26 °C
25 to 27 °C →	Dry →	24 °C
23 to 25 °C →	Dry →	22 °C
Below 23 °C →	Dry →	20 °C

The operating mode and standard thermostat settings are selected automatically when operation begins.

- When automatic operation is initiated, the fan will run at very low speed for about one minute while the unit detects and selects the proper operating mode.
- Once the operating mode has been set, the mode will not change even if the room temperature changes.
- If the START/STOP button is pressed to recommence operation within two hours after stopping automatic operation, the unit will begin operating from the same mode as before.

*Heating:

- Use to warm your room.
- When Heating mode is selected, the air conditioner will operate at very low fan speed for about 3 to 5 minutes, after which it will switch to the selected fan setting. This period of time is provided to allow the indoor unit to warm up before beginning full operation.
- When the room temperature is very low, frost may form on the outside unit, and its performance may be reduced. In order to remove such frost, the unit will automatically enter the defrost cycle from time to time. During Automatic Defrosting operation, the OPERATION indicator lamp (red) will flash, and the heat operation will be interrupted.

Cooling:

- Use to cool your room.

Dry:

- Use for gently cooling while dehumidifying your room.
- You cannot heat the room during Dry mode.
- During Dry mode, the unit will operate at low speed; in order to adjust room humidity, the indoor unit's fan may stop from time to time. Also, the fan may operate at very low speed when detecting room humidity.
- The fan speed cannot be changed manually when Dry mode has been selected.

Fan:

- Use to circulate the air throughout your room.

* During Heating mode:

Set the thermostat to a temperature setting that is higher than the current room temperature. The Heating mode will not operate if the thermostat is set lower than the actual room temperature.

During Cooling/Dry mode:

Set the thermostat to a temperature setting that is lower than the current room temperature. The Cooling and Dry modes will not operate if the thermostat is set higher than the actual room temperature (in Cooling mode, the fan alone will operate).

* During Fan mode:

HEAT & COOL MODEL (REVERSE CYCLE)

You can not use the unit to heat and cool your room.

During Fan mode: COOLING MODEL

- Fan operation begins when room temperature in the vicinity of the air conditioner rises above the set thermostat temperature; when the temperature drops, fan operation stops.
- If the air emitted feels too cool, raise the thermostat setting.

TIMER OPERATION

Before using the timer function, be sure that the Remote Control Unit is set to the correct current time (see page 5).

To Use the ON timer or OFF timer

- 1 Press the **START/STOP** button (Fig. 5 ㉑)
(if the unit is already operating, proceed to step 2).
The indoor unit's OPERATION indicator lamp (red) (Fig. 3 ㉓) will light.

- 2 Press the **TIMER** button (Fig. 5 ㉒) to select the **OFF timer** or **ON timer** operation.

Each time the button is pressed the timer function changes in the following order:

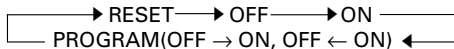

The indoor unit's **TIMER** indicator lamp (green) (Fig. 3 ㉓) will light.

- 3 Use the **SET TIME** buttons (Fig. 5 ㉔) to adjust the desired **OFF time** or **ON time**.

Set the time while the time display is flashing (the flashing will continue for about five seconds).

- ➕ **button**: Press to advance the time.
- ➖ **button**: Press to reverse the time.

About five seconds later, the entire display will reappear.

To Cancel the Timer

Use the **TIMER** button to select "TIMER RESET".
The air conditioner will return to normal operation.

To Change the Timer Settings

Perform steps 2 and 3.

To Stop Air Conditioner Operation while the Timer is Operating

Press the **START/STOP** button.

To Change Operating Conditions

If you wish to change the operating conditions (Mode, Fan Speed, Thermostat Setting), after making the timer setting, wait until the entire display reappears, then press the appropriate buttons to change the operating condition desired.

To Use the PROGRAM timer

- 1 Press the **START/STOP** button (Fig. 5 ㉑)
(if the unit is already operating, proceed to step 2).
The indoor unit's OPERATION indicator lamp (red) (Fig. 3 ㉓) will light.

- 2 Set the desired times for **OFF timer** and **ON timer**.
See the section "To Use the ON timer or OFF timer" to set the desired mode and times.
About three seconds later, the entire display will reappear.
The indoor unit's **TIMER** indicator lamp (green) (Fig. 3 ㉓) will light.

- 3 Press the **TIMER** button (Fig. 5 ㉒) to select the **PROGRAM** timer operation (either **OFF → ON** or **OFF ← ON** will display).

The display will alternately show "OFF timer" and "ON timer", then change to show the time setting for the operation to occur first.

- The **PROGRAM** timer will begin operation. (If the **ON** timer has been selected to operate first, the unit will stop operating at this point.)

About five seconds later, the entire display will reappear.

To Cancel the Timer

Use the **TIMER** button to select "TIMER RESET".
The air conditioner will return to normal operation.

To Change the Timer Settings

1. Follow the instructions given in the section "To Use the ON Timer or OFF Timer" to select the timer setting you wish to change.
2. Press the **TIMER** button to select either **OFF → ON** or **OFF ← ON**.

To Stop Air Conditioner Operation while the Timer is Operating

Press the **START/STOP** button.

To Change Operating Conditions

If you wish to change operating conditions (Mode, Fan Speed, Thermostat Setting), after making the timer setting wait until the entire display reappears, then press the appropriate buttons to change the operating condition desired.

About the PROGRAM timer

- The **PROGRAM** timer allows you to integrate **OFF** timer and **ON** timer operations in a single sequence. The sequence can involve one transition from **OFF** timer to **ON** timer, or from **ON** timer to **OFF** timer, within a twenty-four hour period.
- The first timer function to operate will be the one set nearest to the current time. The order of operation is indicated by the arrow in the Remote Control Unit's display (**OFF → ON**, or **OFF ← ON**).
- One example of **PROGRAM** timer use might be to have the air conditioner automatically stop (**OFF** timer) after you go to sleep, then start (**ON** timer) automatically in the morning before you arise.

SLEEP TIMER OPERATION

Instructions relating to heating (*) are applicable only to "HEAT & COOL MODEL" (Reverse Cycle).

Unlike other timer functions, the SLEEP timer is used to set the length of time until air conditioner operate is stopped.

To Use the SLEEP timer

While the air conditioner is operating or stopped, press the SLEEP button (Fig. 5 ⑭).

Both the indoor unit's OPERATION indicator lamp (red) (Fig. 3 ⑤) and the TIMER indicator lamp (green) (Fig. 3 ⑥) will light.

To Change the Timer Settings

Press the SLEEP button (Fig. 5 ⑭) once again and set the time using the SET TIME buttons (Fig. 5 ⑯).

Set the time while the Timer Mode Display is flashing (the flashing will continue for about five seconds).

- **button:** Press to advance the time.
- **button:** Press to reverse the time.

About five seconds later, the entire display will reappear.

About the SLEEP timer

To prevent excessive warming or cooling during sleep, the SLEEP timer function automatically modifies the thermostat setting in accordance with the time setting. When the set time has elapsed, the air conditioner completely stops.

*During Heating operation:

When the SLEEP timer is set, the thermostat setting is automatically lowered 1 °C every thirty minutes. When the thermostat has been lowered a total of 4 °C, the thermostat setting at that time is maintained until the set time has elapsed, at which time the air conditioner automatically turns off.

During Cooling/Dry operation:

When the SLEEP timer is set, the thermostat setting is automatically raised 1 °C every sixty minutes. When the thermostat has been raised a total of 2 °C, the thermostat setting at that time is maintained until the set time has elapsed, at which time the air conditioner automatically turns off.

SLEEP timer setting

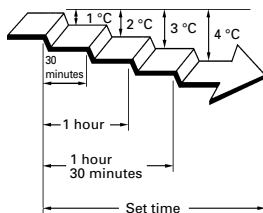

SLEEP timer setting

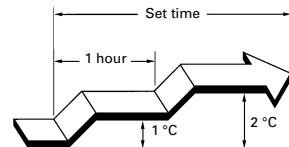

ADJUSTING THE DIRECTION OF AIR CIRCULATION

Instructions relating to heating (*) are applicable only to "HEAT & COOL MODEL" (Reverse Cycle).

Vertical (up-down) direction of airflow is adjusted by pressing the Remote Control Unit's AIR FLOW DIRECTION button. Horizontal (right-left) airflow direction is adjusted manually, by moving the Air Flow Direction Louvers.

Whenever making horizontal airflow adjustments, start air conditioner operation and be sure that the vertical air direction louvers are stopped.

Vertical Air Direction Adjustment

Press the AIR FLOW DIRECTION button (Fig. 5 ②).

Each time the button is pressed, the air direction range will change as follows:

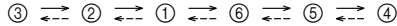

Types of Air flow Direction Setting:

①, ②, ③ : During Cooling/Dry modes

④, ⑤, ⑥ : During Heating mode

The remote Control Unit's display does not change.

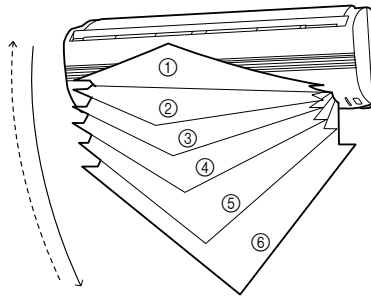

- Use the air direction adjustments within the ranges shown above.
- The vertical airflow direction is set automatically as shown, in accordance with the type of operation selected.
 - During Cooling/Dry modes : Horizontal flow ①
 - * During Heating mode : Downward flow ⑤
- During AUTO mode operation, for the first minute after beginning operation, airflow will be horizontal ①; the air direction cannot be adjusted during this period.

⚠ DANGER!

Never place fingers or foreign objects inside the outlet ports, since the internal fan operates at high speed and could cause personal injury.

- Always use the remote control unit's AIR FLOW DIRECTION button to adjust the vertical airflow louvers. Attempting to move them manually could result in improper operation; in this case, stop operation and restart. The louvers should begin to operate properly again.
- During use of the Cooling and Dry modes, do not set the Air Flow Direction Louvers in the Heating range (④ - ⑥) for long periods of time, since water vapor may condense near the outlet louvers and drops of water may drip from the air conditioner. During the Cooling and Dry modes, if the Air Flow Direction Louvers are left in the heating range for more than 30 minutes, they will automatically return to position ③.
- When used in a room with infants, children, elderly or sick persons, the air direction and room temperature should be considered carefully when making settings.

Right-Left Adjustment

Adjust the Right-Left louvers.

- Move the Right-Left louvers to adjust air flow in the direction you prefer.

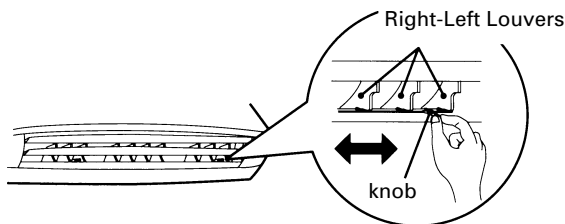

SWING OPERATION

Begin air conditioner operation before performing this procedure.

To select SWING Operation

Press the SWING LOUVER button (Fig. 5 ②).

The SWING indicator lamp (orange) (Fig. 3 ⑦) will light.

In this mode, the Air Flow Direction Louvers will swing automatically to direct the airflow both up and down.

To Stop SWING Operation

Press the SWING LOUVER button (Fig. 5 ②) once again.

The SWING indicator lamp (orange) (Fig. 3 ⑦) will go out.

Airflow direction will return to the setting before swing was begun.

About Swing Operation

- The range of swing is relative to the currently set airflow direction.
- If the swing range is not as desired, use the Remote Control Unit's AIR FLOW DIRECTION button to change the range of swing.
- During Cooling/Dry modes, if SWING Operation is continued at the lowest (downward) range for more than 30 minutes, the unit will automatically switch the swing range to the horizontal flow range to prevent the condensation of moisture on the outlet.
- The SWING operation may stop temporarily when the air conditioner's fan is not operating, or when operating at very low speeds.

MANUAL AUTO OPERATION

Use the MANUAL AUTO operation in the event the Remote Control Unit is lost or otherwise unavailable.

How To Use the Main Unit Controls

Press the MANUAL AUTO button (Fig. 2 ②) on the main unit control panel.

To stop operation, press the MANUAL AUTO button once again. (Controls are located inside the intake grille.)

- When the air conditioner is operated with the controls on the Main unit, it will operate under the same mode as the AUTO mode selected on the Remote Control Unit (see page 7).
- The fan speed selected will be "AUTO" and the thermostat setting will be standard.

CLEANING AND CARE



CAUTION!

- Before cleaning the air conditioner, be sure to turn it off and disconnect the power supply cord.
- Be sure the intake grille (Fig. 1 ⑧) is installed securely.
- When removing and replacing the air filters, be sure not to touch the heat exchanger, as personal injury may result.

Cleaning the Intake Grille

1. Remove the intake grille.

- ① Place your fingers at both lower ends of the grille panel, and lift forward; if the grille seems to catch partway through its movement, continue lifting upward to remove.
- ② Pull past the intermediate catch and open the Intake Grille wide so that it become horizontal.

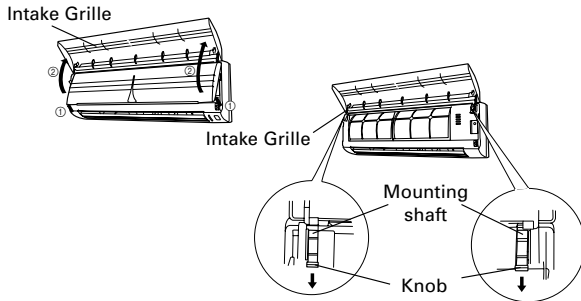

2. Clean with water.

Remove dust with a vacuum cleaner; wipe the unit with warm water, then dry with a clean, soft cloth.

3. Replace the intake grille.

- ① Pull the knobs all the way.
- ② Hold the grille horizontal and set the left and right mounting shafts into the bearings at the top of the panel.

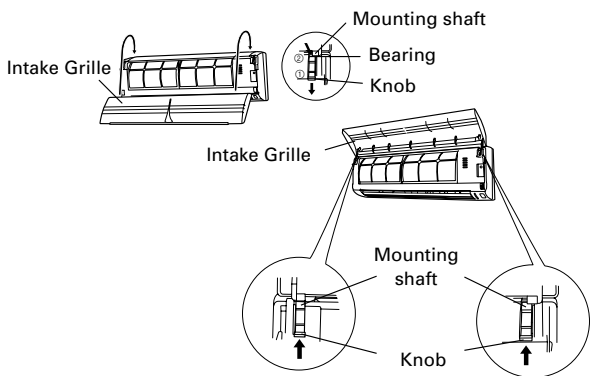

Cleaning the Air Filter

1. Open the intake grille, and remove the air filter.

Lift up the air filter's handle, disconnect the two lower tabs, and pull out.

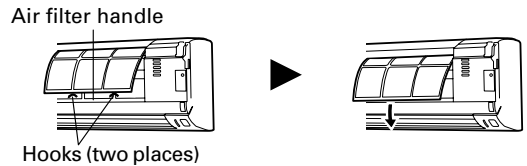

2. Remove dust with a vacuum cleaner or by washing.

After washing, allow to dry thoroughly in a shaded place.

3. Replace the air filter and close the intake grille.

- ① Align the sides of the air filter with the panel, and push in fully, making sure the two lower tabs are returned properly to their holes in the panel.



- ② Close the intake grille.

(For purposes of example, the illustration shows the unit without intake grille installed.)

- Dust can be cleaned from the air filter either with a vacuum cleaner, or by washing the filter in a solution of mild detergent and warm water. If you wash the filter, be sure to allow it to dry thoroughly in a shady place before re-installing.
- If dirt is allowed to accumulate on the air filter, air flow will be reduced, lowering operating efficiency and increasing noise.
- During periods of normal use, the air filters should be cleaned every two weeks.

Air Cleaning Filter Installation

1. Open the intake grille and remove the air filters.

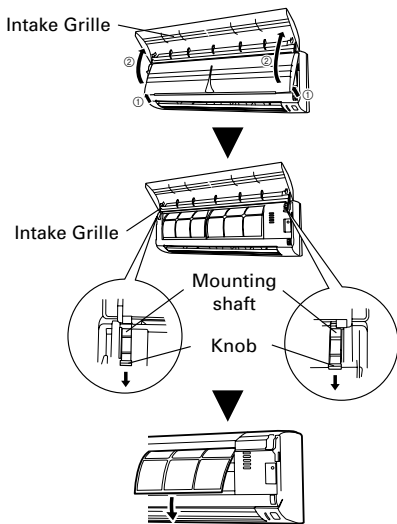

3. Install the two air filters and close the intake grille.

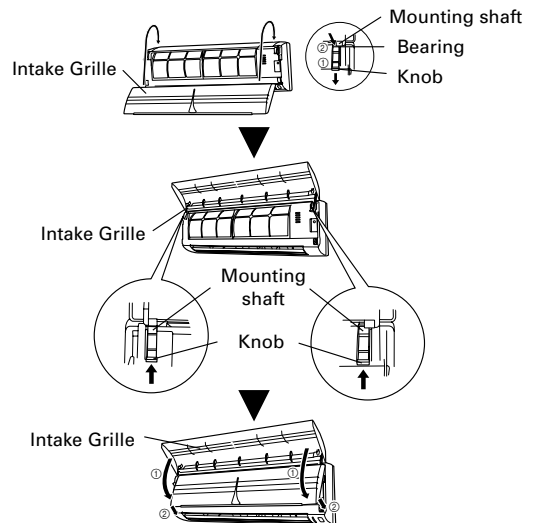

2. Install the air cleaning filter set (set of 2).

- ① Set the air cleaning filter into the air cleaning filter frame.

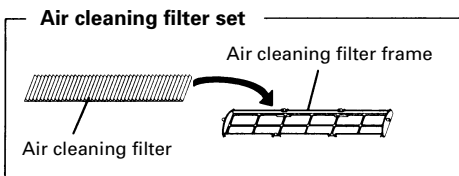

- ② Engage the latch at both ends of the filter with the two hooks at the rear of the air cleaning filter frame.

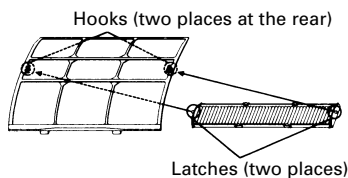

Take care that the air cleaning filter does not project beyond the frame.

- ③ Engage the four fixing locations at the top and bottom of the air cleaning filter frame with the hooks of the air filter.

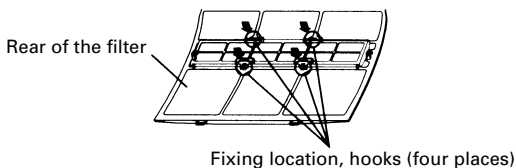

- When air cleaning filters are used, the effect will be increased by setting the fan speed to "High".

CLEANING AND CARE

Replacing dirty Air cleaning filters

Please purchase the separately sold replacement air cleaning filters and install them.

1. Open the intake grille and remove the air filters.

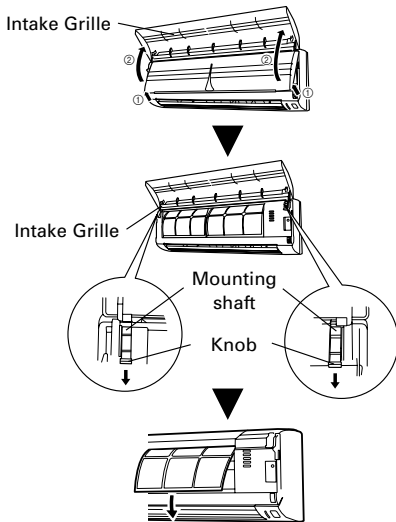

2. Replace them by two new air cleaning filters.

- ① Remove the old air cleaning filters in reverse order of their installation.
- ② Install in the same way as for installation of the air cleaning filter set.

3. Install the two air filters and close the intake grille.

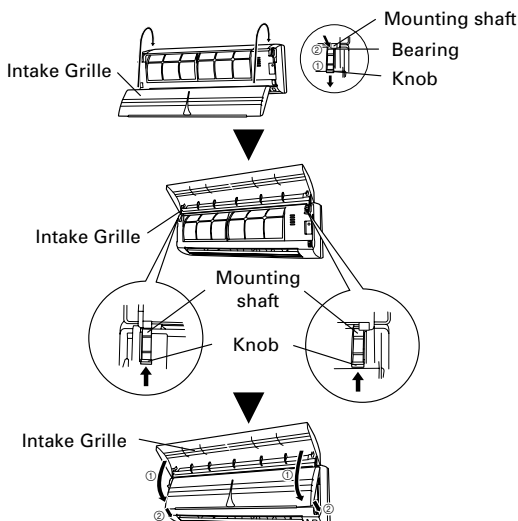

In regard to the Air cleaning filters
(The air cleaning filter type differs depending on the model.)

[AIR-PURIFYING FILTER (green filter)]

- Depending on the size of the room and the conditions in which the air conditioner is used, the normal life of the air-purifying filter is about three months. If the air-purifying filter becomes dirty within three months, replace it as soon as possible. (Always dispose of used air-purifying filters, do not reuse them.)

[DEODORIZING FILTER (black filter)]

- To regenerate the deodorizing effect, remove the dust with a vacuum cleaner and place the filter in direct sunlight for six hours about once every six months. Under normal conditions, the filter should be replaced after three years.
- For storage of the air cleaning filters, avoid places with high temperatures and high humidity, and use the filters as soon as possible after the package has been opened. (The air cleaning effect decreases when the filters are left in the opened package.)

[POLYPHENOL CATECHIN AIR CLEANING FILTER (white filter)]

- The Air Cleaning Filters are disposable filters. (They can not be washed and reused.)
- For storage of the Air Cleaning Filters, use the filters as soon as possible after the package has been opened. (The air cleaning effect decreases when the filters are left in the opened package)
- Generally, the filters should be exchanged about every three months.

Please buy delicate air cleaning filters (UTR-FC04-1) (Sold separately) to exchange the used dirty air cleaning filters.

[NEGATIVE AIR IONS DEODORIZING FILTER (light green filter)]

- The filters should be exchanged about every three years so as to maintain the deodorizing effect.
- Filter frame is not a one-off product.

Please buy delicate deodorizing filter (UTR-FC04-3) (Sold separately) when exchanging the filters.

Maintenance of Deodorizing Filters

In order to maintain the deodorizing effect, please clean the filter in the follow way once three months.

- ① Remove the deodorizing filter.
- ② Clean with water and dry in the air.
 - 1) Flush the filters with high-pressure hot water until the surface of the filters are covered with water. Please flush with diluent neutral detergent. (Never wash by reaming or rubbing, otherwise it will damage the deodorizing effect.)
 - 2) Rinse with water flow.
 - 3) Dry in shade.
- ③ Reinstall the deodorizing filter.

TROUBLESHOOTING

Instructions relating to heating (*) are applicable only to "HEAT & COOL MODEL" (Reverse Cycle).



In the event of a malfunction (burning smell, etc.), immediately stop operation, disconnect the Power Supply Plug or turn off the circuit breaker, and consult authorized service personnel. Merely turning off the unit's power switch will not completely disconnect the unit from the power source. Always be sure to turn off your circuit breaker to ensure that power is completely off.

Before requesting service, perform the following checks:

	Symptom	Problem	See page
NORMAL FUNCTION	Doesn't operate immediately:	<ul style="list-style-type: none"> ● If the unit is stopped and then immediately started again, the compressor will not operate for about 3 minutes, in order to prevent fuse blowouts. ● Whenever the power supply plug is disconnected and then reconnected to a power outlet, the protection circuit will operate for about 3 minutes, preventing unit operation during that period. 	—
	Noise is heard:	<ul style="list-style-type: none"> ● During operation and immediately after stopping the unit, the sound of water flowing in the air conditioner's piping may be heard. Also, noise may be particularly noticeable for about 2 to 3 minutes after starting operation (sound of coolant flowing). ● During operation, a slight squeaking sound may be heard. This is the result of minute expansion and contraction of the front cover due to temperature changes. 	—
		*● During Heating operation, a sizzling sound may be heard occasionally. This sound is produced by the Automatic Defrosting operation.	17
	Smells:	<ul style="list-style-type: none"> ● Some smell may be emitted from the indoor unit. This smell is the result of room smells (furniture, tobacco, etc.) which have been taken into the air conditioner. 	—
	Mist or steam are emitted:	<ul style="list-style-type: none"> ● During Cooling or Dry operation, a thin mist may be seen emitted from the indoor unit. This results from the sudden Cooling of room air by the air emitted from the air conditioner, resulting in condensation and misting. 	—
		*● During Heating operation, the outdoor unit's fan may stop, and steam may be seen rising from the unit. This is due to the Automatic Defrosting operation.	17
	Airflow is weak or stops:	*● When Heating operation is started, fan speed is temporarily very low, to allow internal parts to warm up.	—
		*● During Heating operation, if the room temperature rises above the thermostat setting, the outdoor unit will stop, and the indoor unit will operate at very low fan speed. If you wish to warm the room further, set the thermostat to a higher setting.	
		*● During Heating operation, the unit will temporarily stop operation (between 7 and 15 minutes) as the Automatic Defrosting mode operates. During the Automatic Defrosting operation, the OPERATION indicator lamp will flash.	17
		● The fan may operate at very low speed during Dry operation or when the unit is monitoring the room's temperature.	7
		● During SUPER QUIET operation, the fan will operate at very low speed.	7
		● In the monitor AUTO operation, the fan will operate at very low speed.	7
*● In case of Multi-type unit, if multiple units are operated in different operation modes as shown below, the units operated afterward will stop and the OPERATION indicator lamp (red) will flash. Heating mode and cooling mode (or dry mode) Heating mode and fan mode		18	
Water is produced from the outdoor unit:	*● During Heating operation, water may be produced from the outdoor unit due to the Automatic Defrosting operation.	17	

TROUBLESHOOTING

	Symptom	Items to check	See page
CHECK ONCE MORE	Doesn't operate at all:	<ul style="list-style-type: none"> ● Has the circuit breaker been turn off? ● Has there been a power failure? ● Has a fuse blown out, or a circuit breaker been tripped? 	—
		<ul style="list-style-type: none"> ● Is the timer operating? 	9
	Poor Cooling (or *Heating) performance:	<ul style="list-style-type: none"> ● Is the air filter dirty? ● Are the air conditioner's intake grille or outlet port blocked? ● Did you adjust the room temperature settings (thermostat) correctly? ● Is there a window or door open? ● In the case of Cooling operation, is a window allowing bright sunlight to enter? (Close the curtains.) ● In the case of Cooling operation, are there heating apparatus and computers inside the room, or are there too many people in the room? 	—
		<ul style="list-style-type: none"> ● Is the unit set for SUPER QUIET operation? 	7
The unit operates differently from the remote control unit's setting:	<ul style="list-style-type: none"> ● Are the Remote Control Unit's batteries dead? ● Are the Remote Control Unit's batteries loaded properly? 	5	

If the problem persists after performing these checks, or if you notice burning smells, or the TIMER indicator Lamp (Fig. 3 ③) flashes, immediately stop operation, turn off the circuit breaker, and consult authorized service personnel.

OPERATING TIPS

Instructions relating to heating (*) are applicable only to "HEAT & COOL MODEL" (Reverse Cycle).

Operation and Performance

*Heating Performance

- This air conditioner operates on the heat-pump principle, absorbing heat from outdoor air and transferring that heat indoors. As a result, the operating performance is reduced as outdoor air temperature drops. If you feel that insufficient heating performance is being produced, we recommend you use this air conditioner in conjunction with another kind of heating appliance.
- Heat-pump air conditioners heat your entire room by recirculating air throughout the room, with the result that some time may be required after first starting the air conditioner until the room is heated.

*When Indoor and Outdoor Temperatures are High

When both indoor and outdoor temperatures are high during use of the heating mode, the outdoor unit's fan may stop at times.

*Microcomputer-controlled Automatic Defrosting

- When using the Heating mode under conditions of low outdoor air temperature high humidity, frost may form on the outdoor unit, resulting in reduced operating performance.

In order to prevent this kind of reduced performance, this unit is equipped with a Microcomputer-controlled Automatic Defrosting function. If frost forms, the air conditioner will temporarily stop, and the defrosting circuit will operate briefly (for about 7 to 15 minutes).

During Automatic Defrosting operation, the OPERATION indicator lamp (red) will flash slowly.

AUTO Restart

In Event of Power Interruption

- The air conditioner power has been interrupted by a power failure. The air conditioner will then restart automatically in its previous mode when the power is restored.
- Operated by setting before the power failure.
- If a power failure occurs during TIMER operation, the timer will be reset and the unit will begin (or stop) operation at the new time setting. In the event that this kind of timer fault occurs the TIMER Indicator Lamp (green) will flash (see page 4).
- Use of other electrical appliances (electric shaver, etc.) or nearby use of a wireless radio transmitter may cause the air conditioner to malfunction. In this event, temporarily disconnect the Power Supply Plug, reconnect it, and then use the remote control unit to resume operation.

OPERATING TIPS

Multi-type Air conditioner

This indoor unit can be connected to a multi-type outdoor unit. The multi-type air conditioner allows multiple indoor units to be operated in multiple locations. The indoor units may be operated simultaneously, in accordance with their respective output.

Simultaneous Use of Multiple Units

Instructions relating to inverter (*) are applicable only to "INVERTER MODEL".

- When using a multi-type air conditioner, the multiple indoor units can be operated simultaneously, but when two or more indoor units of the same group are operated simultaneously, the heating and cooling efficiency will be less than when a single indoor unit is used alone. Accordingly, when you wish to use more than one indoor unit for cooling at the same time, the use should be concentrated at night and other times when less output is required. In the same way, when multiple units are used simultaneously for heating, it is recommended that they be used in conjunction with other auxiliary space heaters, as required.
- Seasonal and outdoor temperature conditions, the structure of the rooms and the number of persons present may also result in differences of operating efficiency. We recommend that you try various operating patterns in order to confirm the level of heating and cooling output provided by your units, and use the units in the way that best matches your family's lifestyle.
- If you discover that one or more units delivers a low level of cooling or heating during simultaneous operation, we recommend that you stop simultaneous operation of the multiple units.
- ✦ ● Operation cannot be done in the following different operating modes.
 - If the indoor unit is instructed to do an operating mode that it cannot perform, the OPERATION indicator lamp (red) on the indoor unit will flash (1 second on, 1 second off) and the unit will go into the standby mode.
 - Heating mode and cooling mode (or dry mode)
 - Heating mode and fan mode
 - Operation can be done in the following different operating modes.
 - Cooling mode and dry mode
 - Cooling mode and fan mode
 - Dry mode and fan mode
- ✦ ● The operating mode (heating mode or cooling (dry) mode) of the outdoor unit will be determined by the operating mode of the indoor unit that was operated first. If the indoor unit was started in fan mode, the operating mode of the outdoor unit will not be determined.

For example, if indoor unit (A) was started in fan mode and then indoor unit (B) was then operated in heating mode, indoor unit (A) would temporarily start operation in fan mode but when indoor unit (B) started operating in heating mode, the OPERATION indicator lamp (red) for indoor unit (A) would begin to flash (1 second on, 1 second off) and it would go into standby mode. Indoor unit (B) would continue to operate in heating mode.

Notice

Instructions relating to heating (*) are applicable only to "HEAT & COOL MODEL" (Reverse Cycle).

- *● During use of the heating mode, the outdoor unit will occasionally commence the defrost operation for brief periods. During the defrosting operation, if the user sets the indoor unit for heating again, the defrosting mode will continue, and the heating operation will begin after completion of defrosting, with the result that some time may be required before warm air is emitted.
- *● During use of the heating mode, the top of the indoor unit may become warm, but this is due to the fact that coolant is circulated through the indoor unit even when it is stopped; it is not a malfunction.

OPERATING TIPS

Instructions relating to heating (*) are applicable only to "HEAT & COOL MODEL" (Reverse Cycle).

Temperature and Humidity Range

Permissible ranges of temperature and humidity are as follows:

	Outdoor Temperature	Indoor	
		Temperature	Humidity
COOLING OPERATION	About 0 to 46 °C	About 18 to 32 °C	About 80 % or less If the unit is used for long periods under high-humidity conditions, condensation may form on the surface of the indoor unit, and drip onto the floor or other objects underneath.
*HEATING OPERATION	About -10 to 24 °C	About 30 °C or less	

- Acoustic Noise Information: The maximum sound pressure level is less than 70 dB (A) for both indoor unit and outdoor unit. According to IEC 704-1 and ISO 3744.
- If the air conditioner is operated under higher temperature conditions than those listed, the built-in protection circuit may operate to prevent internal circuit damage. Also, during Cooling and Dry modes, if the unit is used under conditions of lower temperatures than those listed above, the heat-exchanger may freeze, leading to water leakage and other damage.
- Do not use this unit for any purposes other than the Cooling, (*)Heating, Dehumidifying, and air-circulation of rooms in ordinary dwellings.
- When the outdoor temperature drops, the outdoor unit's fans may switch to Low Speed.
- If the unit is used for long periods under high-humidity conditions, condensation may form on the surface of the indoor unit, and drip onto the floor or other objects underneath. (About 80% or more)



FUJITSU GENERAL LIMITED
1116, Suenaga, Takatsu-ku, Kawasaki 213-8502, Japan