

ROOM AIR CONDITIONER WALL MOUNTED TYPE

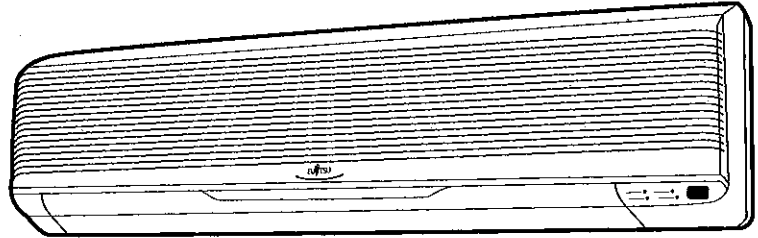

Indoor Unit

- AST20AS** - (COOLING MODEL)
- AST20RS** - (HEAT & COOL MODEL)
- AST24AS** - (COOLING MODEL)
- AST24RS** - (HEAT & COOL MODEL)
- AST30AS** - (COOLING MODEL)
- AST30RS** - (HEAT & COOL MODEL)

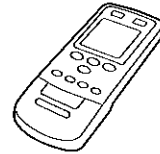

Supplied by

FUJITSU GENERAL (AUST.) PTY LIMITED

ACN 001229554

A Subsidiary of **FUJITSU GENERAL LIMITED**

HEAD OFFICE
SYDNEY

: E&F Rydalmere Business Park,
10-16 South Street, Rydalmere, N.S.W. 2116 TEL.[02] 9638 5199

MELBOURNE

: 2nd Floor, 1-3 Wellington Street, Windsor, VIC. 3181
[also all Tasmanian enquiries] TEL.[03] 9510 8652

BRISBANE

: 5th Floor, 301 Coronation Drive Milton, QLD. 4064
TEL.[07] 3367 2008

ADELAIDE

: 146 Fullarton Road, Rose Park, S.A. 5067 TEL.[08] 8364 0588

PERTH

: Unit 6, 103 Erindale Road Balcatta W.A. 6021 TEL.[08] 9345 2011

**KEEP THIS OPERATION MANUAL
FOR FUTURE REFERENCE**

CONTENTS

SAFETY PRECAUTIONS	2	MANUAL AUTO OPERATION	10
FEATURES AND FUNCTIONS	3	ADJUSTING THE DIRECTION OF	
NAME OF PARTS	4	AIR CIRCULATION	11
PREPARATION	6	SWING OPERATION	12
OPERATION	7	CLEANING AND CARE	13
TIMER OPERATION	9	TROUBLESHOOTING	14
SLEEP TIMER OPERATION	10	OPERATING TIPS	15

SAFETY PRECAUTIONS

WARNING!

- If the power supply cord of this air conditioner is damaged, it must be replaced by the manufacturer or its authorized service personnel only in order to avoid a safety hazard.

DANGER!

- Do not attempt to install this air conditioner by yourself.
- This unit contains no user-serviceable parts. Always consult authorized service personnel for repairs.
- When moving, consult authorized service personnel for disconnection and installation of the unit.
- Do not become excessively chilled by staying for lengthy periods in the direct cooling airflow.
- Do not insert fingers or objects into the outlet port or intake grilles.
- Do not start and stop air conditioner operation by disconnecting the power supply cord and so on.
- Take care not to damage the power supply cord.
- In the event of a malfunction (burning smell, etc.), immediately stop operation, turn off the circuit breaker, and consult authorized service personnel.

CAUTION!

- Provide occasional ventilation during use.
- Do not direct air flow at fireplaces or heating apparatus.
- Do not climb on, or place objects on, the air conditioner.
- Do not hang objects from the indoor unit.
- Do not set flower vases or water containers on top of air conditioners.
- Do not expose the air conditioner directly to water.
- Do not operate the air conditioner with wet hands.
- Do not pull power supply cord.
- Turn off power source when not using the unit for extended periods.
- Check the condition of the installation stand for damage.
- Do not place animals or plants in the direct path of the air flow.
- Do not drink the water drained from the air conditioner.
- Do not use in applications involving the storage of foods, plants or animals, precision equipment, or art works.
- Do not apply any heavy pressure to radiator fins.
- Operate only with air filters installed.
- Do not block or cover the intake grille and outlet port.
- Ensure that any electronic equipment is at least one metre away from either the indoor or outdoor units.
- Avoid installing the air conditioner near a fireplace or other heating apparatus.
- When installing the indoor and outdoor unit, take precautions to prevent access to infants.
- Do not use inflammable gases near the air conditioner.

FEATURES AND FUNCTIONS

AUTOMATIC OPERATION

● COOLING MODEL

Merely press the START/STOP button, and the unit will begin automatic operation in the Cooling or Dry mode as appropriate, in accordance with the thermostat setting and the actual temperature of the room.

● HEAT & COOL MODEL (REVERSE CYCLE)

Merely press the START/STOP button, and the unit will begin automatic operation in either the Heating, Cooling or Monitor modes as appropriate, in accordance with the thermostat setting and the actual temperature of the room.

SLEEP TIMER

● COOLING MODEL

When the SLEEP timer button is pressed during Cooling or Dry mode, the thermostat setting is gradually raised during the period of operation. When the set time is reached, the unit automatically turns off.

● HEAT & COOL MODEL (REVERSE CYCLE)

When the SLEEP timer button is pressed during Heating mode, the air conditioner's thermostat setting is gradually lowered during the period of operation; during Cooling or Dry mode, the thermostat setting is gradually raised during the period of operation. When the set time is reached, the unit automatically turns off.

WIRELESS REMOTE CONTROL UNIT

The WIRELESS REMOTE CONTROL UNIT allows convenient control of air conditioner operation.

OMNI-DIRECTIONAL AIR FLOW (SWING OPERATION)

Three-dimensional control over air direction swing is possible through dual use of both an UP/DOWN Air Direction Swing and RIGHT/LEFT Air Direction Swing. Since UP/DOWN Air Direction Flaps operate automatically according to the Operating mode of the unit, it is possible to set air direction based on the Operating mode.

REMOVABLE INTAKE GRILLE

The indoor unit's INTAKE GRILLE can be removed for easy cleaning and maintenance.

MILDEW-RESISTANT FILTER

The AIR FILTER has been treated to resist mildew growth, thus allowing cleaner use and easier care.

AIR CLEANING FILTER (Optional)

The optional Air Cleaning Filter uses an electrostatic principle to clean the air of fine particulate matter such as tobacco smoke and plant pollen.

NAME OF PARTS

Instructions relating to heating(*) are applicable only to "HEAT & COOL MODEL" (Reverse Cycle).

Fig. 1

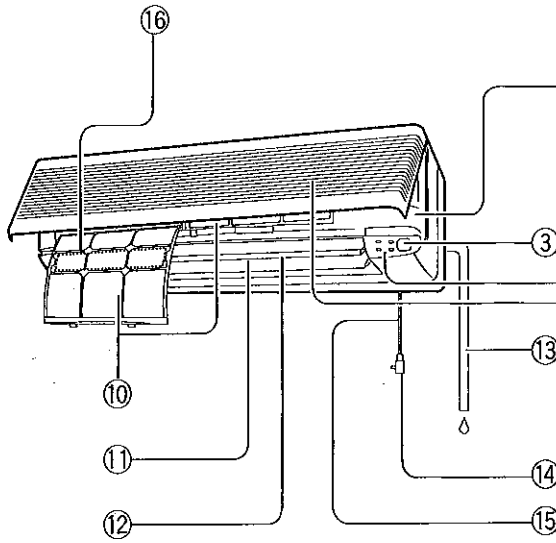

Fig. 2

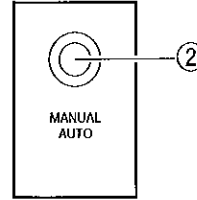

Fig. 3

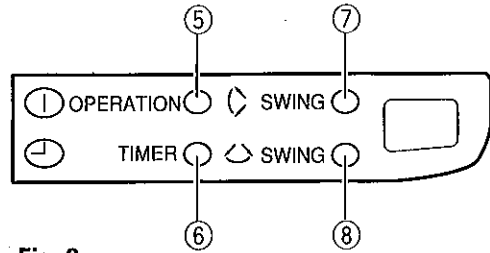

Fig. 4

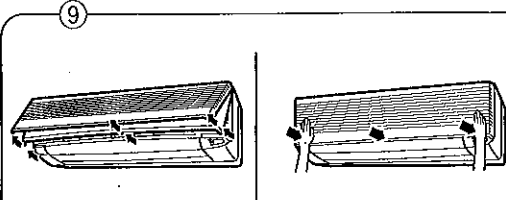

Fig. 5

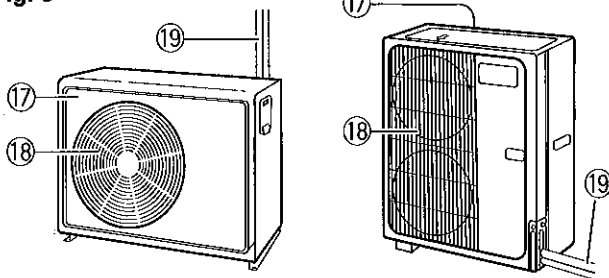

Fig. 6

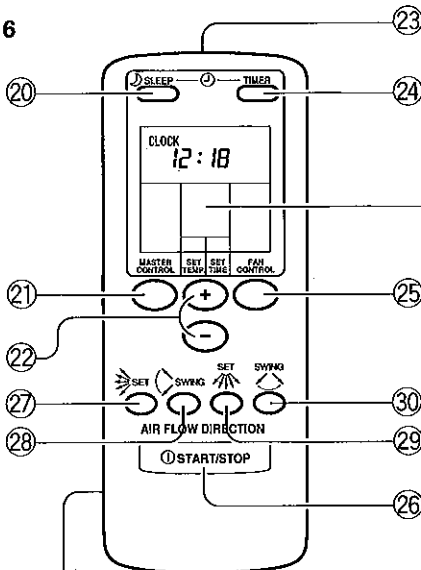

Fig. 7

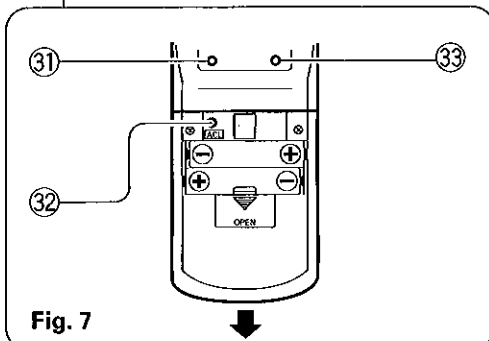

Fig. 8

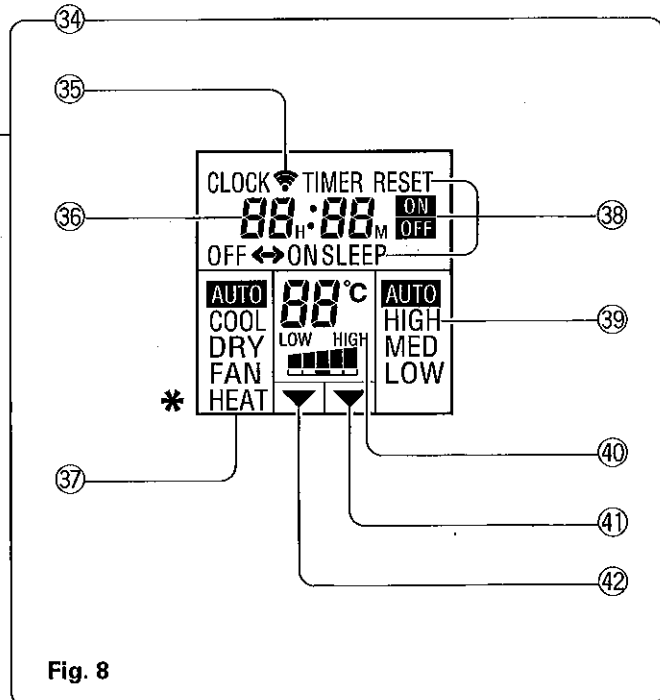

Fig. 1 Indoor Unit

- ① Operating Control Panel (Fig. 2)
- ② MANUAL AUTO button
- ③ Remote Control Signal Receiver
- ④ Indicator Lamps (Fig. 3)
 - ⑤ OPERATION Indicator Lamp (red)
 - ⑥ TIMER Indicator Lamp (green)
 - ⑦ SWING Indicator Lamp (orange)
(VERTICAL SWING)
 - ⑧ SWING Indicator Lamp (orange)
(HORIZONTAL SWING)
 - If the TIMER indicator Lamp flashes when the timer is operating, it indicates that a fault has occurred with the timer setting (See Page 15 Auto Restart).
- ⑨ Intake Grille (Fig. 4)
- ⑩ Air Filter
- ⑪ UP/DOWN Air Direction Flaps
- ⑫ RIGHT/LEFT Air Direction Louvers
(behind UP/DOWN Air Direction Flaps)
- ⑬ Drain Hose
- ⑭ Power Supply Plug
- ⑮ Power Supply Cord
- ⑯ Air Cleaning Filter (optional)

Fig. 5 Outdoor Unit

- ⑰ Intake Port
- ⑱ Outlet Port
- ⑲ Pipe Unit

Fig. 6 Remote Control Unit

- ⑳ SLEEP button
- ㉑ MASTER CONTROL button
- ㉒ SET TEMP./SET TIME buttons (⊕/⊖)
- ㉓ Signal Transmitter
- ㉔ TIMER button
- ㉕ FAN CONTROL button
- ㉖ START/STOP button
- ㉗ AIR FLOW DIRECTION
VERTICAL SET Button
- ㉘ AIR FLOW DIRECTION
VERTICAL SWING Button
- ㉙ AIR FLOW DIRECTION
HORIZONTAL SET Button
- ㉚ AIR FLOW DIRECTION
HORIZONTAL SWING Button

Rear side (Fig. 7)

- ㉛ TIME ADJUST button
- ㉜ ACL button
(located inside battery compartment)
- ㉝ TEST RUN button
 - This button is used when installing the conditioner, and should not be used under normal conditions, as it will cause the air conditioner's thermostat function to operate incorrectly.
 - If this button is pressed during normal operation, the unit will switch to test operation mode, and the Indoor Unit's OPERATION Indicator Lamp and TIMER Indicator Lamp will begin to flash simultaneously.
 - To stop the test operation mode, either press the TEST RUN button once again, or press the START/STOP button to stop the air conditioner.

㉞ Remote Control Unit Display (Fig. 8)

- ㉟ Transmit Indicator
- ㊱ Clock Display
- ㊲ Operating Mode Display
- ㊳ Timer Mode Display
- ㊴ Fan Speed Display
- ㊵ Temperature Set Display
- ㊶ Timer Set Indicator
- ㊷ Temperature Set Indicator

PREPARATION

Turn on the Power

- 1 Connect the Power Supply Plug (Fig. 1 ⑭) to an electrical outlet; in the case of a direct line connection, turn on the circuit breaker.**

Load Batteries (R03/LR03 × 2)

- 1 Press and slide the battery compartment lid on the reverse side to open it.**

Slide in the direction of the arrow while pressing the ▼ mark.

- 2 Insert batteries.**

Be sure to align the battery polarities (⊕/⊖) correctly.

- 3 Close the battery compartment lid.**

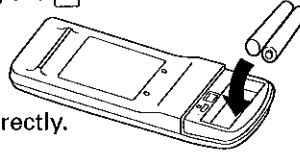

⚠ CAUTION!

- Take care to prevent infants from accidentally swallowing batteries.
- When not using the remote control unit for an extended period, remove the batteries to avoid possible leakage and damage to the unit.
- If leaking battery fluid comes in contact with your skin, eyes, or mouth, immediately wash with copious amounts of water, and consult your physician.
- Dead batteries should be removed quickly and disposed of properly, either by placing in a public battery collection receptacle, or by returning to appropriate authority.
- Do not attempt to recharge dry batteries.

Never mix new and used batteries, or batteries of different types. Batteries should last about one year under normal use. If the remote control unit's operating range becomes appreciably reduced, replace the batteries and press the ACL button with the tip of a ballpoint pen or other small object.

Set the Current time

- 1 Press the TIME ADJUST button (Fig. 7 ⑳).**
Use the tip of a ball-point pen or other small object to press the button.
- 2 Use the (⊕/⊖)SET TIME buttons (Fig. 6 ㉒) to adjust the clock to the current time.**
⊕ button: Press to advance the time.
⊖ button: Press to reverse the time.
(Each time the buttons are pressed, the time will be advanced/reversed in one-minute increments; hold the buttons depressed to change the time quickly in ten-minute increments.)
- 3 Press the TIME ADJUST button again.**
This completes the time setting and starts the clock.

To Use the Remote Control Unit

- The Remote Control Unit must be pointed at signal receiver (Fig. 1 ㉓) to operate correctly.
- Operating Range: About 7 meters.
- When a signal is properly received by the air conditioner, a beeping sound will be heard.
- If no beep is heard, press the Remote Control Unit button again.

Remote Control Unit Holder

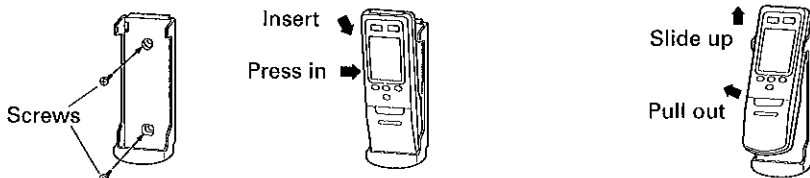

- ① Mount the Holder.**
- ② Set the Remote Control Unit.**
- ③ To remove the Remote Control Unit (when use at hand).**

OPERATION

Instructions relating to heating (*) are applicable only to "HEAT & COOL MODEL" (Reverse Cycle).

To Select Mode Operation

- 1 Press the START/STOP button (Fig. 6 26).**
The Indoor Unit's OPERATION Indicator lamp (red) (Fig. 3 5) will light. The air conditioner will start operation.
- 2 Press the MASTER CONTROL button (Fig. 6 21) to select the desired mode.**
Each time the button is pressed, the mode will change in the following order.

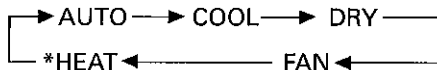

About three seconds later, the entire display will reappear.

To Set the Thermostat

Press the SET TEMP. buttons (Fig. 6 22).

- + button:** Press to raise the thermostat setting.
- button:** Press to lower the thermostat setting.

●Thermostat setting range:

AUTO	18 to 30°C
* Heating	16 to 30°C
Cooling/Dry	18 to 30°C

The thermostat cannot be used to set room temperature during the FAN mode (the temperature will not appear on the remote control unit's display).

About three seconds later, the entire display will reappear.

The thermostat setting should be considered a standard value, and may differ somewhat from the actual room temperature.

To Set the Fan Speed

Press the FAN CONTROL button (Fig. 6 25).

Each time the button is pressed, the fan speed changes in the following order:

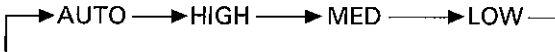

About three seconds later, the entire display will reappear.

When set to AUTO:

- * Heating :** Fan operates so as to optimally circulate warmed air. However, the fan will operate at very low speed when the temperature of the air issued from the indoor unit is low.
- Cooling :** As the room temperature approaches that of the thermostat setting, the fan speed becomes slower.
- Fan :** The fan alternately turns on and off; when on, the fan runs at the low fan speed.

The fan will operate at very low setting during Monitor operation and at the start of the Heating mode.

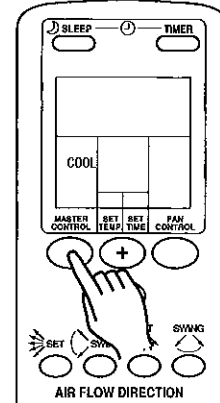

Example: When set to COOL.

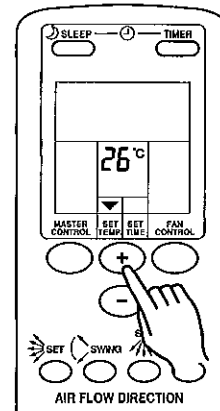

Example: When set to 26°C.

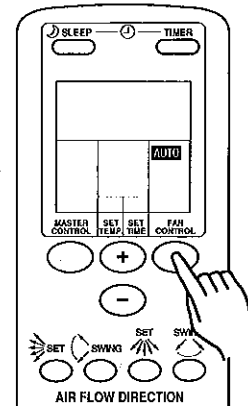

Example: When set to AUTO.

OPERATION

Instructions relating to heating (*) are applicable only to "HEAT & COOL MODEL" (Reverse Cycle).

To Stop Operation

Press the START/STOP button.

The OPERATION Indicator Lamp (red) (Fig. 3 ⑤) will go out.

About Mode Operation

AUTO:

COOLING MODEL

- When the room temperature is 2°C higher than the set temperature, the mode will switch between Cooling and Drying.
- During Drying mode operation, FAN setting is switched to LOW gentle cooling effect, and the room fan may stop rotating temporarily.
- If the mode automatically selected by the unit is not what you wish, see page 7 and select one of the mode operation (COOL, DRY, FAN).

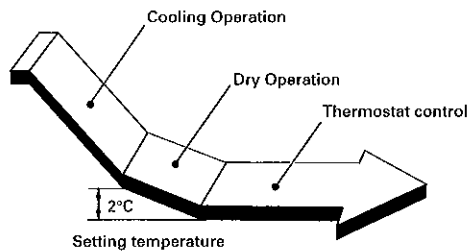

AUTO (* AUTO CHANGEOVER):

HEAT & COOL MODEL (Reverse cycle)

- When AUTO CHANGEOVER operation is selected, the air conditioner selects the appropriate operation mode (Cooling or Heating) in response to your room's temperature.
- When AUTO CHANGEOVER operation first selected, the fan will operate at very low speed for about one minute, during which time the unit detects the room conditions and selects the proper operating mode.
- When the air conditioner has adjusted your room's temperature to near the thermostat setting, it will begin monitor operation. In the monitor operation mode, the fan will operate at low speed. If the room temperature subsequently changes, the air conditioner will once again select the appropriate operation (Heating, Cooling) to adjust the temperature to the value set in the thermostat. (The monitor operation range is $\pm 2^\circ\text{C}$ relative to the thermostat setting.)
- If the mode automatically selected by the unit is not what you wish, see page 7 and select one of the mode operation (HEAT, COOL, DRY, FAN).

***Heating:**

- Use to warm your room.
- When Heating mode is selected, the air conditioner will operate at very low fan speed for about 3 to 5 minutes, after which it will switch to the selected fan setting. This period of time is provided to allow the indoor unit to warm up before begin full operation.
- When the room temperature is very low, frost may form on the outside unit, and its performance may be reduced. In order to remove such frost, the unit will automatically enter the defrost cycle from time to time. During Automatic Defrosting operation, the OPERATION indicator Lamp (red) will flash, and the heat operation will be interrupted.

Cooling:

- Use to cool your room.

Dry:

- Use for gently cooling while dehumidifying your room.
- You cannot heat the room during Dry mode.
- During Dry mode, the unit will operate at low speed; in order to adjust room humidity, the indoor unit's fan may stop from time to time. Also, the fan may operate at very low speed when detecting room humidity.
- Then fan speed cannot be changed manually when Dry mode has been selected.

Fan:

- Use to circulate the air throughout your room.

*** During Heating mode:**

Set the thermostat to a temperature setting that is higher than the current room temperature. The Heating mode will not operate if the thermostat is set lower than the actual room temperature.

During Cooling/Dry mode:

Set the thermostat to a temperature setting that is lower than the current room temperature. The Cooling and Dry modes will not operate if the thermostat is set higher than the actual room temperature (in Cooling mode, the fan alone will operate).

Drying Fan mode:

You can not use the unit to heat and cool your room.

TIMER OPERATION

Before using the timer function, be sure that the Remote Control Unit is set to the correct current time (See page 6).

To Use the ON timer or OFF timer

- 1 Press the START/STOP button (Fig. 6 ㉔)**
(if the unit is already operating, proceed to step 2).
The Indoor Unit's OPERATION Indicator lamp (red) (Fig. 3 ㉑) will light.
- 2 Press the TIMER button (Fig. 6 ㉒) to select the OFF timer or ON timer operation.**
Each time the button is pressed the timer function changes in the following order:

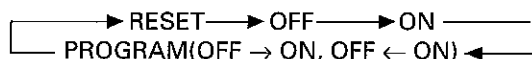

The indoor unit's TIMER Indicator lamp (green) (Fig. 3 ㉑) will light.

- 3 Use the SET TIME buttons (Fig. 6 ㉒) to adjust the desired OFF time or ON time.**
Set the time while the time display is flashing (the flashing will continue for about five seconds).

- ⊕ button: Press to advance the time.
- ⊖ button: Press to reverse the time.

About five seconds later, the entire display will reappear.

To Use the PROGRAM timer

- 1 Press the START/STOP button (Fig. 6 ㉔)**
(if the unit is already operating, proceed to step 2).
The Indoor Unit's OPERATION Indicator lamp (red) (Fig. 3 ㉑) will light.
- 2 Set the desired times for OFF timer and ON timer.**
See the section "To Use the ON timer or OFF timer" to set the desired mode and times.
About three seconds later, the entire display will reappear.
The indoor unit's TIMER Indicator lamp (green) (Fig. 3 ㉑) will light.
- 3 Press the TIMER button (Fig. 6 ㉒) to select the PROGRAM timer operation (either OFF → ON or OFF ← ON will display).**
The display will alternately show "OFF timer" and "ON timer", then change to show the time setting for the operation to occur first.
 - The PROGRAM timer will begin operation. (If the ON timer has been selected to operate first, the unit will stop operating at this point.)About five seconds later, the entire display will reappear.

About the PROGRAM timer

- The PROGRAM timer allows you to integrate OFF timer and ON timer operations in a single sequence. The sequence can involve one transition from OFF timer to ON timer, or from ON timer to OFF timer, within a twenty-four hour period.
- The first timer function to operate will be the one set nearest to the current time. The order of operation is indicated by the arrow in the Remote control Unit's display (OFF → ON, or OFF ← ON).
- One example of PROGRAM timer use might be to have the air conditioner automatically stop (OFF timer) after you go to sleep, then start (ON timer) automatically in the morning before you arise.

About the ON timer

- The timer function is designed to bring your room to a comfortable temperature by the set time; as a result, the unit automatically begins operation before the set time so that the room reaches the desired temperature by the time set on the timer ("Nice-Morning Timer").
- The hotter it is in summer, or the colder it is in winter, the earlier that operation will begin.
- * During Heating Operation from 45 to 10 minutes before set time.
During Cooling/Dry Operation ... from 20 to 10 minutes before set time.
During Fan Operation at the set time.

To Control the Timer

Use the TIMER button to select "TIMER RESET."
The air conditioner will return to normal operation.

To Change the Timer Settings

Perform steps 2 and 3.

To Stop Air Conditioner Operation while the Timer is Operating

Press the START/STOP button.

To Change Operating Conditions

If you wish to change operating conditions (Mode, Fan Speed, Thermostat Setting), after making the timer setting wait until the entire display reappears, then press the appropriate buttons to change the operating condition desired.

To Cancel the Timer

Use the TIMER button to select "TIMER RESET."
The air conditioner will return to normal operation.

To Change the Timer Settings

1. Follow the instructions given in the section "To Use the ON Timer or OFF Timer" to select the timer setting you wish to change.
2. Press the TIMER button to select either OFF → ON or OFF ← ON.

To Stop Air Conditioner Operation while the Timer is Operating

Press the START/STOP button.

To Change Operating Conditions

If you wish to change operating conditions (Mode, Fan Speed, Thermostat Setting), after making the timer setting wait until the entire display reappears, then press the appropriate buttons to change the operating condition desired.

SLEEP TIMER OPERATION

Unlike other timer functions, the SLEEP timer is used to set the length of time until air conditioner operation is stopped.

To Use the SLEEP timer

1 While the air conditioner is operating or stopped, press the SLEEP button (Fig. 6 ㉑).

The indoor unit's OPERATION Indicator lamp (red) (Fig. 3 ㉓) lights and the TIMER Indicator lamp (green) (Fig. 3 ㉔) light.

To Cancel the Timer:

Use the TIMER button to select "TIMER RESET"
The air conditioner will return to normal operation.

To Change the Timer Settings

Press the SLEEP button (Fig. 6 ㉑) once again and set the time using the SET TIME buttons (Fig. 6 ㉒).

Set the time while the Timer Mode Display is flashing (the flashing will continue about five seconds).

- ⊕ button: Press to advance the time.
- ⊖ button: Press to reverse the time.

To Stop the Air Conditioner During Timer Operation:

Press the START/STOP button.

About five seconds later, the entire display will reappear.

About the SLEEP timer

To prevent excessive warming or cooling during sleep, the SLEEP timer function automatically modifies the thermostat setting in accordance with the time setting. When the set time has elapsed, the air conditioner completely stops.

During Heating operation (HEAT & COOL MODEL (Reverse cycle) only):

When the SLEEP timer is set, the thermostat setting is automatically lowered 1°C every thirty minutes. When the thermostat has been lowered a total of 4°C, the thermostat setting at that time is maintained until the set time has elapsed, at which time the air conditioner automatically turns off.

During Cooling/Dry operation:

When the SLEEP timer is set, the thermostat setting is automatically raised 1°C every sixty minutes. When the thermostat has been raised a total of 2°C, the thermostat setting at that time is maintained until the set time has elapsed, at which time the air conditioner automatically turns off.

SLEEP timer setting

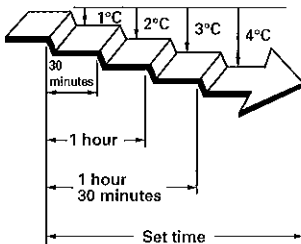

SLEEP timer setting

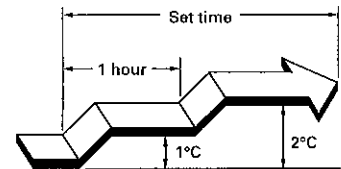

MANUAL AUTO OPERATION

Use the MANUAL AUTO operation in the event the Remote Control Unit is lost or otherwise unavailable.

How To Use the Main Unit Controls

Press the MANUAL AUTO button (Fig. 2 ㉑) on the main unit control panel.

To stop operation, press the MANUAL AUTO button once again. (Controls are located inside the Intake Grille.)

- When the air conditioner is operated with the controls on the Main Unit, it will operate under the same mode as the AUTO mode selected on the Remote Control Unit (see page 8).
- The fan speed selected will be "AUTO" and the thermostat setting will be 23°C.

ADJUSTING THE DIRECTION OF AIR CIRCULATION

Instructions relating to heating (*) are applicable only to "HEAT & COOL MODEL" (Reverse Cycle).

Vertical (up-down) direction of airflow is adjusted by pressing the Remote Control Unit's AIR FLOW DIRECTION VERTICAL SET button. Horizontal (right-left) direction of airflow is adjusted by pressing the Remote Control Unit's AIR FLOW DIRECTION HORIZONTAL SET button.

Vertical Air Direction Adjustment

Press the AIR FLOW DIRECTION VERTICAL SET button (Fig. 6 27).

Each time the button is pressed, the air direction range will change as follows:

① ↔ ② ↔ ③ ↔ ④ ↔ ⑤ ↔ ⑥ ↔ ⑦

Types of Air flow Direction Setting:

- ①,②,③,④ : During Cooling/Dry Modes
- ⑤,⑥,⑦ : * During Heating mode

The Remote Control Unit's display does not change.

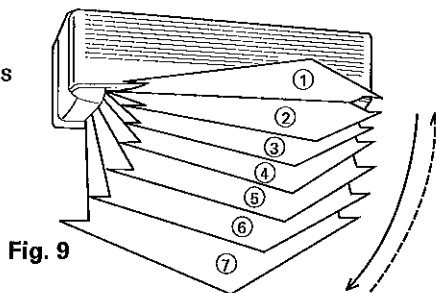

Fig. 9

- Use the air direction adjustments within the ranges shown above.
- The vertical airflow direction is set automatically as shown, in accordance with the type of operation selected.
 - During Cooling/Dry mode : Horizontal flow ①
 - * During Heating mode : Downward flow ⑦
- During AUTO mode operation, for the first minute after beginning operation, airflow will be horizontal ①; the air direction cannot be adjusted during this period.

⚠ DANGER!

- Never place fingers or foreign objects inside the outlet ports, since the internal fan operates at high speed and could cause personal injury.

- Always use the remote control unit's AIR FLOW DIRECTION button to adjust the UP/DOWN air direction flaps or RIGHT/LEFT air direction louvers. Attempting to move them manually could result in improper operation; in this case, stop operation and restart. The louvers should begin to operate properly again.
- During use of the Cooling and Dry modes, do not set the UP/DOWN air direction flaps in the Heating range (⑤ to ⑦) for long periods of time, since water vapor may condense near the outlet louvers and drops of water may drip from the air conditioner.
- When used in a room with infants, children, elderly or sick persons, the air direction and room temperature should be considered carefully when making settings.

Horizontal Air Direction Adjustment

Press the AIR FLOW DIRECTION HORIZONTAL SET button (Fig. 6 29).

Each time the button is pressed, the air direction range will change as follows:

① ↔ ② ↔ ③ ↔ ④ ↔ ⑤

The Remote Control Unit's display does not change.

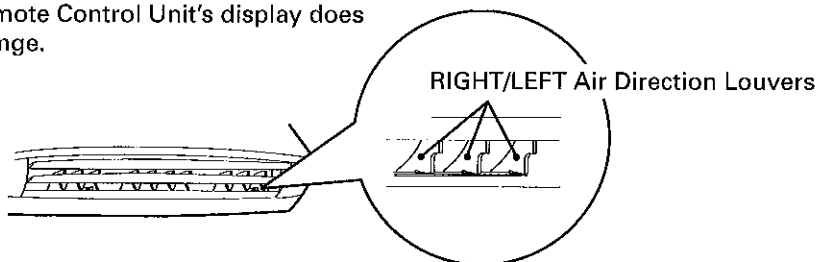

- Use the air direction adjustments within the ranges shown above.

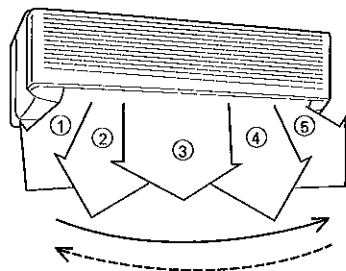

Fig. 10

SWING OPERATION

Begin air conditioner operation before performing this procedure

To select Vertical airflow SWING Operation

Press the **AIR FLOW DIRECTION VERTICAL SWING** button (Fig. 6 28).

The SWING indicator lamp (VERTICAL SWING) (Fig. 3 7) will light. In this mode, the UP/DOWN Air Direction Flaps will swing automatically to direct the air flow both up and down.

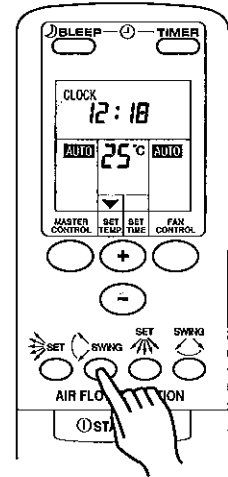

To Stop Vertical airflow SWING Operation

Press the **AIR FLOW DIRECTION VERTICAL SWING** button (Fig. 6 28) once again.

The SWING indicator lamp (VERTICAL SWING) (Fig. 3 7) will go out. Airflow direction will return to the setting before swing was begun.

About Swing Operation

- The range of swing is relative to the currently set airflow direction.

Air flow direction set	Range of swing
①	① to ③
②	① to ④
③	② to ⑤
④	③ to ⑥
⑤	④ to ⑦
⑥	⑤ to ⑦
⑦	① to ⑦ (All range)

Air direction range (See page 11, Fig. 9)

- If the swing range is not as desired, use the Remote Control Unit's AIR FLOW DIRECTION VERTICAL SET button to change the range of swing.
- The SWING Operation may stop temporarily when the air conditioner's fan is not operating, or when operating at very low speeds.
- During use of the Cooling and Dry modes, do not set the Air UP/DOWN Direction Flaps, in the Heating range (⑤ to ⑦) for long periods of time, since water vapor may condense near the outlet louvers and drops of water may drip from the air conditioner.

To select Horizontal airflow SWING Operation

Press the **AIR FLOW DIRECTION HORIZONTAL SWING** button (Fig. 6 30).

The SWING indicator lamp (HORIZONTAL SWING) (Fig. 3 8) will light. In this mode, the RIGHT/LEFT Air Direction Louvers will swing automatically to direct the airflow both right and left.

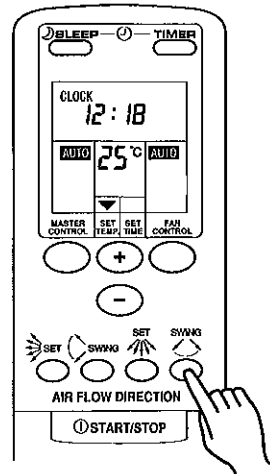

To Stop Horizontal airflow SWING Operation

Press the **AIR FLOW DIRECTION HORIZONTAL SWING** button (Fig. 6 30) once again.

The SWING indicator lamp (HORIZONTAL SWING) (Fig. 3 8) will go out. Airflow direction will return to the setting before swing was begun.

About Swing Operation

- The range of swing is relative to the currently set airflow direction.

Air flow direction set	Range of swing
①	① to ⑤ (All range)
②	① to ③
③	② to ④
④	③ to ⑤
⑤	① to ⑤ (All range)

Air direction range (See page 11, Fig. 10)

- If the swing range is not as desired, use the Remote Control Unit's AIR FLOW DIRECTION HORIZONTAL SET button to change the range of swing.
- The SWING Operation may stop temporarily when the air conditioner's fan is not operating, or when operating at very low speeds.

CLEANING AND CARE

CAUTION!

- Before cleaning the air conditioner, be sure to turn it off and disconnect the Power Supply Cord.
- Be sure the Intake Grille (Fig. 1 ⑨) is installed securely.
- When removing and replacing the air filters, be sure not to touch the heat exchanger, as personal injury may result.

Cleaning the Intake Grille

1. Remove the Intake Grille

- ① Place your fingers at both lower ends of the grille panel, and lift forward; if the Intake Grille seems to catch partway through its movement, continue lifting upward to remove.

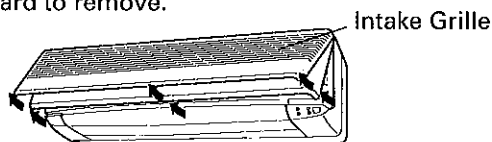

- ② Lift up the Intake Grille fully to remove.

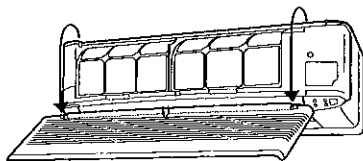

2. Clean with water.

Remove dust with a vacuum cleaner; wipe the unit with warm water, then dry with a clean, soft cloth.

3. Replace the Intake Grille.

- ① Holding the Intake Grille horizontally, fasten the two upper hooks on the unit.

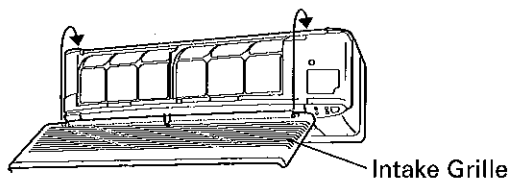

- ② Press the Intake Grille down at the lower sides to close.

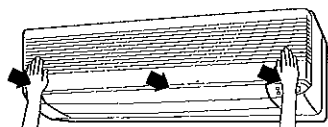

Cleaning the Air Filter

1. Open the Intake Grille, and remove the Air Filter.

Lift up the air filter's handle, disconnect the two lower tabs, and pull out.

Air filter handle

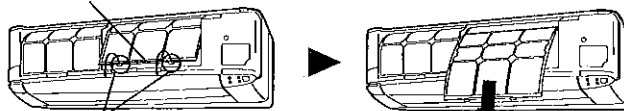

2. Remove dust with a vacuum cleaner or by washing.

After washing, allow to dry thoroughly in a shaded place.

3. Replace the Air Filter and close the Intake Grille.

- ① Align the sides of the Air Filter with the panel, and push in fully, making sure the two lower tabs are returned properly to their holes in the panel.

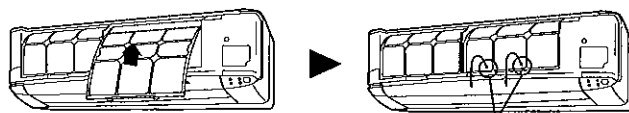

- ② Close the Intake Grille.

(For purposes of example, the illustration shows the unit without Intake Grille installed.)

- Dust can be cleaned from the Air Filter either with a vacuum cleaner, or by washing the filter in a solution of mild detergent and warm water. If you wash the filter, be sure to allow it to dry thoroughly in a shady place before reinstalling.
- If dirt is allowed to accumulate on the Air Filter, air flow will be reduced, lowering operating efficiency and increasing noise.
- During periods of normal use, the Air Filters should be cleaned every two weeks.

When using the optional Air Cleaning Filter

- Install the optional Air Cleaning Filter set as instructed (installation instructions are furnished with the Air Cleaning Filter set).

- When used for extended periods, the unit may accumulate dirt inside, reducing its performance. We recommend that the unit be inspected regularly, in addition to your own cleaning and care. For more information, consult authorized service personnel.
- When cleaning the unit's body, do not use water hotter than 40°C, harsh abrasive cleansers, or volatile agents like benzene or thinner.
- Do not expose the unit body to liquid insecticides or hairsprays.
- When shutting down the unit for one month or more, first allow the fan mode to operate continuously for about one-half day to allow internal parts to dry thoroughly.

TROUBLESHOOTING

Instructions relating to heating (*) are applicable only to "HEAT & COOL MODEL" (Reverse Cycle).



In the event of a malfunction (burning smell, etc.), immediately stop operation, disconnect the Power Supply Plug, and consult authorized service personnel.

Merely turning off the unit's power switch will not completely disconnect the unit from the power source. Always be sure to disconnect the Power Supply Plug or turn off your circuit breaker to ensure that power is completely off.

Before requesting service, perform the following checks:

	Symptom	Problem	See Page
NORMAL FUNCTION	Doesn't operate immediately:	<ul style="list-style-type: none"> ● If the unit is stopped and then immediately started again, the compressor will not operate for about 3 minutes, in order to prevent fuse blowouts. ● Whenever the Power Supply Plug is disconnected and then reconnected to a power outlet, the protection circuit will operate for about 3 minutes, preventing unit operation during that period. 	—
	Noise is heard:	<ul style="list-style-type: none"> ● During operation and immediately after stopping the unit, the sound of water flowing in the air conditioner's piping may be heard. Also, noise may be particularly noticeable for about 2 to 3 minutes after starting operation (sound of coolant flowing). ● During operation, a slight squeaking sound may be heard. This is the result of minute expansion and contraction of the front cover due to temperature changes. 	—
		*● During Heating operation, a sizzling sound may be heard occasional. This sound is produced by the Automatic Defrosting operation.	15
	Smells:	<ul style="list-style-type: none"> ● Some smell may be emitted from the indoor unit. This smell is the result of room smells (furniture, tobacco, etc.) which have been taken into the air conditioner. 	—
	Mist or steam are emitted:	<ul style="list-style-type: none"> ● During Cooling or Dry operation, a thin mist may be seen emitted from the indoor unit. This results from the sudden Cooling of room air by the air emitted from the air conditioner, resulting in condensation and misting. 	—
		*● During Heating operation, the outdoor unit's fan may stop, and steam may be seen rising from the unit. This is due to Automatic Defrosting operation.	15
	Airflow is weak or stops.	*● When Heating operation is started, fan speed is temporarily very low, to allow internal parts to warm up.	—
		*● During Heating operation, if the room temperature rises above the thermostat setting, the outdoor unit will stop, and the indoor unit will operate at very low fan speed. If you wish to warm the room further, set the thermostat for a higher setting.	
		*● During Heating operation, the unit will temporarily stop operation (between 7 and 15 minutes) as the Automatic Defrosting mode operates. During Automatic Defrosting operation, the OPERATION indicator lamp will flash.	15
		● The fan may operate at very low speed during Dry operation or when the unit is monitoring the room's temperature.	7
		● In the monitor AUTO operation, the fan will operate at very low speed.	7
	Water is produced from the outdoor unit.	*● During Heating operation, water may be produced from the outdoor unit due to Automatic Defrosting operation.	15

TROUBLESHOOTING

Instructions relating to heating (*) are applicable only to "HEAT & COOL MODEL" (Reverse Cycle).

	Symptom	Items to check	See Page
CHECK ONCE MORE	Doesn't operate at all:	<ul style="list-style-type: none"> ● Is the Power Supply Plug disconnected from its outlet? ● Has there been a power failure? ● Has a fuse blown out, or a circuit breaker been tripped? 	—
		<ul style="list-style-type: none"> ● Is the timer operating? 	9 to 10
	Poor Cooling (or *Heating) performance:	<ul style="list-style-type: none"> ● Is the air filter dirty? ● Air the air conditioner's intake grille or outlet port blocked? ● Did you adjust the room temperature settings (thermostat) correctly? ● Is there a window or door open? ● In the case of Cooling operation, is a window allowing bright sunlight to enter? (Close the curtains.) ● In the case of Cooling operation, are there heating apparatus and computers inside the room, or are there too many people in the room? 	—
	The unit operates differently from the remote control unit's setting:	<ul style="list-style-type: none"> ● Are the Remote Control Unit's batteries dead? ● Are the Remote Control Unit's batteries loaded properly? 	6

If the problem persists after performing these checks, or if you notice burning smells, or the TIMER Indicator lamp (Fig. 3 ⑥) flashes, immediately stop operation, disconnect the Power Supply Plug (Fig. 1 ⑭), and consult authorized service personnel.

OPERATING TIPS

Operation and Performance

*Heating Performance

- This air conditioner operates on the heat-pump principle, absorbing heat from outdoor air and transferring that heat indoors. As a result, the operating performance is reduced as outdoor air temperature drops. If you feel that insufficient heating performance is being produced, we recommend you use this air conditioner in conjunction with another kind of heating appliance.
- Heat-pump air conditioners heat your entire room by recirculating air throughout the room, with the result that some time may be required after first starting the air conditioner until the room is heated.

*Microcomputer-controlled Automatic Defrosting

- When using the Heating mode under conditions of low outdoor air temperature high humidity, frost may form on the outdoor unit, resulting in reduced operating performance.
In order to prevent this kind of reduced performance, this unit is equipped with a Microcomputer-controlled Automatic Defrosting function. If frost forms, the air conditioner will temporarily stop, and the defrosting circuit will operate briefly (for about 7 to 15 minutes).
During Automatic Defrosting operation, the OPERATION Indicator Lamp (red) will flash.

In Event of Power Interruption

AUTO Restart

- The air conditioner power has been interrupted by a power failure. The air conditioner will then restart automatically in its previous mode when the power is restored.
- If a power failure occurs during TIMER operation, the timer will be reset and the unit will begin (or stop) operation at the new time setting. In the event that this (kind of timer fault occurs the TIMER Indicator Lamp (green) will flash (see Page. 5)).
- Use of other electrical appliances (electric shaver, etc.) or nearby use of a wireless radio transmitter may cause the air conditioner to malfunction. In this event, temporarily disconnect the Power Supply Plug, reconnect it, and then use the Remote Control Unit to resume operation.

OPERATING TIPS

Instructions relating to heating (*) are applicable only to "HEAT & COOL MODEL" (Reverse Cycle).

Temperature and Humidity Range

		Cooling/Dry Mode	*Heating Mode
Outdoor temperature	COOLING MODEL	About 18 to 52°C (AST20AS, AST24AS Models) About 0 to 52°C (AST30AS Models)	—
	HEAT & COOL MODEL (Reverse Cycle)	About 0 to 52°C	About 0 to 21°C
Indoor temperature		About 18 to 32°C	About 30°C or less
Indoor humidity		About 80% or less If the unit is used for long periods under high-humidity conditions, condensation may form on the surface of the indoor unit, and drip onto the floor or other objects underneath.	—

- If the air conditioner is used under higher temperature conditioner than those listed, the built-in protection circuit may operate to prevent internal circuit damage. Also, during Cooling and Dry modes, if the unit is used under conditions of lower temperature than those listed above, the heat-exchanger may freeze, leading to water leakage and other damage.
- Do not use this unit for any purposes other than the Cooling, (*)Heating, Dehumidifying, and air-circulation of rooms in ordinary dwellings.



FUJITSU GENERAL LIMITED
1116, Suenaga, Takatsu-kū, Kawasaki 213, Japan