



# FUJITSU

## OPERATING MANUAL



### AIR CONDITIONER DUCT TYPE

### ART90 Series

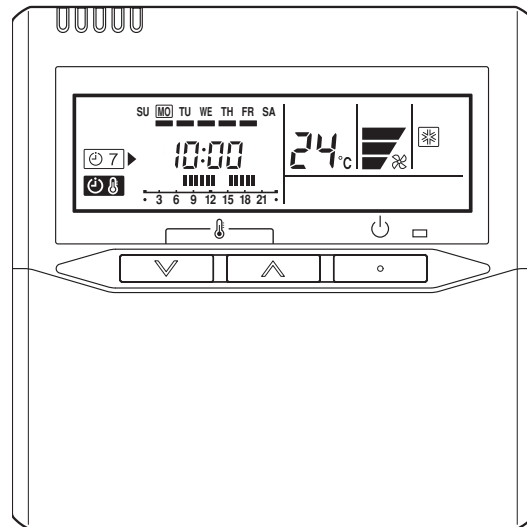

KEEP THIS OPERATION MANUAL  
FOR FUTURE REFERENCE

FUJITSU GENERAL LIMITED

P/N9365350034









# CONTENTS

SAFETY PRECAUTIONS .....	1	TEMPERATURE SET BACK TIMER .....	8
NAME OF PARTS .....	2	OPERATING TIPS .....	9
PREPARATORY OPERATION .....	3	CARE AND MAINTENANCE .....	10
OPERATION .....	3	SELF-DIAGNOSIS .....	10
TIMER FUNCTIONS .....	5	TROUBLESHOOTING .....	11
ON/OFF TIMER .....	5	TEMPERATURE AND HUMIDITY RANGE .....	12
WEEKLY TIMER .....	6		

# SAFETY PRECAUTIONS

- Before using the appliance, read these "PRECAUTIONS" thoroughly and operate in the correct way.
- The instructions in this section all relate to safety; be sure to maintain safe operating conditions.
- "DANGER", "WARNING" and "CAUTION" have the following meanings in these instructions:

 <b>DANGER!</b>	This mark indicates procedures which, if improperly performed, are most likely to result in the death of or serious injury to the user or service personnel.
 <b>WARNING!</b>	This mark indicates procedures which, if improperly performed, might lead to the death or serious injury of the user.
 <b>CAUTION!</b>	This mark indicates procedures which, if improperly performed, might possibly result in personal harm to the user, or damage to property.

** DANGER!**

- Do not attempt to install this air conditioner by yourself.
- This unit contains no user-serviceable parts. Always consult authorized service personnel for repairs.
- When moving, consult authorized service personnel for disconnection and installation of the unit.
- Do not become over-exposed to cold air by staying in the direct path of the air flow of the air conditioner for extended periods of time.
- Do not insert fingers or objects into the outlet port or intake grilles.
- Do not start and stop air conditioner operation by turning off the electrical breaker and so on.
- In the event of a malfunction (burning smell, etc.), immediately stop operation, turn off the electrical breaker, and consult authorized service personnel.

** CAUTION!**

- Provide occasional ventilation during use.
- Do not direct air flow at fireplaces or heating apparatus.
- Do not climb on, or place objects on the air conditioner.
- Do not expose the air conditioner directly to water.
- Do not operate the air conditioner with wet hands.
- Turn off power source when not using the unit for extended periods.
- Always turn off the electrical breaker whenever cleaning the air conditioner or changing the air filter.
- Connection valves become hot during heating; handle with care.
- Check the condition of the installation stand for damage.
- Do not place animals or plants in the direct path of the air flow.
- When restarting after a long period of disuse in the winter, do:  
Turn the power switch on at least 12 hours before starting the unit.
- Do not drink the water drained from the air conditioner.
- Do not use in applications involving the storage of foods, plants or animals, precision equipment, or art works.
- Do not apply any heavy pressure to radiator fins.
- Operate only with air filters installed.
- Do not block or cover the intake grille and outlet port.
- Ensure that any electronic equipment is at least one metre away from either the indoor or outdoor units.
- Avoid installing the air conditioner near a fireplace or other heating apparatus.
- When installing the indoor and outdoor unit, take precautions to prevent access to infants.
- Do not use inflammable gases near the air conditioner.

## NAME OF PARTS

**Fig. 1 Indoor Unit**

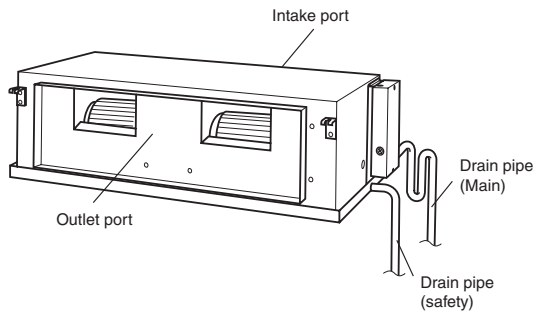

**Fig. 2 Outdoor Unit**

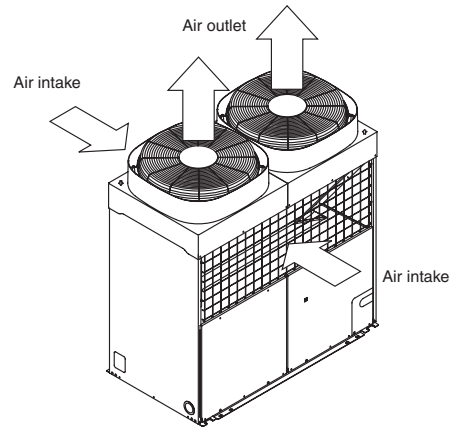

### Electrical Breaker

- Install this with the power supply chain during on-site installation.

**Fig. 3 Remote controller**

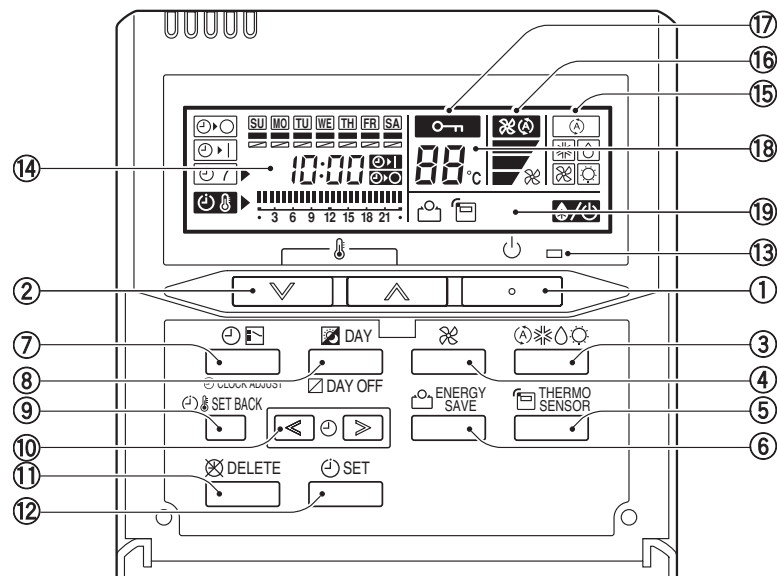

- |                                    |                           |
|------------------------------------|---------------------------|
| ① Start/Stop Button                | ⑫ SET Button              |
| ② Set Temperature Button           | ⑬ Operation Lamp          |
| ③ Master Control Button            | ⑭ Timer and Clock Display |
| ④ Fan Control Button               | ⑮ Operation Mode Display  |
| ⑤ THERMO SENSOR Button             | ⑯ Fan Speed Display       |
| ⑥ ENERGY SAVE Button               | ⑰ Operation Lock Display  |
| ⑦ Timer Mode (CLOCK ADJUST) Button | ⑱ Temperature Display     |
| ⑧ DAY (DAY OFF) Button             | ⚡/🔌 Defrost Display       |
| ⑨ SET BACK Button                  | 📄 Thermo Sensor Display   |
| ⑩ Set Time Button                  | 📄 Energy Save Display     |
| ⑪ DELETE Button                    |                           |

# PREPARATORY OPERATION

## Set the current day and time

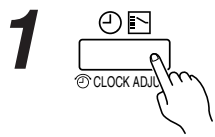

**1** Press the timer mode (CLOCK ADJUST) button for 2 seconds or more. The time display on the remote controller will flash.

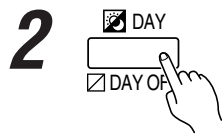

**2** Press the DAY button and select the current day. A  appears around the selected day.

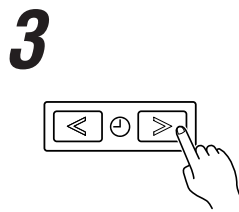
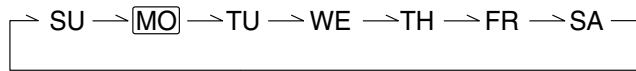

**3** Press the set time buttons to set the current time. Press repeatedly to adjust the current time in 1-minute increments. Press and hold to adjust the current time in 10-minute increments.

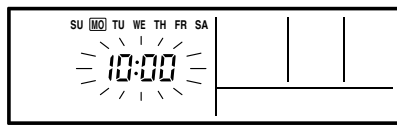

ex. Monday 10:00

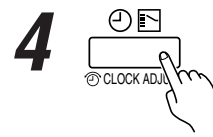

**4** Press again to end.

# OPERATION

Instructions relating to heating are applicable only to "HEAT & COOL MODEL" (Reverse Cycle).

## To start/stop operation

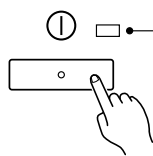

Press the start/stop button.

**Operation lamp**  
 Air conditioner ON: Lit brightly  
 Air conditioner OFF: Not lit

## To set the operation mode

### ● Operation mode setting

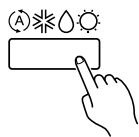

Press the master control button to set the operation mode. If DRY is selected, the fan speed will be set to AUTO.

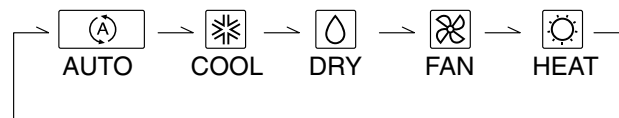

### ● Room temperature setting

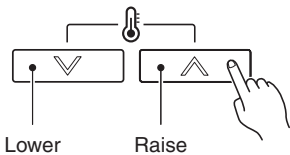

Press the set temperature buttons to set the room temperature.

**Temperature setting range**  
 AUTO ..... 18 to 30 °C  
 COOL/DRY ..... 18 to 30 °C  
 HEAT ..... 16 to 30 °C

### ● Fan speed setting

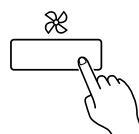

Follow the instruction in the "CUTTING THE JUMPER LINE" section of the INSTALLATION INSTRUCTION SHEET and change the Fan speed display.



# OPERATION

### Energy save

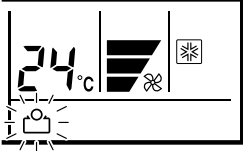

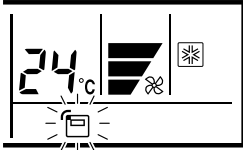
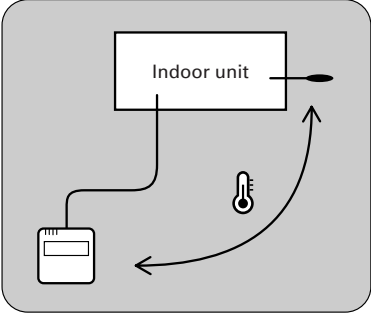

Press the ENERGY SAVE button to start or stop the energy-saving air conditioner operation.  
For details on the function, refer to page 9.

### Room temperature sensor selection







Press the THERMO SENSOR button to select whether the room temperature is detected at the indoor unit (remote sensor) or the remote controller.

When the  thermo sensor display appears, the room temperature is detected at the remote controller.

#### NOTES

- This function is locked at the factory. In order to detect the room temperature correctly, consult authorized service personnel when using this function.
- If this function is locked, the location where the room temperature is detected cannot be changed and the  mark flashes when the THERMO SENSOR button is pushed.

### Child lock function

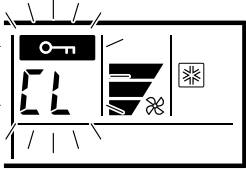
Press the DAY (DAY OFF) button and SET button simultaneously for 2 seconds or more to activate the child lock function and lock all buttons on the remote controller. Press the buttons again for 2 seconds or more to deactivate the child lock function.

When the child lock function is activated, the  mark appears. If any button is pressed during the child lock, the **CL** display flashes.

## TIMER FUNCTIONS



### OFF timer (See page 5.)

Use this timer function to stop air conditioner operation. The timer operates and air conditioner operation stops after the set time has passed. The timer can be set up to 24 hours in advance.



### ON timer (See page 5.)

Use this timer function to start air conditioner operation. The timer operates and air condition operation starts after the set time has passed. The timer can be set up to 24 hours in advance.



### WEEKLY timer (See page 6.)

Use this timer function to set operating times for each day of the week. Use the DAY OFF setting to switch off timed operation for a selected day in the coming week. Because all days can be set together, the weekly timer can be used to repeat the timer settings for all of the days.



### Temperature SET BACK timer (See page 8.)

Use this timer function to change the set temperature in the operation times set for each day of the week. This can be used together with other timer settings.

## ON/OFF TIMER

### To set the ON/OFF timer

1



Press the timer mode button to select the ON timer or OFF timer.

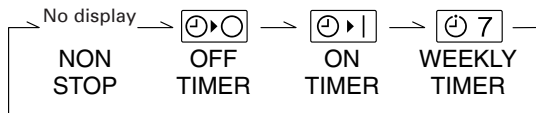

2

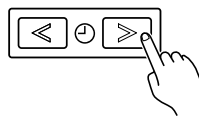

From 1 to 24 hours

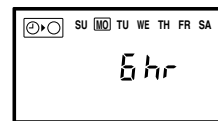

ex. OFF timer set for 6 hours

Press the set time buttons to set the time. After the time is set, the timer will start automatically. The amount of time until the OFF timer operates that is displayed on the timer display decreases as time passes.

### ● To cancel



- Press the DELETE button to cancel the timer mode.
- The timer mode can also be canceled by changing the timer mode using the timer mode button.

# WEEKLY TIMER

**Weekly timer setting**

**1**

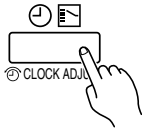

Press the timer mode button to select the weekly timer.

**2**

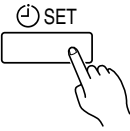

Press the SET button for 2 seconds or more.

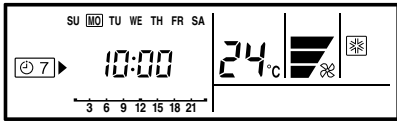

**3** ● Day of the week setting

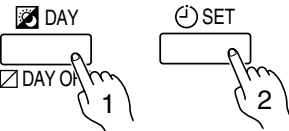

Press the DAY button to select the day of the week, and then press the SET button to confirm the setting.

\* For ALL, all of the days can be set together when a  appears around each day.

\* ALL → SU → MO → TU → WE → TH → FR → SA

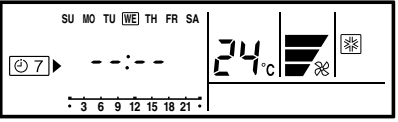

**4** ● Time setting

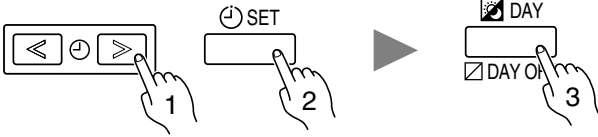

Press the set time buttons to set the time, and then press the SET button to confirm the setting and proceed to the next ON or OFF time setting. Up to two ON and OFF times can be set per day. Press the DAY button to complete the time setting and return to the day of the week setting.

ON-1 → OFF-1 → ON-2 → OFF-2

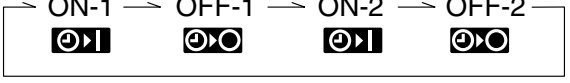

When the operating time is set, the  mark appears.

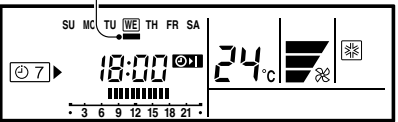

ex. The timer is set for 7:00-18:00.

**5**

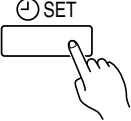

Repeat steps **3** and **4**. To complete the weekly timer settings, press the SET button for 2 seconds or more.

● To delete the operating time



If the DELETE button is pressed during steps **3** or **4**, the operating time for the selected day will be deleted. If all the days are selected, the operating times for all of the days will be deleted.

**i NOTES**

- The operating time can be set in 30-minute increments only.
- The OFF time can be carried over to the next day.
- The ON timer and the OFF timer functions cannot be set using the weekly timer. Both an ON and OFF time must be set.

# WEEKLY TIMER

**WEEKLY timer operation**

**● To start**

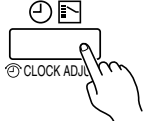

When the weekly timer is selected, the timer starts automatically.

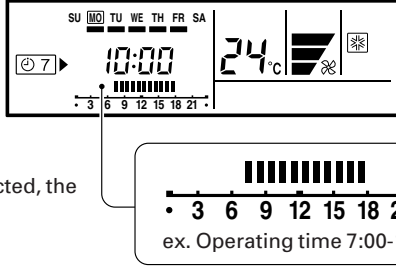





The operating time for the current day is displayed.

**● To cancel**



- Press the DELETE button to cancel the timer mode.
- The timer mode can also be canceled by changing the timer mode using the timer mode button.

**To set the DAY OFF (for a holiday)**

- 1**  SET  
During the weekly timer, press the SET button for 2 seconds or more to set the day.
- 2**  DAY  
 DAY OFF  
Select the day to set the DAY OFF.
- 3**  DAY  
 DAY OFF  
Press the DAY (DAY OFF) button for 2 seconds or more to set the DAY OFF.
- 4**  SET  
Press the SET button for 2 seconds or more to complete the DAY OFF setting.

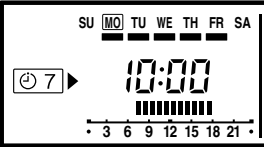
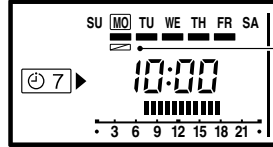
ex. The DAY OFF is set for Monday.

mark: Indicates the DAY OFF

**● To cancel**  
Follow the same procedures as those for setup.

**i NOTES**

- The DAY OFF setting is only available for days for which weekly settings already exist.
- If the operating time carries over to the next day (during a next day setting), the effective DAY OFF range will be set as shown below.

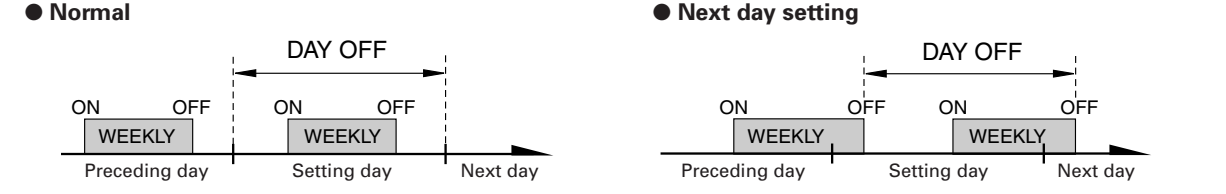

- The DAY OFF setting can only be set one time. The DAY OFF setting is canceled automatically after the set day has passed.



# TEMPERATURE SET BACK TIMER

## Temperature SET BACK timer setting

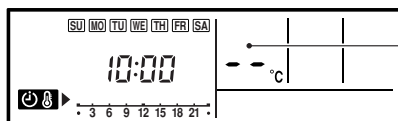
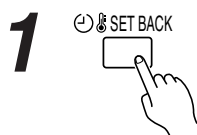

If there is no existing SET BACK temperature setting, "--" will be displayed for the temperature.

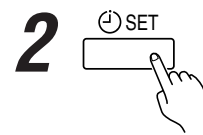

Press the SET BACK button to change to the SET BACK confirmation display. The SET BACK operating time and the set temperature will be displayed.

Press the SET button for 2 seconds or more.

3

### Day setting

### Operating time setting

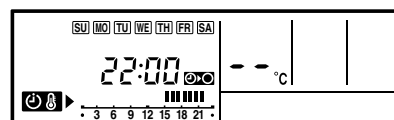
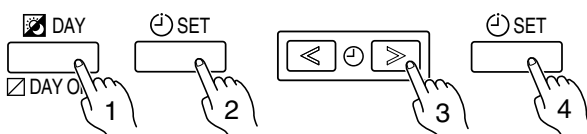

ex. When setting all days together

Follow the same procedures to set the operating time as those for the weekly timer. The DELETE button is also used as described in the procedures for the weekly timer.

4

### Temperature setting

Press the set temperature buttons to set the temperature. (The temperature setting range is the same as the range for the operation mode.)

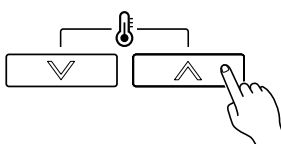

ex. Operating time 15:00-22:00

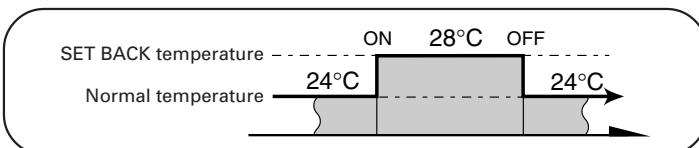

5

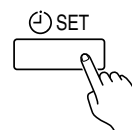

Repeat steps 3 and 4. Press the SET button for 2 seconds or more to complete the temperature SET BACK timer settings.

## Temperature SET BACK timer operation

### To start

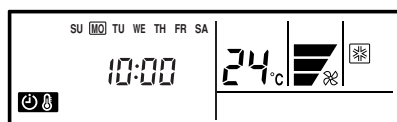

ex. Display during SET BACK timer operation (The operating time will not be displayed.)

Press the SET BACK button. The SET BACK confirmation display appears for 5 seconds, and then the timer starts automatically.

### To cancel

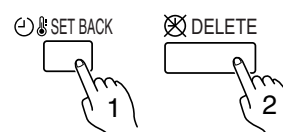

Press the SET BACK button, and then press the DELETE button while the SET BACK confirmation display is displayed. Even if the SET BACK button is pressed again, the SET BACK timer will be canceled.

## NOTES

- The SET BACK timer only changes the set temperature, it cannot be used to start or stop air conditioner operation.
- The SET BACK timer can be set to operate up to two times per day but only one temperature setting can be used.
- The SET BACK timer can be used together with the ON, OFF, and weekly timer functions.
- The SET BACK operating time is displayed only in the SET BACK confirmation display. (Refer to step 1 for the SET BACK confirmation display.)

## OPERATING TIPS

Instructions relating to heating are applicable only to "HEAT & COOL MODEL" (Reverse Cycle).

### Mode operation: AUTO

#### COOLING MODEL

- When the room temperature is 2 °C higher than the set temperature, the mode will switch between Cooling and Drying.
- When in DRY operating mode, FAN will stop when the room temperature becomes the same as the set temperature or below.

#### HEAT & COOL MODEL (Reverse Cycle)

##### Auto changeover function

- When AUTO CHANGEOVER is selected, the air conditioner selects the appropriate operation mode (Cooling or Heating) according to your room's present temperature.
- When AUTO CHANGEOVER is first selected, the fan will operate at stop for about one minute while the unit determines the current conditions of the room and accordingly selects the proper operation mode.
- When the air conditioner has adjusted your room's temperature to near the thermostat setting, it will begin monitor operation. In the monitor operation mode, the fan will operate at stop. If the room temperature subsequently changes, the air conditioner will once again select the appropriate operation (Heating, Cooling) to adjust the temperature to the value set in the thermostat. (The monitor operation range is  $\pm 2$  °C relative to the thermostat setting.)

### AUTO restart

- Should the power supply to the air conditioner be interrupted by a power failure, the air conditioner will restart automatically in the previously selected mode once the power is restored.
- Use of other electrical appliances (electric shaver, etc.) or nearby use of a wireless radio transmitter may cause the air conditioner to malfunction. In this event, temporarily turn off the circuit breaker turn it on again and then use the remote controller to resume operation.

### Heating performance

- This air conditioner operates on the heat-pump principle, absorbing heat from outdoor air and transferring that heat indoors. As a result, the operating performance is reduced as outdoor air temperature drops. If you feel that insufficient heating performance is being produced, we recommend you to use this air conditioner in conjunction with another kind of heating appliance.
- Heat-pump air conditioners heat your entire room by recirculating air throughout the room, with the result that some time may be required after first starting the air conditioner until the room is heated.

### Energy save

- The energy conservation mode (ENERGY SAVE) raises the set temperature slightly in the cooling mode and lowers the set temperature in the heating mode to economically control the operation of the unit.
- If you press the ENERGY SAVE button while the unit is in the timer mode, the unit will go into the conservation mode when the unit starts with the timer.
- If you turn off the air conditioner while in the conservation mode, the mode will be shut off.
- The temperature set on the remote controller will not change if the energy save mode is used.

#### During cooling operation

When the ENERGY SAVE is pressed, the thermostat setting is automatically raised 1 °C every 60 minutes, until the thermostat is raised a total of 2 °C.

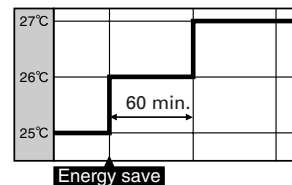

#### During heating operation

When the ENERGY SAVE is pressed, the thermostat setting is automatically lowered 1 °C every 30 minutes, until the thermostat is lowered a total of 4 °C.

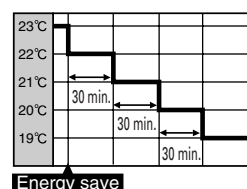

### Hot start (for heating)

The indoor unit prevents cold drafts when heating operation begins.

The indoor unit fan does not operate until the heat exchanger reaches the set temperature.

### Defrosting (for heating)

When the outdoor temperature is low and the humidity high, frost will collect on the outdoor unit, reducing heater efficiency. When this happens, the computer will automatically start the defrost cycle. During the defrost cycle, the indoor fan will shut down and  will be displayed on the remote controller. It will take anywhere from 4 to 15 minutes before the air conditioner starts up again.

### Group Control

One remote controller can control up to 16 air conditioners. All of the air conditioners will be operated with the same settings.

### Dual Remote Controllers (optional)

An additional remote controller can be added up to the maximum of two remote controllers. Either remote controller can control the air conditioner. However, the timer functions cannot be used at the slave unit.

### Commercial Mode

With this jumper line cut, the air conditioner cancels prevention control of cool air at Heating mode or fan-cut during the monitoring status at Auto mode, and it outputs the air of set fan speed. Commercial mode does not apply to DRY mode and it operates as per normal. \*Refer to the INSTALLATION INSTRUCTION SHEET for commercial mode setting.

## CARE AND MAINTENANCE

### ⚠ CAUTION!

Before cleaning the unit, be sure to stop the unit and power supply. (Turn off the electrical breaker.)

### Cleaning the air filter

If dirt is allowed to collect in the air filter, the airflow will be reduced, leading to reduced performance, and increased operation noise. Be sure to clean the filters regularly.

### How to clean

Use a vacuum cleaner to remove dust and dirt from the air filter, or wash in a synthetic detergent. After washing, dry in a shaded place, then reinstall.

- When used for extended periods, the unit may accumulate dirt inside, reducing its performance. We recommend that the unit be inspected regularly, in addition to your own cleaning and care. For more information, consult authorized service personnel.
- When cleaning the unit's body, do not use water hotter than 40 °C, harsh abrasive cleansers, or volatile agents like benzene or thinner.
- Do not expose the unit body to liquid insecticides or hairspray.
- If the unit will not be operated for a period of one month or more, be sure to allow the inner parts of the unit to dry thoroughly, in advance, by operating the unit in fan mode for half a day.

## SELF-DIAGNOSIS

When the error indication "E:EE" is displayed, inspection of the air conditioning system is necessary. Please consult authorized service personnel.

**1**

Stop the air conditioner operation.

**2**

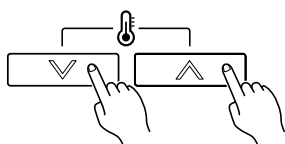

Press the set temperature buttons  $\wedge$  /  $\vee$  simultaneously for 5 seconds or more to start the self-diagnosis.

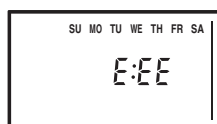

ex. Error display

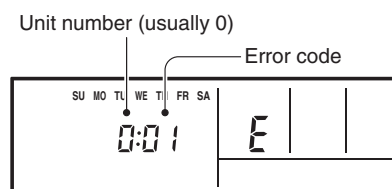

ex. Self-diagnosis check

**3**

Press the set temperature buttons simultaneously for 5 seconds or more to stop the self-diagnosis.





## TROUBLESHOOTING

Instructions relating to heating are applicable only to "HEAT & COOL MODEL" (Reverse Cycle).

### **⚠ WARNING!**

**In the event of a malfunction (burning smell, etc.), immediately stop operation, turn off the electrical breaker, and consult authorized service personnel.  
Merely turning off the unit's power switch will not completely disconnect the unit from the power source.  
Always be sure to turn off the electrical breaker to ensure that power is completely off.**

Before requesting service, perform the following checks:

	Symptom	Problem	See Page
NORMAL FUNCTION	Doesn't operate immediately:	<ul style="list-style-type: none"> <li>● If the unit is stopped and then immediately started again, the compressor will not operate for about 3 minutes, in order to prevent fuse blowouts.</li> <li>● Whenever the electrical breaker is turned off then on again, the protection circuit will operate for about 3 minutes, preventing unit operation during that period.</li> </ul>	—
	Noise is heard:	<ul style="list-style-type: none"> <li>● During operation and immediately after stopping the unit, the sound of water flowing in the air conditioner's piping may be heard. Also, noise may be particularly noticeable for about 2 to 3 minutes after starting operation (sound of coolant flowing).</li> </ul>	—
		<ul style="list-style-type: none"> <li>● During Heating operation, a sizzling sound may be heard occasionally. This sound is produced by the Automatic Defrosting operation.</li> </ul>	9
	Smells:	<ul style="list-style-type: none"> <li>● Some smell may be emitted from the indoor unit. This smell is the result of room smells (furniture, tobacco, etc.) which have been taken into the air conditioner.</li> </ul>	—
	Mist or steam are emitted:	<ul style="list-style-type: none"> <li>● During Cooling, a thin mist may be seen emitted from the indoor unit. This results from the sudden Cooling of room air by the air emitted from the air conditioner, resulting in condensation and misting.</li> </ul>	—
		<ul style="list-style-type: none"> <li>● During Heating operation, the outdoor unit's fan may stop, and steam may be seen rising from the unit. This is due to Automatic Defrosting operation.</li> </ul>	9
	Air flow is stopped:	<ul style="list-style-type: none"> <li>● When Heating operation starts, the fan stops temporarily to allow internal parts to warm up.</li> <li>● During Heating operation, if the room temperature rises above the thermostat setting, the indoor and the outdoor unit will stop. If you wish to warm the room further, set the thermostat for a higher setting.</li> </ul>	—
		<ul style="list-style-type: none"> <li>● During Heating operation, the unit will temporarily stop operation (between 2 and 16 minutes) as the Automatic Defrosting mode operates. During Automatic Defrosting operation, /⏻ will be shown on the remote controller display.</li> </ul>	9
		<ul style="list-style-type: none"> <li>● The fan may stop when the unit is monitoring the room's temperature.</li> </ul>	—
	Water is produced from the outdoor unit:	<ul style="list-style-type: none"> <li>● During Heating operation, water may be produced from the outdoor unit due to Automatic Defrosting operation.</li> </ul>	9
 thermo sensor display on the remote controller is flashing:	<ul style="list-style-type: none"> <li>● The room temperature sensor may be malfunctioning. Please consult authorized service personnel.</li> </ul>	—	





## TROUBLESHOOTING

	Symptom	Items to check	See Page
CHECK ONCE MORE	Doesn't operate at all:	<ul style="list-style-type: none"> <li>● Has there been a power failure?</li> <li>● Has a fuse blown out, or a circuit breaker been tripped?</li> </ul>	—
		<ul style="list-style-type: none"> <li>● Is the timer operating?</li> </ul>	5 to 7
	Poor Cooling (or Heating) performance:	<ul style="list-style-type: none"> <li>● Is the air filter dirty?</li> <li>● Are the air conditioner's intake grille or outlet port blocked?</li> <li>● Did you adjust the room temperature settings (thermostat) correctly?</li> <li>● Is there a window or door open?</li> <li>● In the case of Cooling operation, is a window allowing bright sunlight to enter? (Close the curtains.)</li> <li>● In the case of Cooling operation, are there heating apparatus and computers inside the room, or are there too many people in the room?</li> </ul>	—

If the problem persists after performing these checks, or if you notice burning smells, stop operation immediately, turn off the electrical breaker, and consult with authorized service personnel.

## TEMPERATURE AND HUMIDITY RANGE

Permissible ranges are as follows:

Cooling	Outdoor temperature: About 0 to 46 °C
	Indoor temperature: About 18 °C to 30 °C
	Indoor humidity: Below approximately 80 %. If the air conditioner is used continuously for many hours, water may condense on the surface and drip.
Heating	Outdoor temperature: About -10 to 21 °C
	Indoor temperature: About below 30 °C

If the unit is used under higher temperature conditions than those noted here, the automatic protection circuit may operate, interrupting the operation. If the unit is used under lower temperature conditions than those noted here, the heat exchanger may freeze, causing water leakage or other malfunction.

- Do not use the air conditioner for any purpose other than room cooling, room heating, or fan.



Dotted lines for text entry







**FUJITSU GENERAL LIMITED**  
 1116, Suenaga, Takatsu-ku, Kawasaki 213-8502, Japan

