

OPERATING MANUAL

AIR CONDITIONER

DUCT TYPE

Indoor Unit

ART36AL(3)H

ART36RL(3)H

ART45AL(3)H

ART45RL(3)H

ART60AL(3)

ART60RL(3)

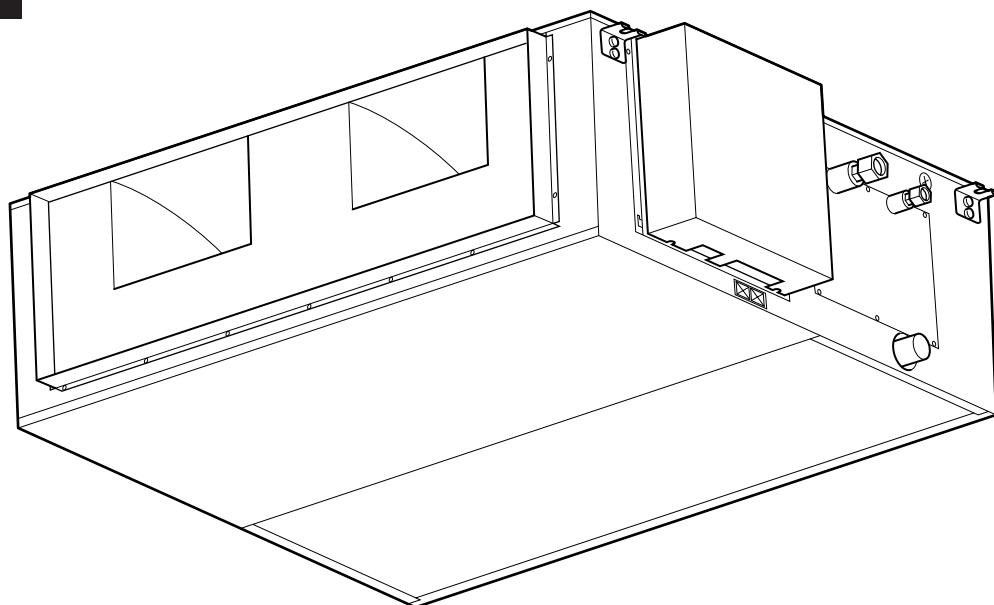

Outdoor Unit

AOT36AC(3)

AOT36RC(3)

AOT45AC(3)

AOT45RC(3)

AOT60AB(3)

AOT60RB(3)



KEEP THIS OPERATION MANUAL
FOR FUTURE REFERENCE

CONTENTS

SAFETY PRECAUTIONS	3	CARE AND MAINTENANCE	10
NAME OF PARTS	4	ERRORS AND SELF DIAGNOSIS	10
PREPARATION	6	OPERATING TIPS	11
OPERATION	6	SYSTEM OPERATION	12
TIMER OPERATION	8	TROUBLESHOOTING	13
ENERGY SAVE OPERATION	9		

SAFETY PRECAUTIONS

- Before using the appliance, read these "PRECAUTIONS" thoroughly and operate in the correct way.
- The instructions in this section all relate to safety; be sure to maintain safe operating conditions.
- "CAUTION" and "DANGER" have the following meanings in these instructions:

 DANGER!	This mark indicates procedures which, if improperly performed, might lead to the death or serious injury of the user.
 CAUTION!	This mark indicates procedures which, if improperly performed, might possibly result in personal harm to the user, or damage to property.

DANGER!

- Do not attempt to install this air conditioner by yourself.
- This unit contains no user-serviceable parts. Always consult authorized service personnel for repairs.
- When moving, consult authorized service personnel for disconnection and installation of the unit.
- Do not become over-exposed to cold air by staying in the direct path of the airflow of the air conditioner for extended periods of time.
- Do not insert fingers or objects into the outlet port or intake grilles.
- Do not start and stop air conditioner operation by turning off the electrical breaker and so on.
- In the event of a malfunction (burning smell, etc.), immediately stop operation, turn off the electrical breaker, and consult authorized service personnel.

CAUTION!

- Provide occasional ventilation during use.
- Do not direct air flow at fireplaces or heating apparatus.
- Do not climb on, or place objects on, the air conditioner.
- Do not expose the air conditioner directly to water.
- Do not operate the air conditioner with wet hands.
- Turn off power source when not using the unit for extended periods.
- Always turn off the electrical breaker whenever cleaning the air conditioner or changing the air filter.
- Connection valves become hot during Heating; handle with care.
- Check the condition of the installation stand for damage.
- Do not place animals or plants in the direct path of the air flow.
- When restarting after a long period of disuse in the winter, do:
Turn the power switch on at least 12 hours before starting the unit.
- Do not drink the water drained from the air conditioner.
- Do not use in applications involving the storage of foods, plants or animals, precision equipment, or art works.
- Do not apply any heavy pressure to radiator fins.
- Operate only with air filters installed.
- Do not block or cover the intake grille and outlet port.
- Ensure that any electronic equipment is at least one metre away from either the indoor or outdoor units.
- Avoid installing the air conditioner near a fireplace or other heating apparatus.
- When installing the indoor and outdoor unit, take precautions to prevent access to infants.
- Do not use inflammable gases near the air conditioner.

NAME OF PARTS

Instructions relating to heating(*) are applicable only to "HEAT & COOL MODEL" (Reverse Cycle).

Fig. 1

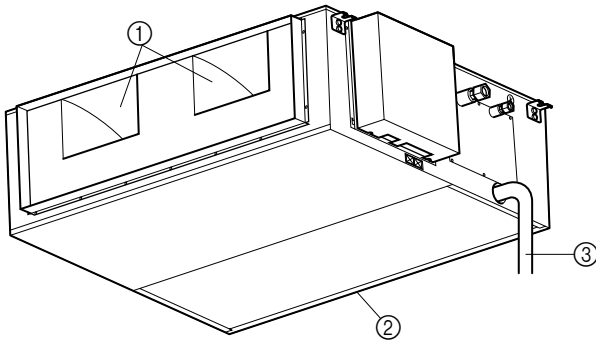

Fig. 3

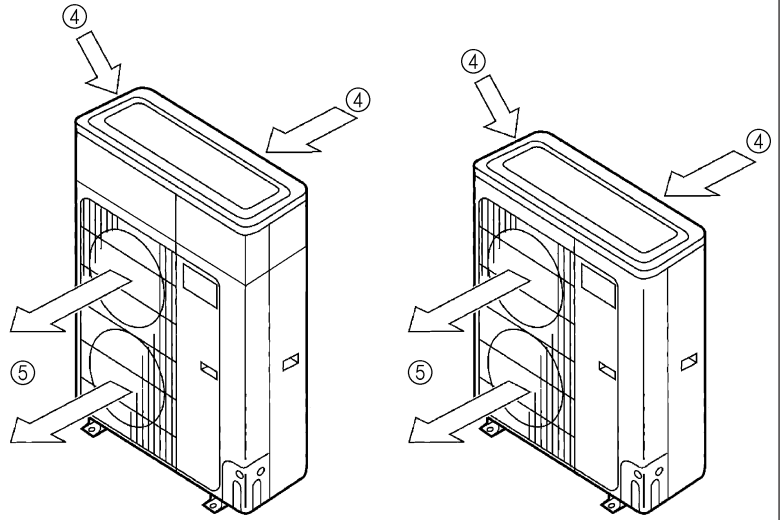

Fig. 2

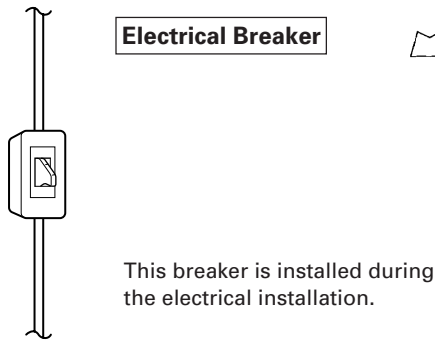
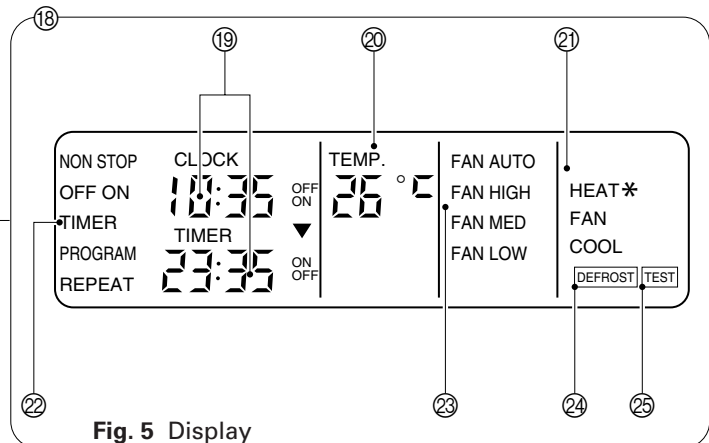
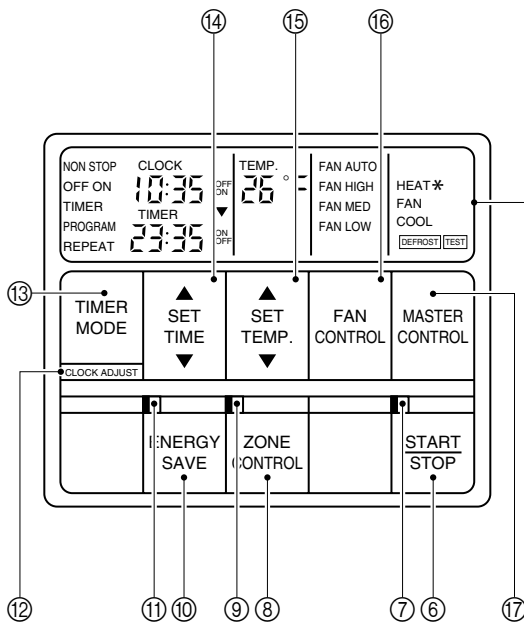

Fig. 4



For explanatory purposes, the figure showing the remote controller display shows all possible displays. The actual display shows only that area that is being adjusted or used.

Fig. 1 Indoor Unit

- ① Outlet Port
- ② Intake Port
- ③ Drain Hose

Fig. 3 Outdoor Unit

- ④ Intake Port
- ⑤ Outlet Port

Fig. 4 Remote Controller

- ⑥ START/STOP Button
- ⑦ Operation Lamp
- ⑧ ZONE CONTROL Button
- ⑨ ZONE CONTROL Lamp
- ⑩ ENERGY SAVE Button
- ⑪ ENERGY SAVE Lamp
- ⑫ CLOCK ADJUST Button
- ⑬ TIMER MODE Button
- ⑭ SET TIME Button (▲ / ▼)
- ⑮ SET TEMP. Button (▲ / ▼)
- ⑯ FAN CONTROL Button
- ⑰ MASTER CONTROL Button
- ⑱ Remote Controller Display (Fig.5)
- ⑲ Clock Display (CLOCK/TIMER)
- ⑳ Set Temperature Display (TEMP.)
- ㉑ Operation Mode Display
- ㉒ Timer Mode Display
- ㉓ Fan Speed Display
- ㉔ DEFROST Display
- ㉕ TEST Display

PREPARATION

Set the Current Time

- 1 Press the **CLOCK ADJUST** button for more than three seconds.

The current time display will flash.

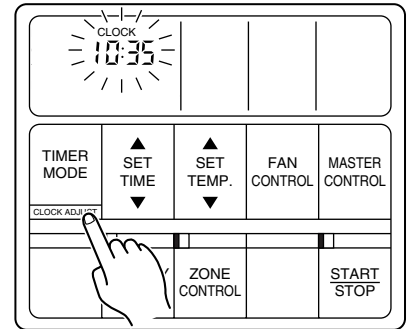

- 2 Press the **SET TIME** button and set the time.

▲: Use to advance the time forward.

▼: Use to turn the time back.

(Press once to move the time 1 minute; hold down and the time will move 10 minutes at a time.)

The current time display will flash.

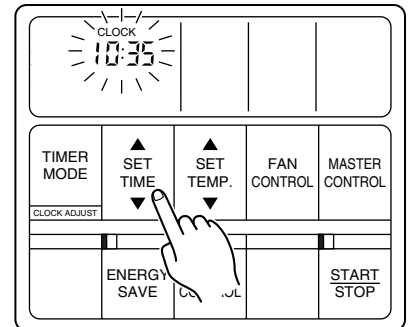

- 3 Press the **CLOCK ADJUST** button again.

The current time display will stop flashing.

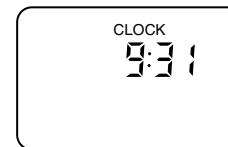

Example: Set the time to 9:31.

OPERATION

Instructions relating to heating (*) are applicable only to "HEAT & COOL MODEL" (Reverse Cycle).

To Select Mode Operation

- 1 Press the **START/STOP** button.

The unit will start and the operation lamp will light up.

- 2 Press the **MASTER CONTROL** button to select the desired mode.

Each time the button is pressed, the mode will change in the following order.

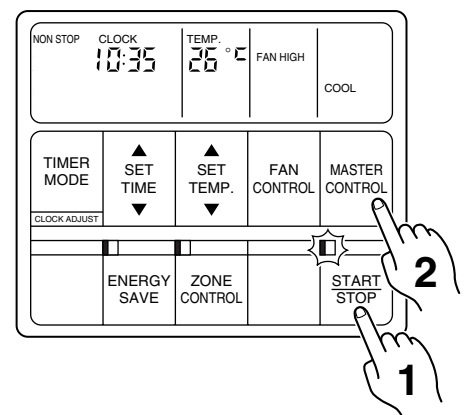
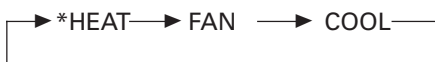

Example: When set to COOL.

To Set the Thermostat

Press the SET TEMP. button.

- ▲ : Press to raise the thermostat setting.
- ▼ : Press to lower the thermostat setting.

● Thermostat setting range:

- * Heating 16 to 30°C
- Cooling 18 to 30°C

The thermostat cannot be used to set room temperature during the FAN mode (the temperature will not appear on the remote controller's display).

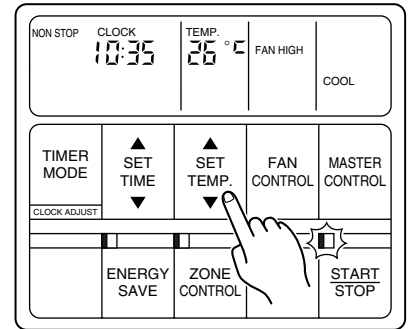

Example: When set to 26°C.

The thermostat setting should be considered a standard value, and may differ somewhat from the actual room temperature.

To Set the Fan Speed

Press the FAN CONTROL button.

Each time the button is pressed, the fan speed changes in the following order:



● When set to AUTO.

- *Heating : The fan speed will vary with room conditions.
- Cooling : The fan speed will vary with room conditions.
- Fan : The fan speed will automatically be set on MED.

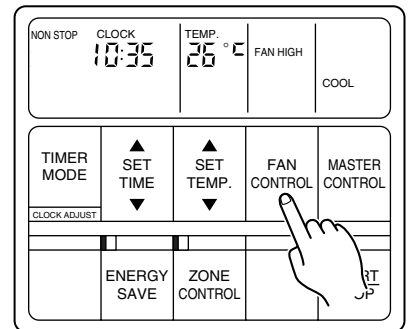

Example: When Set to HIGH.

To Stop Operation

Press the START/STOP button.

The display contents disappear and only the current time is displayed.

About Mode Operation

*Heating

- Always set the temperature higher than the current room temperature. If it is set lower than the current room temperature, heating will not start.
- For about 3 to 5 minutes after starting heating, the fan will operate very slowly, then switch to the selected fan setting. This period allows the indoor unit's heat-exchanger to perform before emitting warm air.
- During defrosting (see page 11), the heating mode will be temporarily interrupted. **DEFROST** will be shown on the remote controller display.

Cooling

- Always set the temperature lower than the current room temperature. If it is set higher than the current room temperature, the unit will not enter the cooling mode and only the fan will operate.

Fan

- The room temperature cannot be adjusted in the FAN mode. (The room temperature is not displayed on the remote controller.)

TIMER OPERATION

Press the START/STOP button; after the unit starts operation perform the following procedure:

OFF Timer / ON Timer

1 Press the TIMER MODE button and display either OFF Timer or ON Timer.

The timer will start operating. (If you set the ON timer, the air conditioner will stop operating).

Each time the button is pressed the timer function changes in the following order:

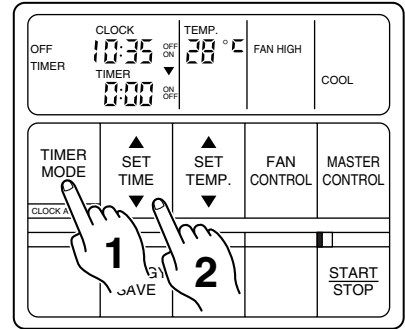
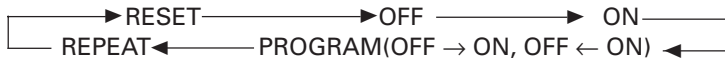

2 Press the SET TIME button and set the timer time.

▲ : Use to advance the time forward.

▼ : Use to turn the time back.

(Press once to move the time 1 minute; hold down and the time will move 10 minutes at a time.)

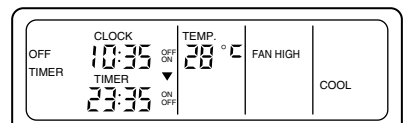

Example: Setting the OFF TIMER to 23:35.

PROGRAM Timer/REPEAT Timer

1 Setting the timer time.

Follow the instructions given in the section "OFF Timer / ON Timer" and set the times for the ON timer and OFF timer modes.

2 Press the TIMER MODE button until the "PROGRAM" or "REPEAT" mode display is shown.

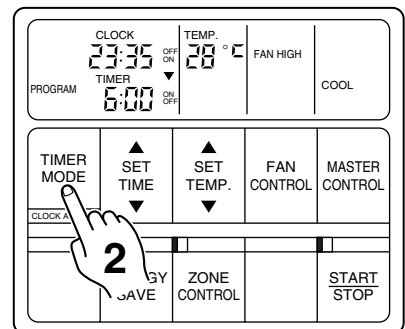

Example:

If the OFF timer is set at 23:35 and the ON timer at 6:00, and the unit is in the PROGRAM timer mode. (Select the REPEAT timer mode, "REPEAT" is shown on the display.)

About Timer Operation

PROGRAM Timer

- Combines the OFF timer and the ON timer for one cycle.(OFF → ON, or OFF ← ON)
- Starts operation from the OFF timer or the ON timer, whichever is closer to the current time.

REPEAT Timer

- Combines the operation of the OFF timer and the ON timer (the cycle described in the PROGRAM timer above) so they repeat the same cycle every day.
- Starts operation from the OFF timer or the ON timer, whichever is closer to the current time.

To confirm or Change Settings Before Starting Operation

- **To confirm settings**
Press the TIMER MODE button once. (The timer setting information will be displayed for 15 seconds after the TIMER MODE button is pressed.)
- **To change settings**
Confirm the settings as noted above, then press the SET TIME button and TIMER MODE button as necessary to change the desired timer setting. (The timer settings will be displayed for 15 seconds after the button is pressed.)
- After confirming or changing the settings, press the START/STOP button to start operation.

To Change the Timer Setting During Operation

- **OFF Timer / ON Timer**
Press the SET TIME button and set the timer time.
- **PROGRAM Timer / REPEAT Timer**
 1. Follow the instructions given in the section "OFF Timer/ON Timer" to display the timer setting you wish to change.
 2. Press the TIMER MODE button to display either "OFF → ON" or "OFF ← ON".

To Change the Timer Mode During Operation

Press the TIMER MODE button and set the unit to the desired mode.

To Cancel the Timer Mode During Timer Operation

Press the TIMER MODE button and set the display to "NON STOP" (the unit will switch to non-stop operation).

To Stop Operation During Use of Timer Mode

Press the START/STOP button.

ENERGY SAVE OPERATION

Instructions relating to heating(*) are applicable only to "HEAT & COOL MODEL" (Reverse Cycle).

To Use the ENERGY SAVE

Press the ENERGY SAVE button.

The unit will run in the ENERGY SAVE mode.

To Stop the ENERGY SAVE

Press the ENERGY SAVE button one more time.

The ENERGY SAVE mode will be turned off.

The ENERGY SAVE light goes off, and the unit will return to the former operating conditions.

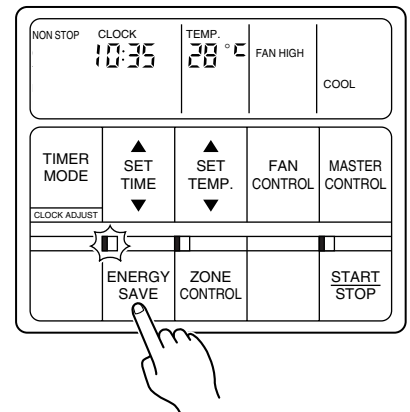

About the ENERGY SAVE

- The energy conservation mode (ENERGY SAVE) raises the set temperature slightly in the cooling mode and lowers the set temperature in the heating mode, using a computer program to economically control the operation of the unit.
- If you press the ENERGY SAVE button while the air conditioner is on, it will change to the conservation mode. If you press the ENERGY SAVE button while the unit is in the timer mode (ON timer, PROGRAM timer, or REPEAT timer), the unit will go into the conservation mode when the unit starts with the timer.
- If you turn off the air conditioner while in the conservation mode, the mode will be shut off.
- The temperature set on the remote controller will not change if the energy save mode is used.

■ *When Heating

After the ENERGY SAVE button is pressed, the set temperature will be lowered about 1°C every 30 minutes. When it has lowered a total of 2°C, then it will hold that temperature.

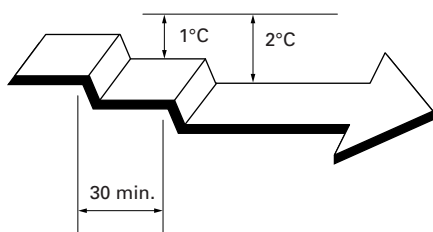

▲ Set to the ENERGY SAVE mode.

■ When Cooling

After the ENERGY SAVE button is pressed, the set temperature will be raised about 0.5°C every 30 minutes. When it has gone up a total of 1°C, then it will hold that temperature.

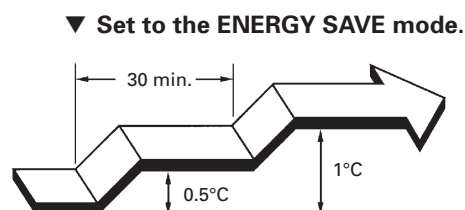

▼ Set to the ENERGY SAVE mode.

CARE AND MAINTENANCE



CAUTION!

- Before cleaning the unit, be sure to stop the unit and disconnect the power supply.
- Turn off the electrical breaker.
- A fan operates at high speed inside the unit, and personal injury could result.

Installing the Air Filter

Be sure the filter is always installed in the inlet air grille of the indoor unit.



Filters can be purchased through your local dealer.

Cleaning the Air Filter

If dirt is allowed to collect in the air filter, the airflow will be reduced, leading to reduced performance, and increased operation noise. Be sure to clean the filters regularly.

How to Cleaning

Use a vacuum cleaner to remove dust and dirt from the air filter, or wash in a synthetic detergent. After washing, dry in a shaded place, then reinstall.

- When used for extended periods, the unit may accumulate dirt inside, reducing its performance. We recommend that the unit be inspected regularly, in addition to your own cleaning and care. For more information, consult authorized service personnel.
- When cleaning the unit's body, do not use water hotter than 40°C, harsh abrasive cleansers, or volatile agents like benzene or thinner.
- Do not expose the unit body to liquid insecticides or hairsprays.
- If the unit will not be operated for a period of one month or more, be sure to allow the inner parts of the unit to dry thoroughly, in advance, by operating the unit in fan mode for half a day.

ERRORS AND SELF DIAGNOSIS

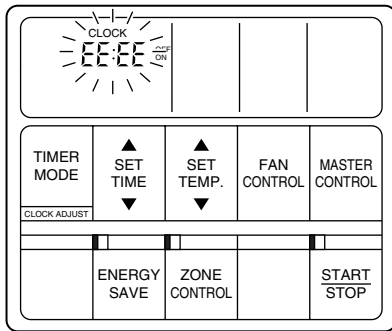

If there is a problem with the air conditioner, it will stop running and "EE: EE" will be displayed instead of the clock.

1. If the operation lamp is on then press the **START/STOP** buttons to turn it off.
2. Press the **ENERGY SAVE** and the **ZONE CONTROL** buttons at the same time for more than three seconds to start the self diagnosis check.
An error code will be displayed in the clock display area.
3. Press the **ENERGY SAVE** and the **ZONE CONTROL** buttons again for more than three seconds to end the self diagnosis check.

Error Code	Error
E0:00	Communication error (indoor unit ↔ remote controller)
E1:00	Communication error (indoor unit ↔ outdoor unit)
E2:00	Room temperature sensor open.
E3:00	Room temperature sensor shorted.
E4:00	Indoor heat exchanger temperature sensor open.
E5:00	Indoor heat exchanger temperature sensor shorted.
E6:00	Outdoor heat exchanger temperature sensor open.
E7:00	Outdoor heat exchanger temperature sensor shorted.
E8:00	Outdoor temperature sensor open.
E6:00	Outdoor temperature sensor shorted.
EC:00	Discharge pipe temperature sensor open.
Ed:00	Discharge pipe temperature sensor shorted.
EE:00	High pressure abnormal.
EF:00	Discharge pipe temperature abnormal.

OPERATING TIPS

Instructions relating to heating(*) are applicable only to "HEAT & COOL MODEL" (Reverse Cycle).

Operation and Performance

*Heating Performance

- This air conditioner uses a heat pump which absorbs heat from outside air and brings it indoors. As a result, its heating performance is reduced as the temperature of outside air drops. If you find that insufficient room heat is produced, we recommend that you use the air conditioner together with other heating appliances.
- Heat-pump type air conditioners use warm-air recirculation to warm your entire room. As a result, some time will be required after starting operation until your entire room becomes warm.

Outdoor Unit Fan Speed Control

- Depending on the outdoor temperature, the outdoor unit automatically stops the fans or adjusts their speed.

*Microcomputer-controlled Automatic Defrosting

- When the outside temperature is low and the humidity high, frost will collect on the outside unit, reducing heater efficiency. When this happens, the computer will automatically start the defrost cycle. During the defrost cycle, the indoor fan will shutdown and **DEFROST** will be displayed on the remote controller. It will take anywhere from 4 to 15 minutes before the air conditioner starts up again.

*When Indoor and Outdoor Temperatures are High

- When both indoor and outdoor temperatures are high during use of the heating mode, the outdoor unit's fan may stop at times.

Temperature and Humidity Range

			Cooling Mode	*Heating Mode
Outdoor temperature	COOLING MODEL	ART60AL	About 0 to 52°C	—
		ART36AL ART45AL	About 21 to 52°C	—
	HEAT & COOL MODEL (Reverse Cycle)	ART60RL	About 0 to 52°C	About -8 to 21°C
		ART36RL ART45RL	About 0 to 52°C	About -5 to 21°C
Indoor temperature			About 18 to 32°C	About 30°C or less
Indoor humidity			About 80% or less If the unit is used for long periods under high-humidity conditions, condensation may form on the surface of the indoor unit, and drip onto the floor or other objects underneath.	—

- If the air conditioner is operated under higher temperature conditions than those listed, the built-in protection circuit may operate to prevent internal circuit damage. Also, during Cooling and Dry modes, if the unit is used under conditions of lower temperatures than those listed above, the heat-exchanger may freeze, leading to water leakage and other damage.
- Do not use this unit for any purposes other than the Cooling, (*)Heating, Dehumidifying, and air-circulation of rooms in ordinary dwellings.

SYSTEM OPERATION

There are different ways the unit can be controlled. (Consult the remote controller operating instructions for details on setting the operating functions).

<Spare Remote Controller>

Two remote controllers can be connected to one air conditioner unit. The air conditioner operation contents are the remote controller setting contents set later. (Both remote controllers show the same display.)

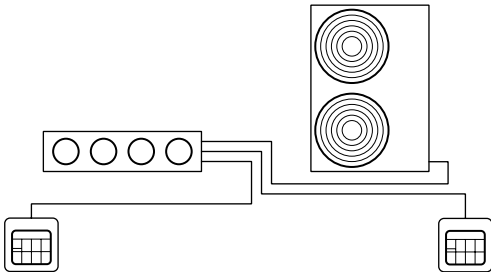

<Control Several Units with just one Remote Controller>

One remote controller can control up to 16 air conditioners. All the air conditioners can be operated with the same setting.

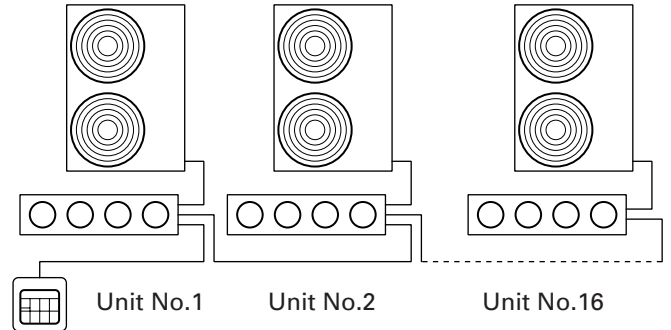

To Use the ZONE CONTROL

When the ZONE CONTROL button is pressed while multiple air conditioners are being centralized controlled, only the preset air conditioners stop.

Press the ZONE CONTROL button.

Preset units will stop.

To Stop the ZONE CONTROL

Press the ZONE CONTROL button one more time.

Those units that were stopped will start again.

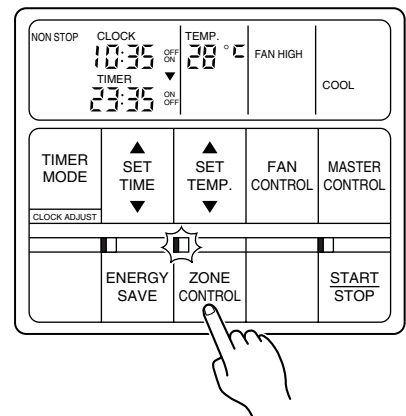

Auto Restart

When the air conditioner power was temporarily turned off by a power failure, etc., it will restart automatically after the power recovers. (Operated by settings before the power failure.)

TROUBLESHOOTING

Instructions relating to heating(*) are applicable only to "HEAT & COOL MODEL" (Reverse Cycle).



DANGER!

In the event of a malfunction (burning smell, etc.), immediately stop operation, turn off the electrical breaker, and consult authorized service personnel.

Always be sure to turn off the electrical breaker to ensure that power is completely off.

Before requesting service, perform the following checks:

	Symptom	Problem	See Page
NORMAL FUNCTION	Doesn't operate immediately:	<ul style="list-style-type: none"> ● If the unit is stopped and then immediately started again, the compressor will not operate for about 3 minutes, in order to prevent fuse blowouts. ● Whenever the power switch is turned off then on again, the protection circuit will operate for about 3 minutes, preventing unit operation during that period. 	—
	Make noise:	<ul style="list-style-type: none"> ● During operation and immediately after stopping the unit, you may hear the sound of water flowing in the air conditioner's piping. Also, noise may be particularly noticeable for about 2 to 3 minutes after starting operation (This is the sound of coolant flowing). ● During operation, you may hear a slight squeaking sound. This is caused by minute expansion and contraction of the front cover resulting from change in temperature. 	—
	Smells:	<ul style="list-style-type: none"> ● Some smell may be emitted from the indoor unit. This smell is the result of room odors. (furniture, tobacco, etc.) which have been taken into the air conditioner. 	—
	Mist or steam are emitted:	<ul style="list-style-type: none"> ● During the Cooling operation, a thin mist may be seen emitted from the indoor unit. This is a result of sudden cooling of room air by the air emitted from the air conditioner, resulting in condensation and misting. *● During Heating operation, the outdoor unit's fan may stop, and steam may be seen rising from the unit. This is due to operation of the defrosting mode. 	—
CHECK ONCE MORE	Doesn't operate at all:	<ul style="list-style-type: none"> ● Has there been a power failure? ● Has a fuse blown out, or a circuit breaker been tripped? ● Is the main power switch set to the OFF position? ● Is the timer operating? 	8
	Poor Cooling (or *Heating) performance:	<ul style="list-style-type: none"> ● Is the air filter dirty? ● Are the air conditioner's intake grille or outlet vents blocked? ● Did you adjust the room temperature settings (thermostat) correctly? ● Is there a window or door open? ● During the cooling operation, is a window allowing bright sunlight to enter? (Close the curtains.) ● During the cooling operation, is there a heat source operating inside the room, or are there too many people in the room? 	—