

MODEL: CARRIER-KJR-120C/TF-H-01



WIRED CONTROLLER MANUAL



Thank you very much for purchasing our air conditioner,
Before using your air conditioner, please read this manual carefully and keep it for future reference.



- This manual gives detailed description of the precautions that should be brought to your attention during operation.
- In order to ensure correct service of the wired controller please read this manual carefully before using the unit.
- For convenience of future reference, keep this manual after reading it.

CONTENTS

1. SAFETY PRECAUTIONS.....	1
2. INSTALLATION ACCESSORY.....	2
3. INSTALLATION METHOD.....	4
4. WIRING DIAGRAM BETWEEN WIRE CONTROLLER AND AIR CONDITIONER.....	7
5. SPECIFICATION.....	8
6. NAME ON THE LCD OF THE WIRE CONTROLLER.....	9
7. NAME OF BUTTON ON THE WIRE CONTROLLER.....	10
8. PREPARATORY OPERATION.....	12
9. OPERATION.....	13
10. TIMER FUNCTIONS.....	18
11. WEEKLY TIMER.....	21
12. FAULT ALARM HANDING.....	28
13. TECHNICAL INDICATION AND REQUIREMENT	28

1. SAFETY PRECAUTIONS

- Read the safety precautions carefully before installing the unit.
- Stated below are important safety issues that must be obeyed.

 WARNING	Means improper handling may lead to personal death or severe injury.
 CAUTION	Means improper handling may lead to personal injury or property loss.



WARNING

Please entrust the distributor or professionals to install the unit.
Installation by other persons may lead to imperfect installation, electric shock or fire.
Adhere to this installation manual.
Improper installation may lead to electric shock or fire.
Reinstallation must be performed by professionals.
Improper installation may lead to electric shock or fire.

Do not uninstall the unit randomly.
Random uninstalling may lead to abnormal operation, heating or fire of the air condition.



NOTE

- ① Do not install the unit in a place vulnerable to leakage of flammable gases. Once flammable gases are leaked and left around the wire controller, fire may occur.
 - ② Do not operate with wet hands or let water enter the wire controller. Otherwise, electric shock may occur.
 - ③ The wiring should adapt to the wire controller current. Otherwise, electric leakage or heating may occur and result in fire.
 - ④ The specified cables shall be applied in the wiring. No external force may be applied to the terminal. Otherwise, wire cut and heating may occur and result in fire.
-

2. INSTALLATION ACCESSORY

Select the installation location

Don't install at the place where cover with heavy oil, vapor or sulfureted gas, otherwise, this product would be deformed that would lead to system malfunction.

Preparation before installation

1. Please confirm that all the following parts you have been supply.

No.	Name	Qty.	Remark
1	Wire controller	1	_____
2	Battery	1	_____
3	Cruciform slot screw M4×25	2	This accessory is used when install the wire controller inside the electric cabinet
4	Plastic bolt	2	
5	Installation and owner's manual	1	_____
6	The connective wires group(on some models)	1	_____

2. Please filed install the following accessory.

No.	Name	Qty.	Remark
1	Electric cabinet	1	Universal electric cabinet's specification. Pre-embed it into wall.
2	Wire configured tube (insulated sheath)	1	Pre-embed into wall, the longest length should not exceeding than 15m.
3	Phillips screwdriver	1	For install Cruciform slot screw.
4	Slotted head screwdriver	1	For unscrew the bottom cover of wire controller.

2. INSTALLATION ACCESSORY

Precaution of install the wire controller

1. This manual provides the installation method of wire controller. Please refer to the wiring diagram of this installation manual to wire the wire controller with indoor unit.
2. The wire controller working in low voltage loop circuit. Forbid to directly contact the cable of 220V commercial electricity or of 380V high voltage, and don't wire this kind of wire in the said loop; wiring clearance between configured tubes should at the range of 300~500 or above.
3. The Shielded wire of the wire controller must be grounded reliable.
4. Upon finish the wire controller connection, do not employed tramegger to detect the insulation.
5. The connective cable of wire controller should not be longer than 20 meters.

3. INSTALLATION METHOD

Installation diagram

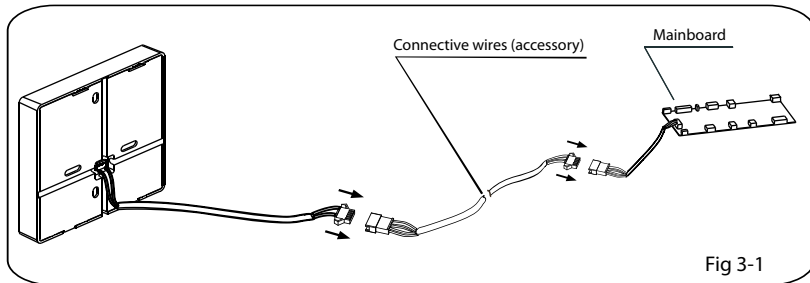

1. Connect the female joint of wires group from the mainboard with the male joint of connective wires group. (See Fig.3-1)
2. Please connect the other side of connective wires group with the male joint of wires group leads from wire controller. (See Fig.3-1)

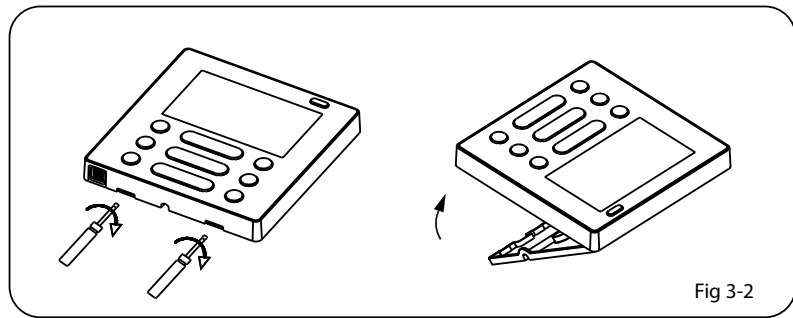

3. Take off the cover of wire controller at the bottom with the screwdriver. (See Fig.3-2)

3. INSTALLATION METHOD

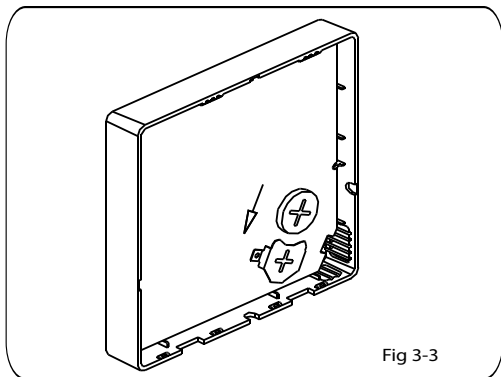

4. Put the battery into the installation site and make sure the positive side of the battery is in accordance with the positive side of installation site. (See Fig.3-3)

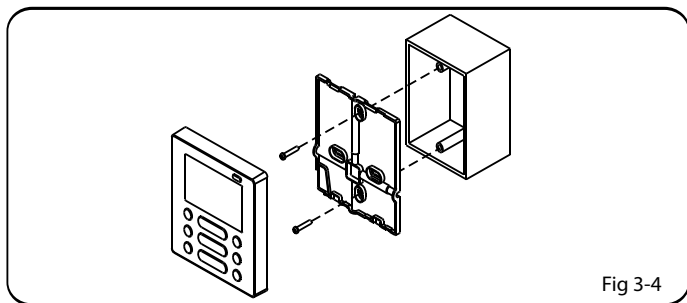

3. INSTALLATION METHOD

5. Adjust the length of two plastic bolts base on the length of through out from standard electric cabinet to the wall. Confirm the two bolts fixing in the cabinet are in the same length and vertical to the wall surface.
6. Fix the bottom cover to the electric cabinet by the accessory slotted head screws. Confirm the bottom cover is parallel to wall surface. And then reinstall the bottom cover to centralized controller. (See fig 3-4)



NOTE

Over tighten the screw would cause rear cover deformed and LCD damage.

When installation, please maintain the screws and wire controller at the same height level without deformed.

When installation, please reserve a certain length of wire controller connective cable for future maintenance to take off the wire controller.

4 . WIRING DIAGRAM BETWEEN WIRE CONTROLLER AND AIR CONDITIONER

1. Wiring diagram of wire controller connects with indoor unit (See fig 4-1)

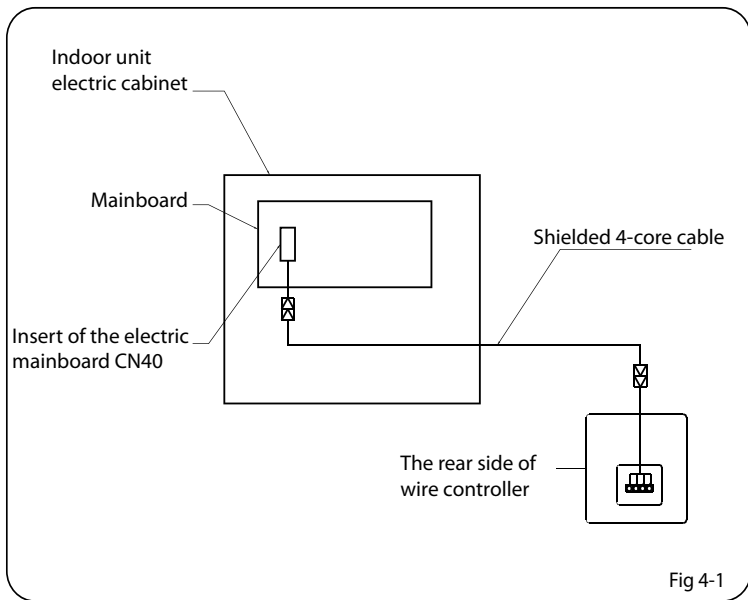

5. SPECIFICATION

Input voltage	DC 5V/DC 12V
Ambient temperature	-5~43°C (23~110°F)
Ambient humidity	RH40%~RH90%

All the pictures in this manual are for explanation purpose only.
Your wire controller may be slightly different .The actual shape
shall prevail.

6. NAME ON THE LCD OF THE WIRE CONTROLLER

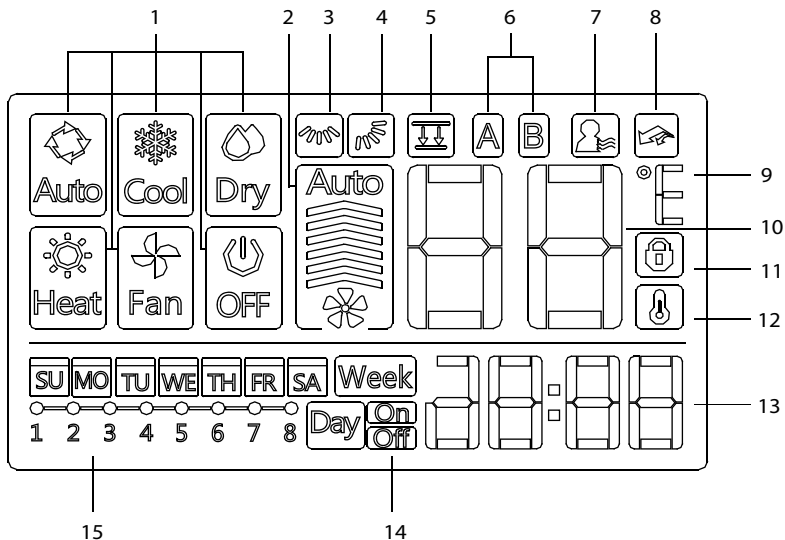

- | | |
|---|--------------------------------|
| 1 Operation mode indication | 8 PTC function indication |
| 2 Fan speed indication | 9 C° / F° indication |
| 3 Left-right swing indication | 10 Temperature display |
| 4 Up-down swing indication | 11 Lock indication |
| 5 Faceplate function indication | 12 Room temperature indication |
| 6 Main unit and secondary unit indication | 13 Clock display |
| 7 Follow me function indication | 14 On/Off timer |
| | 15 Timer display |

7. NAME OF THE BUTTON ON THE WIRE CONTROLLER

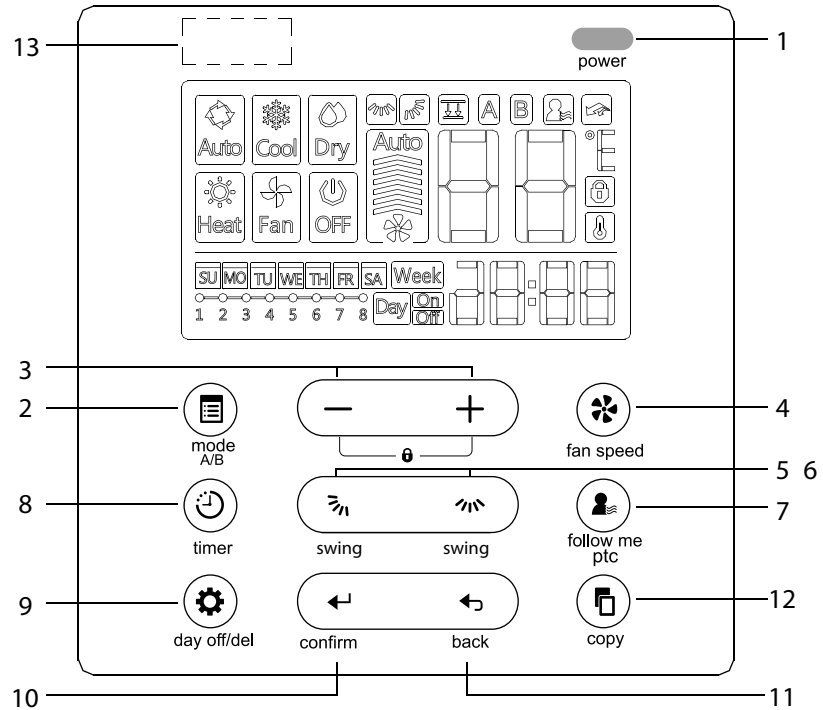



7. NAME OF THE BUTTON ON THE WIRE CONTROLLER

- 1 Power Button
- 2 Mode(A/B) Button
- 3 Adjust Button
- 4 Fan speed Button
- 5 Up-down Airflow Direction and Swing Button
- 6 Left-right Airflow Swing Button
- 7 Follow me(PTC) Button
- 8 Timer Button
- 9 Day off(Del) Button
- 10 Confirm Button
- 11 Back Button
- 12 Copy Button
- 13 Infrared remote receiver (on some models)

8. PREPARATORY OPERATION

Set the current day and time

- 1  timer Press the Timer button for 3 seconds or more.
The timer display will flash.
-

- 2  Press the button "+" or "-" to set the date. The selected date will flash.
- 
- The diagram shows a sequence of seven boxes representing days of the week: SU, MO, TU, WE, TH, FR, SA. Each box is connected to the next by a right-pointing arrow. A line connects the SA box back to the SU box, forming a loop. The MO box is highlighted with a thick border, indicating it is the selected day.
-

- 3  timer The date setting is finished and the time setting is prepared after pressing Timer button or there is no pressing button in 10 seconds.
-

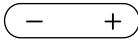
- 4  Press the button "+" or "-" to set the current time.
Press repeatedly to adjust the current time in 1-minute increments.
Press and hold to adjust the current time continuous.



ex. Monday AM 11:20

- 5  timer The setting is done after pressing Timer button or there is no pressing button in 10 seconds.

9. OPERATION

To start/stop operation



Press the Power button.

Operation lamp
Air conditioner ON :Lit brightly
Air conditioner OFF:Not lit

To set the operation mode

Operation mode setting



Press the Mode button to set the operation mode.
(Heat function is invalid for cool only type unit)

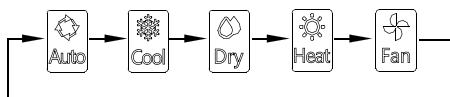

Room temperature setting

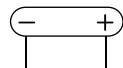

Lower Rise

Press the button " + " or " - " to set the room temperature.
Indoor Setting Temperature Range : 17~30°C (62~86°F)

9. OPERATION

Fan speed setting



Press the Fan speed button to set the fan speed.
(This button is unavailable when in the mode of Auto or Dry)

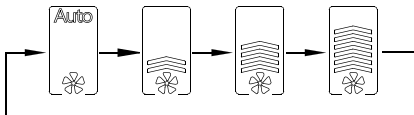

Room temperature sensor selection

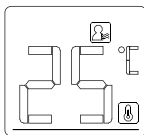
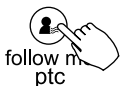

Press the Follow me/PTC button to select whether the room temperature is detected at the indoor unit or the wire controller.

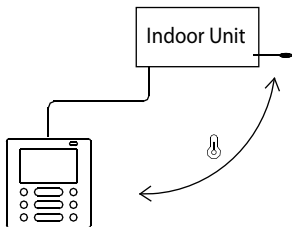

When the Follow me function indication  appears, the room temperature is detected at the wire controller.

9. OPERATION

PTC function (on some models)



Press the Follow me/PTC button for 2 seconds or more to activate the PTC function, when the unit is under the Heat mode.

Press the buttons again for 2 seconds or more to deactivate the PTC function.

When the PTC function is activated, the  mark appears.

Child lock function

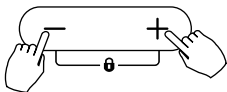

Press and hold "+" and "-" buttons together for 3 seconds or more to activate the child lock function and lock all buttons on the wire controller.

Press the buttons again for 3 seconds or more to deactivate the child lock function.

When the child lock function is activated, the  mark appears.

°C & °F scale selection (on some models)

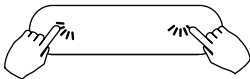

Press and hold °C and °F buttons together for 3 seconds will alternate the temperature display between the °C & °F scale.

9. OPERATION

Faceplate function (on some models)



1. When the unit is off, Press the Mode(A/B) button long to activate the faceplate function. The  mark will flash.

The F2 mark appears when the faceplate is adjusted.

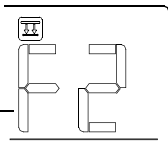

2. Push the Mode(A/B) button to select Unit A or Unit B, the wire controller select in a sequence that goes from (this step do not need to perform if the wire controller is connected with one unit only):

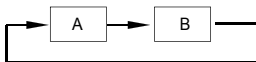

3. Press the button "+" and "-" to control the lift and drop of the faceplate.
Pressing the "+" button can stop the faceplate, while it is dropping.
Pressing the "-" button can stop the faceplate, while it is lifting.

Left-right airflow swing (on some models)



Press the  button to activate the auto Left-right swing feature of the louver. And then the louver would swing automatically. Press it again to stop.

When the auto Left-right swing feature of the louver is activated, the  mark appears.

9. OPERATION

Up-Down airflow direction and swing (on some models)

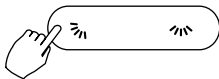

Use the button to adjust the Up-down airflow direction.

1. When press the button once and quickly, the Up-down airflow direction setting feature of the louver is activated. The moving angle of the louver is 6° for each press. Keep pressing the button to move the louver to the desired position.
2. If press the button long, the auto Up-down swing feature of the louver is activated. The louver would swing automatically. Press it again to stop.

When the auto Up-down swing feature of the louver is activated, the  mark appears.

- The operation can refer to the following instructions for the unit with four Up-down louvers can be operated individually.

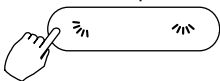

1. Press the button to activate the Up-down adjusting louver function.

The  mark will flash.

2. Push the Mode(A/B) button to select Unit A or Unit B, the wire controller select in a sequence that goes from (this step do not need to perform if the wire controller is connected with one unit only):

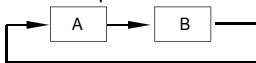

3. Pressing the button "+" and "-" can select the movement of four louvers. Each time you push the button, the wire controller select in a sequence that goes from: (the icon  means the four louvers move at the same time.)

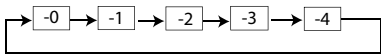

4. And then use the button to adjust the Up-down airflow direction of the selected louver.

10. TIMER FUNCTIONS



WEEKLY timer

Use this timer function to set operating times for each day of the week.



On timer

Use this timer function to start air conditioner operation. The timer operates and air conditioner operation starts after the time has passed.



Off timer

Use this timer function to stop air conditioner operation. The timer operates and air conditioner operation stops after the time has passed.



On and Off timer

Use this timer function to start and stop air conditioner operation. The timer operates and air conditioner operation starts and stops after the time has passed.

10. TIMER FUNCTIONS

To set the On or Off TIMER

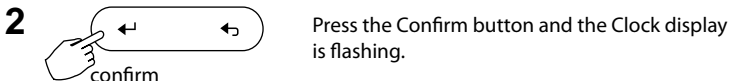
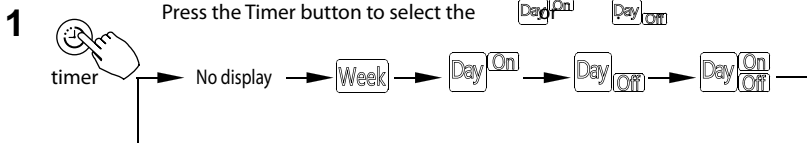

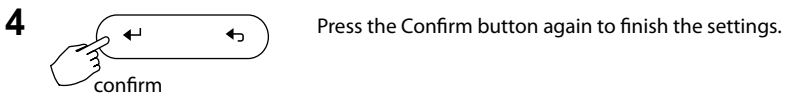

Press the button “+” or “-” to set the time. After the time is set, the timer will start or stop automatically.



10. TIMER FUNCTIONS

To set the On and Off TIMER

1  Press the Timer button to select the timer 

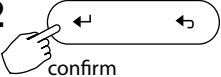
2  Press the Confirm button and the Clock display is flashing.

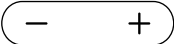
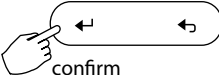
3  

Press the button "+" or "-" to set the time of On timer, and then press the Confirm button to confirm the setting.

4  Press the button "+" or "-" to set the time of Off timer.

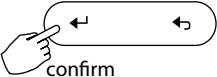
5  Press the Confirm button to finish the settings.

11. WEEKLY TIMER

1 Weekly timer setting

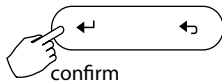

Press the Timer button to select the **Week**, and then press the Confirm button to confirm.

2 Day of the week setting

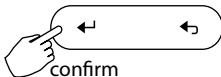

Press the button "+" and "-" to select the day of the week, and then press the CONFIRM button to confirm the setting.



3 Time scale setting

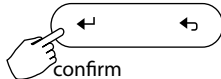

Press the button "+" and "-" to select the setting time. The setting time, mode, temperature and fan speed will be shown on the LCD. Press the Confirm button to enter the setting-time process.

11. WEEKLY TIMER

Up to 8 time scales can be set in one day. Mode, temperature and fan speed in different time scale can be set.

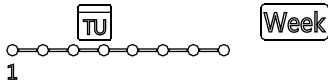

ex. Tuesday time scale 1

4 Time setting

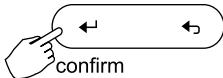

Press the button " + " and " - " to set the time. and then press the Confirm button to confirm the setting.

5 Operation mode setting

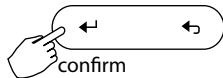
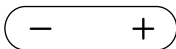

Press the button " + " and " - " to set the operation mode. and then press the Confirm button to confirm the setting.

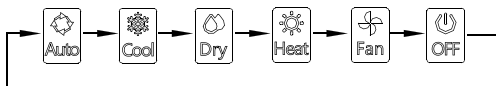

6 Room temperature setting

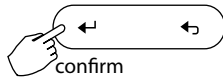

11. WEEKLY TIMER

Press the button “+” and “-” to set the room temperature .and then press the Confirm button to confirm the setting.

NOTE:This setting is unavailable when in the mode of Fan or Off.

7 Fan speed setting

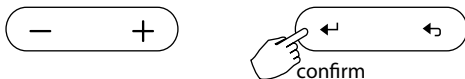

Press the button “+” and “-” to set the fan speed .and then press the Confirm button to confirm the setting.

NOTE: This setting is unavailable when in the mode of Auto, Dry or Off

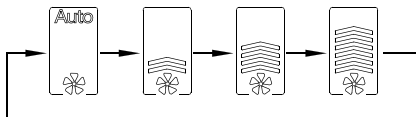

8 Different time scales can be setted by repeating step 3 to 7.

9 Other days in one week can be setted by repeating step 3 to 8.

NOTE: ☒ The weekly timer setting can be returned to the previous step by pressing Back button.

☒ The current setting will be restored and withdrawn the weekly timer setting automatically when there is no operation for 30 seconds.

11. WEEKLY TIMER

WEEKLY timer operation

☑ To start



Press the Timer button to select the timer mode. The timer starts automatically.

Week

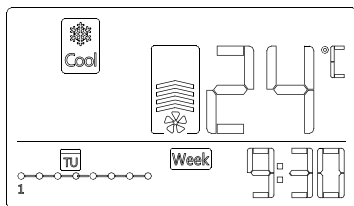

ex.

☑ To cancel



Press the Power button to cancel the timer mode.



The timer mode can also be canceled by changing the timer mode using the Timer button.

To set the DAY OFF (for a holiday)

1



During the weekly timer, press the Confirm button to set the day.

2

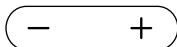

Press the button "+" and "-" to select the day to set the DAY OFF.

11. WEEKLY TIMER



Press the Day off button to set the DAY OFF.



ex. The DAY OFF is set for Wednesday

4 The DAY OFF can be set for other days by repeating the steps 2 and 3.

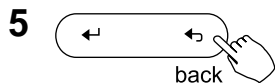

Press the Back button to back to the weekly timer.

☒ To cancel: Follow the same procedures as those for setup.

☒ Notes:

The DAY OFF setting is cancelled automatically after the set day has passed.

Copy out the setting in one day into the other day.

☒ A reservation made once can be copied to another day of the week.

The whole reservation of the selected day of the week will be copied.

The effective use of the copy mode ensures ease of making reservations.

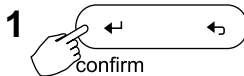

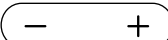

During the weekly timer, press the Confirm button.

2  Press the button " + " and " - " to select the day to copy from.

11. WEEKLY TIMER

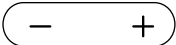
- 3**  Press the Copy button, the letter "CY" will be shown on the LCD.

- 4**  Press the button "+" and "-" to select the day to copy to.

- 5**  Press the Copy button to confirm .

The  mark flashes quickly

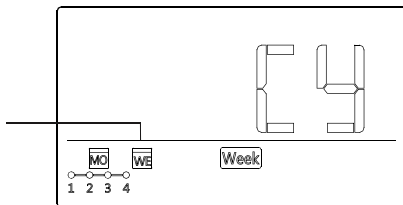

ex. Copy the setting of Monday to Wednesday

- 6** Other days can be copied by repeating step 4 and 5.

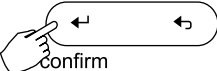
- 7**  Press the Confirm button to confirm the settings.

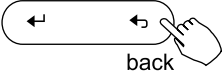
- 8**  Press the Back button to back to the weekly timer.

11. WEEKLY TIMER

Delete the time scale in one day.

1



During the weekly timer, press the Confirm button.

2

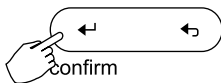

Press the button "+" and "-" to select the day of the week and then press the Confirm button to confirm the setting.

3



Press the button "+" and "-" to select the setting time want to be deleted. The setting time, mode, temperature and fan speed will be shown on the LCD. The setting time, mode, temperature and fan speed can be deleted by pressing the Day off (Del) button.

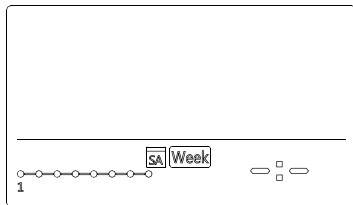
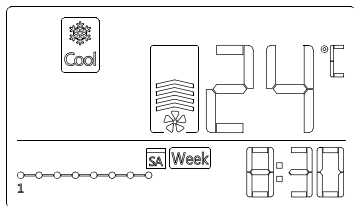

ex. Delete the time scale 1 in saturday

12. FAULT ALARM HANDING

If the system does not properly operate except the above mentioned cases or the above mentioned malfunctions is evident, investigate the system according to the following procedures.

NO.	MALFUNCTION & PROTECTION DEFINE	DISPLAY DIGITAL TUBE
1	Error of communication between wire controler and indoor unit	F0
2	The faceplate is abnormal	F1

Please check the error display of indoor unit and read <<OWNER'S MANUAL>> if other error code appears.

13. TECHNICAL INDICATION AND REQUIREMENT

EMC and EMI comply with the CE certification requirements.



turn to the experts™

