

Mitsubishi Electric Air-conditioner Network System

Central Controller Model: G-50A

Instruction Book

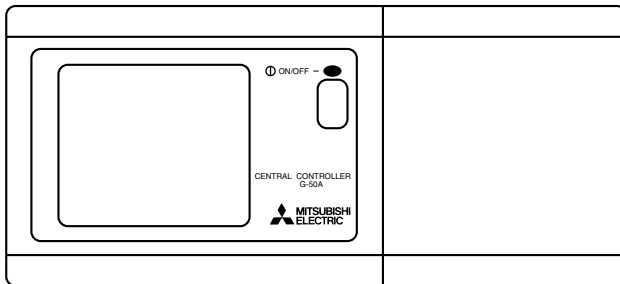

Contents



1. Safety precautions	1
2. Product features	2
3. Functions	4
3-1 Specifications	4
3-2 Display Screen	8
4. User operation	10
4-1 Operation condition monitor	11
4-2 Operation setting	12
4-2-1 Group operation setting	12
4-2-2 Collective operation setting	16
4-3 Timer operation	19
4-4 Malfunction	23
4-5 Current time setting	24
5. Initial setting	25
5-1 Shifting to initial setting menu	25
5-2 M-NET address setting	25
5-3 Function setting	26
5-4 Group configuration setting	27
5-5 Interlocked operation setting	29
5-6 Group name setting	31
5-7 User setting	34
5-8 IP address setting	35
5-9 Initial setting tools connection function	35
6. Maintenance	36
6-1 Refrigerant system monitor	36
6-2 Malfunction log monitor	37
7. External input / output function	38
7-1 External input function	38
7-2 External output function	39
Appendix 1: Initial setting (abridged)	40
Appendix 2: User operation (abridged)	42

Before using the controller, please read this Instruction Book carefully to ensure proper operation. Keep this manual for future reference.

1. Safety precautions

Before using the controller, read the Safety Precautions section carefully to ensure proper operation. These safety precautions must be observed by anyone who operates the central controller at all times. Keep this Instruction Book and Installation Manual for future reference. Make sure both this Instruction Book and the Installation Manual are given to the next user.

Safety symbols used in this manual

 WARNING	This symbol indicates that failure to follow the instructions exactly as stated poses the risk of serious injury or death.
 CAUTION	This symbol indicates that failure to follow the instructions exactly as stated poses the risk of injury or damage to the controller.

 WARNING	
<ul style="list-style-type: none"> ● Have the unit professionally installed. Improper installation by an unqualified person may result in a risk of electric shock or fire. ● Make sure the controller is securely mounted so that it will not fall. ● Make sure that the controller is connected to a properly rated power supply to avoid fire or damage to the controller. ● Do not remove the cover during operation. Contact with electrically charged parts on the controller cause skin burns or other types of injury. ● If any abnormality is noticed (e.g., burning smell), stop the operation, turn off the power supply, and contact your dealer or technical representative immediately. Continuing the operation may result in damage to the controller, electric shock, or fire. 	<ul style="list-style-type: none"> ● Ask your dealer or an authorized technician to move the controller. Improper installation may result in electric shock or fire or damage to the controller. ● Controllers must be disposed of properly. Contact your dealer for proper disposal procedures. ● Do not attempt to modify or repair the controller. Modification or improper repair may result in electric shock or fire. Consult your dealer when repairs are necessary. ● Stop the operation immediately and notify your dealer if an error code is displayed and the controller does not operate, or when any abnormality is noticed. Continuing the operation may result in damage to the controller or fire.

 CAUTION	
<ul style="list-style-type: none"> ● Do not install the controller where there is a risk of leakage of flammable gas. If the leaked gas accumulates around the controller, it may be ignited and result in an explosion. ● Do not wet the controller. Water may damage the controller and cause an electric shock. ● To avoid the risk of electric shock or damage to the controller, do not touch the switches with wet hands. ● Do not use the controller for specialized applications. This product is designed exclusively for use with the MITSUBISHI ELECTRIC building air conditioning control system. The use of this product with other air-conditioning management systems or for other purposes may result in malfunctions. ● Do not spray insect sprays or sprays with flammable propellants to the controller. To avoid the risk of fire or explosion, do not place flammable sprays near the controller or spray them directly on the controller. 	<ul style="list-style-type: none"> ● Do not use the controller in an environment high in oil, steam, or sulfuric gas. These substances may have adverse effects on the performance of the controller or damage its parts. ● To avoid the risk of electric shock or damage to the controller, do not press the switches with sharp objects. ● Operate the controller within the temperature range specification. The use of controller outside of its specification may result in serious damage to the controller. Be sure to check the temperature range specification in the Instruction Book.

2. Product features

The central controller is capable of controlling up to 50*1 air conditioner units. It supports the following functions.
(*1: The maximum number of connectible units depends on the indoor unit models.)

[1] User operation functions

(1) Operation

1. Most of the functions of the local remote controllers are supported by the central controller.
The central controller can turn on or off the indoor units in specific groups, display the room temperature for each indoor unit group, change the operation mode of the indoor units (COOL, DRY, FAN, AUTO and HEAT) and of the ventilation units (HEAT RECOVERY, BY-PASS, AUTO) as well as change the fan speed, air flow direction (4 directions and swing), ventilation mode (OFF, LOW speed, or HIGH speed), TIMER MODE, and temperature setting.
(Refer to section "5-7 User setting".)
2. Access to specific functions of the local remote controller, such as ON/OFF operation, mode selection, temperature setting, and filter sign reset can be prohibited.
3. Group setting
Operation settings can be made for the entire groups or for each individual group.

(2) Weekly Schedule

1. The weekly schedule allows four different patterns of schedule to be set for each group. (P1-P4)
Three of the four patterns (P1, P2, P3) are used to set the ON/OFF schedule, and the other one (P4) is used to prohibit the operation from the local remote controller. The ON/OFF schedule patterns (P1, P2, P3) can be used in combination with the operation prohibition function (P4) to set the schedule within the same day. By setting the schedule for each day of the week by using the four schedule patterns in combination, a weekly setting can be made for each group.
2. For each day, three ON times and three OFF times, or three prohibition times and three permission times can be set. It is possible to set only the ON times (prohibition times only) or only the OFF times (permission times only).
3. Easy setting
Daily operation schedule and weekly schedules (P1-P4) of a group can be copied to the settings for other groups.

(3) Operation status monitoring

1. The ON, OFF, or MALFUNCTION status of each unit or the group can be monitored.
2. Either the group numbers or the first three characters of group names that are controlled by the central controller can be displayed. The address of all units can be displayed altogether.
3. While all groups are displayed on the screen, the group that is marked with the ▷ symbol can be turned ON or OFF.

(4) Malfunction monitoring

1. The unit in error, error code, the address of the unit that detected the unit in error will appear on the "Malfunction monitor" screen.
2. Pressing the reset key stops all the units in the same group or in the same refrigerant system as the unit in error, and resets the error.

[2] System configuration setup and maintenance

(1) System configuration setup

1. Indoor units, local remote controllers, and lower-level system remote controllers can be registered in the same group. OA processing or LOSSNAY units can also be registered.

2. Each group can be specified by its name.
(Alphanumerical characters can be used for the group name.)
3. Group names can be copied to the settings for the other groups.
4. The group configuration settings and the group names can be set as long as power is supplied to the central controller, even if indoor units have not been connected.
5. When the system configuration was changed, the system configuration data on the central controller can be erased all at once if necessary.

(2) Refrigerant system monitoring

The addresses of all the units (indoor, outdoor, etc.) in each refrigerant system can be displayed on this screen. This information is useful for checking the address setting, transmission line connection, and power supply connection.

(3) Interlocked operation setting

Make this setting to perform an interlocked operation of one or more of the indoor units and a ventilation unit. The interlocked ventilation unit will go into operation when one of the indoor units that is interlocked with it goes into operation.

(4) Malfunction log

1. The log of the central controller will be kept for the last 64 errors.
2. Information about the date/time of error occurrence, address of the error-source unit, error code, and the address of the unit that detected the error will be displayed on the screen.
3. The log of the central controller and indoor units can be deleted all at once with the reset button.

[3] Miscellaneous

(1) Entire-system status lamp (Operation/Stop)

Displays the status of the entire system (Normal operation, all OFF, and malfunction status are indicated with a lit, unlit, blinking lamp respectively).

(2) Collective ON/OFF switch

This switch turns all of the units in the system ON or OFF at once.

(3) Power supply wiring

Power to the central controller is supplied from the PAC-SC50KUA unit through the M-NET transmission line of DC power line. The length of the DC power line between the PAC-SC50KUA power supply unit and the central controller must not exceed 10 m.

The central controller can be connected to anywhere on the M-NET transmission line. (M-NET transmission line is a central control line that is connected to the TB7 on the outdoor unit.)

3. Functions

3 - 1 Specifications

Item		Specification	
Source power requirement	Input voltage	DC24V, 0.02A (Maximum loading) Power received from PAC-SC50KUA Power Supply Unit via M-NET transmission line, or from an R410A compatible CITY MULTI outdoor unit (except the S Series). *Note: While the power to the connected outdoor unit is turned off, the G-50A cannot perform a schedule operation, collect charge data, or perform energy save control.	
		DC12V, 0.2A (Maximum loading) Power is received from the PAC-SC50KUA Power Supply Unit via the DC power line.	
Environmental condition	Temperature	Operating 0°C ~ +40°C / 32°F ~ +104°F Non operating - 20°C ~ +60°C / - 4°F ~ +140°F	
	Humidity	30 ~ 90%RH (No condensation)	
Dimensions	mm	120 (H) × 300 (W) × 80 [*19] (D)	*[*]: indicate the thickness from the wall.
	in	4-3/4 (H) × 11-13/16 (W) × 3-1/8 [*3/4] (D)	
Weight	kg	1.0	
	lb	2-1/4	
System condition			
Number of control unit	Indoor unit or independent OA processing unit or LOSSNAY : 50 units maximum (50 groups maximum)*3 Number of units (indoor or independent OA processing unit or LOSSNAY) in one group : 1-16 units *Note Indoor unit, independent OA processing unit and LOSSNAY can not register to the same group.		
	Number of remote controllers in one group : 1-2 Number of system controllers in one group : 0-4 (including the number of remote controller in one group) : 0-3 for groups which have one remote controller. Number of indoor units interlocked with one OA processing unit or LOSSNAY : 0-16 (some types of OA processing unit can only be operated when interlocked to a maximum of 9 units)		
User operating function			
Operation	ON/OFF	The ON/OFF operation can be performed as a collective or per group.	
	Operation mode *1	The switch operation for the operation mode setting can be performed as a collective or per group. [Selectable operation mode for the indoor unit] COOL/DRY/FAN/AUTO/HEAT [Selectable operation mode for the independent ventilation] HEAT RECOVERY/BY-PASS/AUTO	
	Fan speed *1	The switch operation to set the High and Low speed can be performed as a collective or per group. (The 4 fan speed setting is available to the indoor that has 4 levels) (Fan speed is settable to AUTO on the indoor units that support that setting via G-50A of ver. 3.10 or later.)	
	Air direction and swing operation *1	The air flow direction can be switched to 4 directions and swing operation as a collective or per group. (Airflow setting can be switched to "5 directions" or to "AUTO" on the indoor units that support those settings via G-50A of ver. 3.10 or later.)	
	Temperature setting	Temperature setting can be performed collectively or per group. [Setting temperature range] Cool (Dry) operation : 19 ~ 30°C / 67 ~ 87°F Heat operation : 17 ~ 28°C / 63 ~ 83°F Auto operation : 19 ~ 28°C / 67 ~ 83°F	

Item		Specification
Operation	Prohibit local remote control	The specific functions of a local remote controller can be prohibited as a collective or per group. [Prohibit function] ON/OFF operation, Operation mode setting, Temperature setting and Filter sign reset operation.
	Timer operation	The set schedule operations can be switched to ON/OFF (local remote controller operation prohibition/permission) for each group.
	Filter sign reset	The filter sign reset operation after the air filters are cleaned can be performed as a collective or per group.
	Ventilation operation *1	The ventilation operation of the interlocked OA processing unit or LOSSNAY can be collective or per group. [Ventilation operation] Low speed/High speed/Ventilation OFF
Monitor	Collective operation	The overall status lamp displays conditions of the collective statuses.
	Each group operation	Each group operation is displayed on the operation setting screen (group) or operation monitor screen.
	Operation mode	Displayed on the operation setting screen (group).
	Fan speed	
	Air direction	
	Temperature setting	
	Timer operation	
	Filter sign	
	Local remote control prohibition	
	Ventilation operation	
	Room temperature display	
	Central control prohibition	
	External input signal condition	
Malfunction	The unit address and error code are displayed on the malfunction monitor screen when a malfunction occurs.	
Other	Current time back-up	When the power is cut off, the current time is backed up for approximately one week. (When the controller is fully charged. The controller is fully charged by twenty-four hours after power feed.)
	Timer setting	<p>Operation pattern setting can be performed.</p> <ul style="list-style-type: none"> • Operation interval: Minimum 10 minutes • The daily operation pattern and weekly schedule for each group can be set. • A pattern of one day: P1/P2/P3/ P1 / P2 / P3 / P4 / - <ul style="list-style-type: none"> * ON/OFF setting up to three times a day are possible for P1/P2/P3. * P4 enables to set operation prohibition of 3 times per day for the remote controller. * P1 / P2 / P3 implement the schedule which has combined P1/P2/P3 of ON/OFF pattern and P4 of remote controller operation prohibition pattern together. (P1 = P1 + P4 / P2 = P2 + P4 / P3 = P3 + P4 is displayed.) * - is a day without timer operation. • "The reference temperature and set-back value" or "Setting temperature" which are linked with timer operation can be set.

Item		Specification
Other	Group name designation	Group name can be specified and display on the operation setting screen. * Group name setting is need at the initial setting.
	External signal input interface	Emergency stop/normal, ON/OFF, prohibit/permit for local remote operation can be controlled for units being controlled with a non-voltage contact signal input from an external source.
	External signal output interface	When one or more units being controlled are operating, the "ON" signal will be output, and if a malfunction occurs in one or more units, the "malfunction" signal will be output.
Initial setting (for installation and maintenance)		
Connecting information setting	Group setting	The group setting operation for units (indoor units local remote controllers, independent OA processing unit, LOSSNAY and sub system controllers) are performed on the group setting screen.
	Interlocked setting	The interlocked setting for the ventilation equipment as the OA processing unit or LOSSNAY, etc to indoor unit is performed on the interlocked setting screen.
Monitor	Malfunction history	A maximum of the 64 most recent malfunction are displayed on the malfunction log monitor.
	Refrigerant system monitor	The connected unit address are displayed on the refrigerant monitor screen.
Other	User setting	Some of the indication and function that appear on the each screen can be specified to match the needs of the user.
	Main system controller/ Sub system controller setting *2	Main/Sub setting of the system controller. * G-50A does not support sub controllers.
	Prohibition setting enable /disable	The setting of a system controller which the local remote control is prohibition enable or disable.
	The prohibited controller range setting	Selecting of the prohibited controller which is only local remote controller or both local remote controller and the other system controller.
	K-control type	The system composed of K-control type air conditioner equipment can be controlled using the K transmission converter (PAC-SC25KAA).

*1 Each operation is available in accordance with the function of unit.

*2 Main system controller and sub system controller.

* G-50A does not support sub controllers.

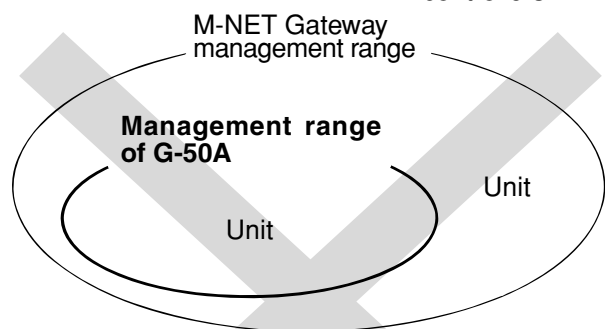
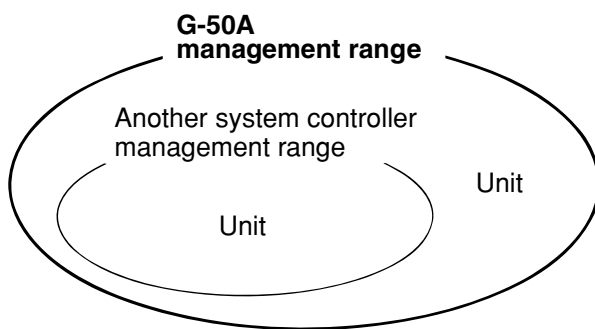

When G-50A controls another system controller or when the system contains only G-50A:

G-50A is set as the main system controller.

* G-50A performs the group setting in this configuration.

When G-50A is controlled by another system controller: (Example: MJ-300Gateway)

G-50A is set as the sub system controller.

* The group setting is performed by main system controller.

*3 The number of connectible units may be fewer depending on the indoor unit models.

NOTE:

The following group setting cannot be performed.

- Unit groups which are not under the management of the main controller and are managed by the sub system controller.

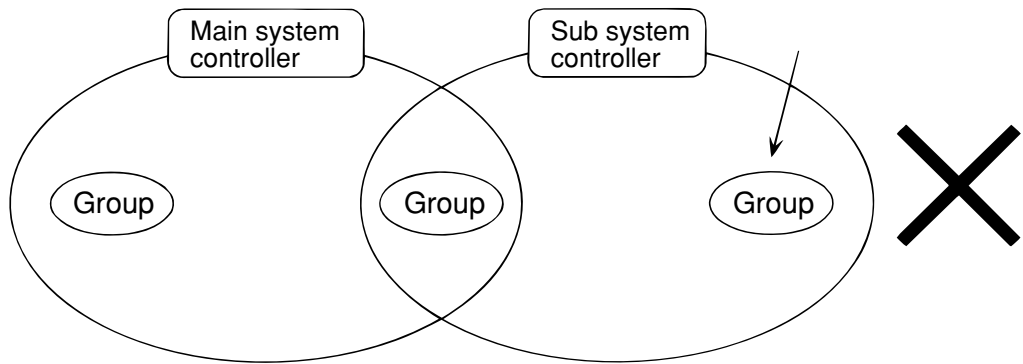

- A common group is managed by more than two main controllers.

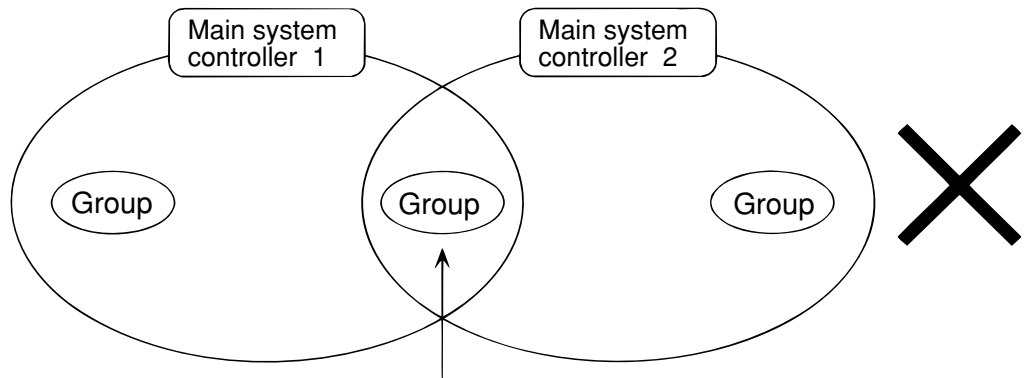

- A sub system controller which exceeds the management range of the main system controller of two or more.

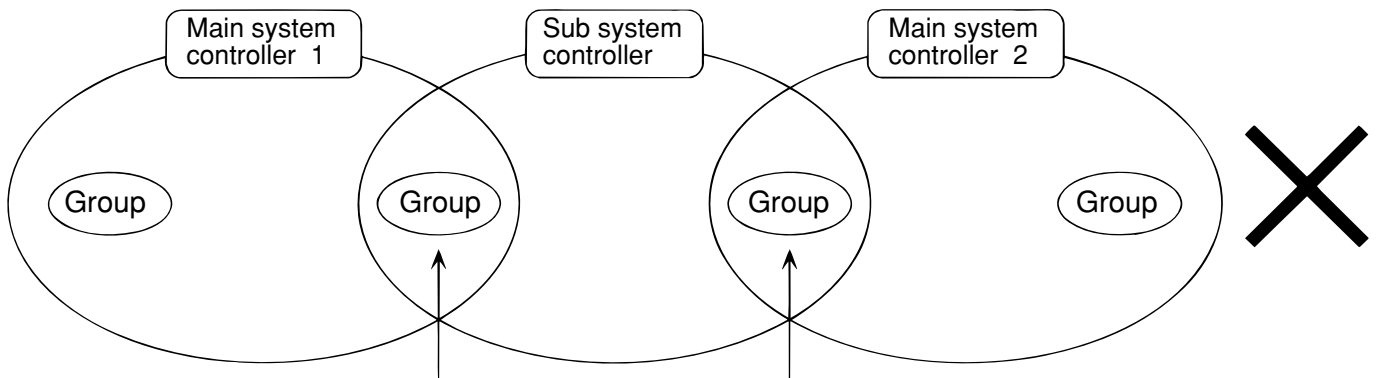

3 - 2 Display Screen

Overall status lamp
 The lamp indicates the unit operation condition.
 ON.....During operation
 OFF.....All group are stopping
 BLINKING.....Malfunction

Operation setting function

Each operation and monitor of unit is performed in collective or group unit. Refer to section "4. User operation (page 10)" for the detail of operation methods.

NOTE: The temperature setting includes a function to switch the display between Celsius (°C) or Fahrenheit (°F) (page 34).

Operation monitor function

ON/OFF operation and monitor of unit are performed. Refer to section "4. User operation (page 10)" for the detail of operation methods.

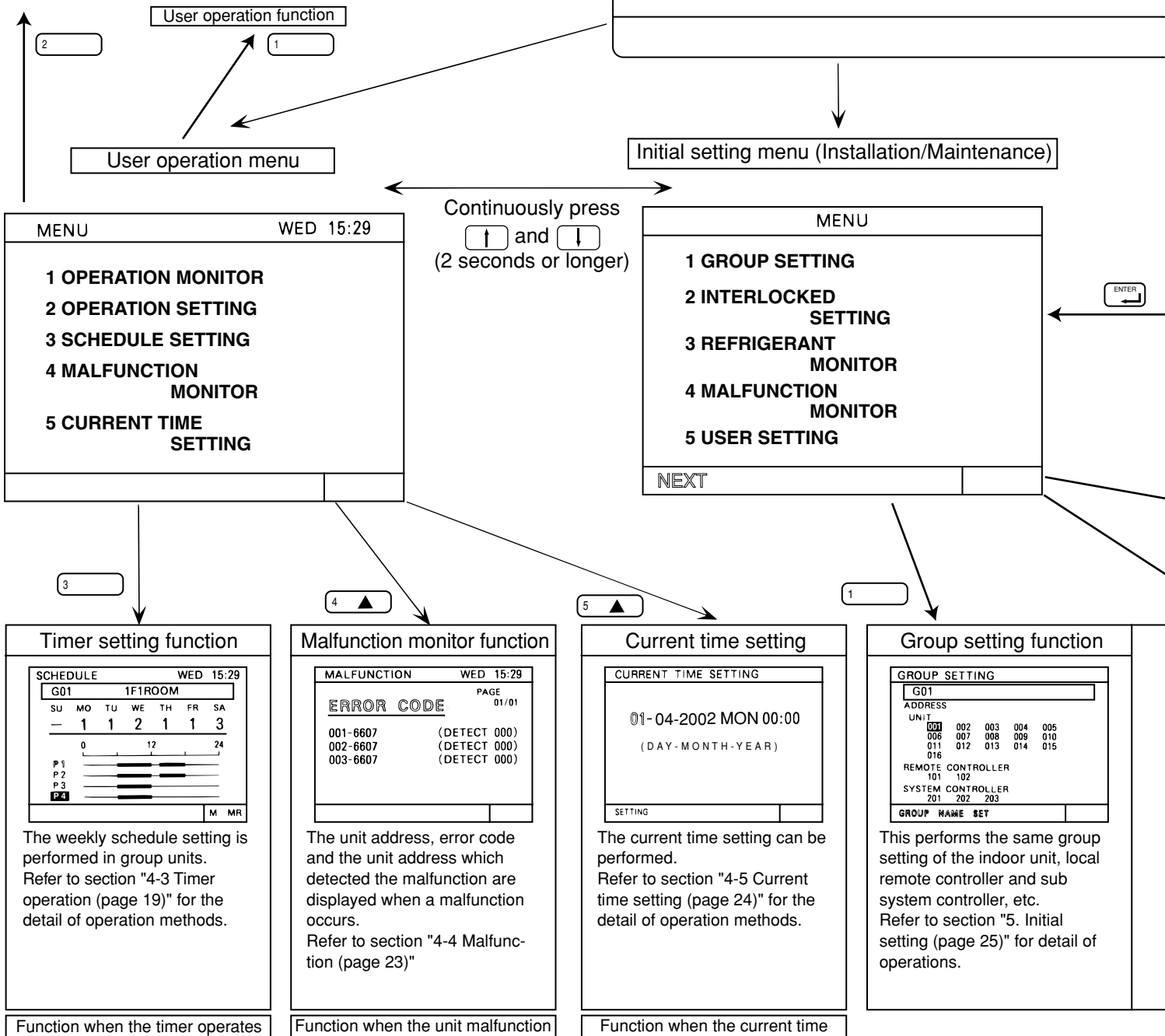
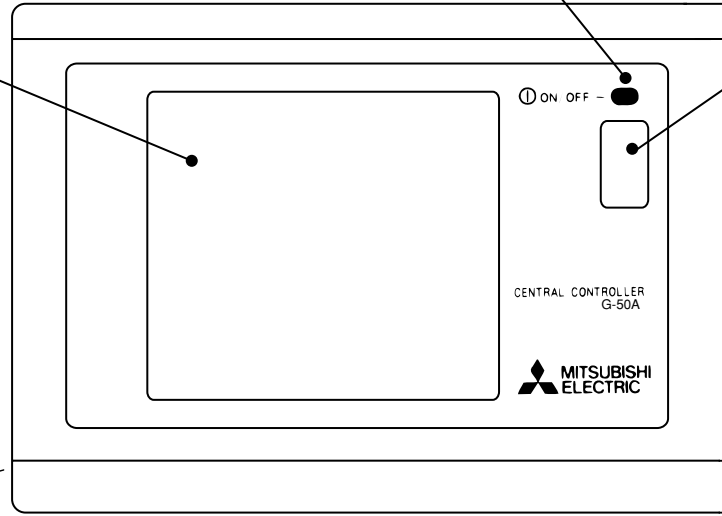

Collective operation switch

If this switch is pressed during the operation, a whole group stop is performed.

The collective operation switch can be performed in the user setting mode for any screen. (Excluding menu screen)

LAN changeover switch

Refer to section "5. Initial setting (page 25)" for explanation of the operation of these switches.

LCD contrast adjustment knob

LAN status lamp

Orange LED indicates action and green LED indicates link.

Service LAN connector

Refer to section "5. Initial setting" for an explanation of this connector.

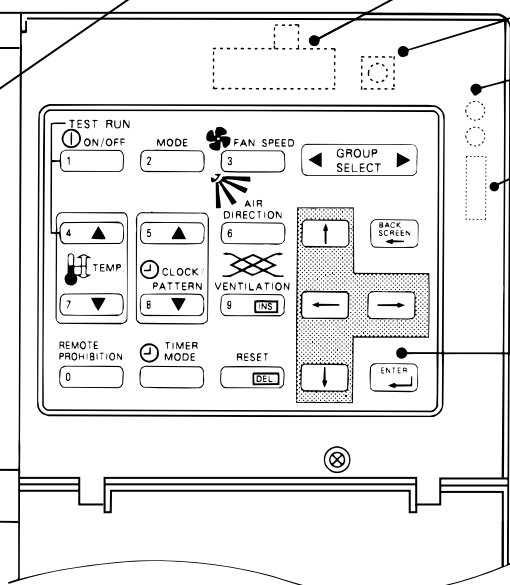

Rear side

Operation panel

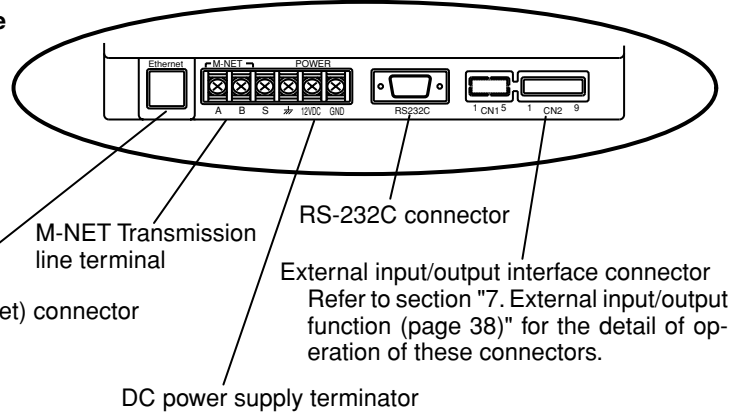

LAN (Ethernet) connector

M-NET Transmission line terminal

RS-232C connector

External input/output interface connector
Refer to section "7. External input/output function (page 38)" for the detail of operation of these connectors.

DC power supply terminator

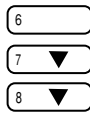
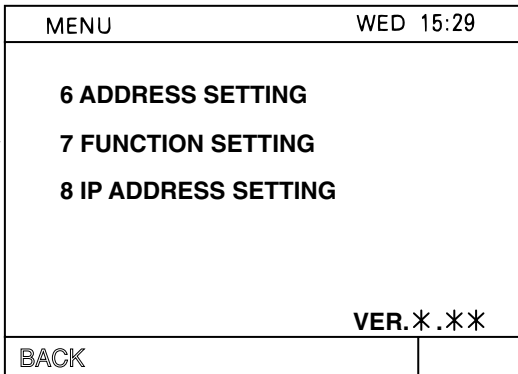

M-NET address setting	Function select setting	IP address setting
<p>ADDRESS SETTING</p> <p>M-NET ADDRESS: 000</p>	<p>FUNCTION SETTING</p> <p>ON: [1-8] OFF: []</p>	<p>IP ADDRESS SETTING</p> <p>IP ADDRESS: 192.168.001.001</p> <p>SUBNET MASK: 255.255.255.000</p>
<p>Display, or sets, the controller M-NET address. Refer to section "5. Initial setting (page 25)" for a detailed explanation of operation.</p>	<p>Sets the function of the controller. Refer to section "5. Initial setting (page 25)" for a detailed explanation of operation.</p>	<p>Sets the LAN IP address. Refer to section "5. Initial setting (page 25)" for a detailed explanation of operation.</p>

Required function for initial settings

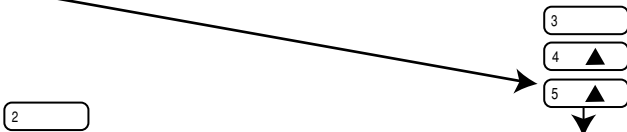

Interlocked setting function	User setting function																				
<p>INTERLOCKED SETTING</p> <p>INTERLOCKED UNIT ADDRESS: 041</p> <p>UNIT ADDRESS</p> <table border="1"> <tr><td>001</td><td>002</td><td>003</td><td>004</td><td>005</td></tr> <tr><td>006</td><td>007</td><td>008</td><td>009</td><td>010</td></tr> <tr><td>011</td><td>012</td><td>013</td><td>014</td><td>015</td></tr> <tr><td>016</td><td></td><td></td><td></td><td></td></tr> </table>	001	002	003	004	005	006	007	008	009	010	011	012	013	014	015	016					<p>USER SETTING</p> <p>1) OPERATION MONITOR</p> <p>GROUP NO. NAME</p> <p>UNIT ADDRESS</p> <p>SCHEDULE DATA</p> <p>SET-BACK/SET TEMP</p> <p>NONE</p> <p>2) FILTER SIGN</p> <p>NONE INDICATE</p> <p>3) GROUP NO. DISPLAY</p> <p>NONE INDICATE</p> <p>4) 2001-1-1-1-1-2001</p> <p>5) ROOM TEMPERATURE</p> <p>NONE INDICATE</p> <p>6) TEMP. UNIT C/F</p> <p>7)</p>
001	002	003	004	005																	
006	007	008	009	010																	
011	012	013	014	015																	
016																					
<p>This function sets either single or multiple indoor units, the LOSSNAY or any other OA processing unit that interlocking operates, as units in the same operation. Refer to section "5. Initial settings (page 25)" for detail of operations.</p>	<p>The function selections of the display method and timer settings that is displayed on the screen. Refer to section "5. Initial settings (page 25)" for detail of operation.</p>																				

Required function for initial settings

Refrigerant monitor function	Malfunction log monitor																																									
<p>REFRIGERANT MONITOR</p> <p>OUTDOOR ADDRESS 51</p> <p>BC/OS ADDRESS 5.2</p> <p>UNIT ADDRESS</p> <table border="1"> <tr><td>01</td><td>02</td><td>03</td><td>04</td><td>05</td><td>06</td><td>07</td></tr> <tr><td>08</td><td>09</td><td>10</td><td>11</td><td>12</td><td>13</td><td>14</td></tr> <tr><td>15</td><td>16</td><td></td><td></td><td></td><td></td><td></td></tr> </table>	01	02	03	04	05	06	07	08	09	10	11	12	13	14	15	16						<p>MALFUNCTION LOG</p> <p>PAGE 01/01</p> <table border="1"> <tr><td>18-04-2002</td><td>19:01</td></tr> <tr><td>001-6607 (DETECT 000)</td><td></td></tr> <tr><td>16-04-2002</td><td>12:45</td></tr> <tr><td>014-6602 (DETECT 014)</td><td></td></tr> <tr><td>12-04-2002</td><td>03:23</td></tr> <tr><td>003-6607 (DETECT 000)</td><td></td></tr> <tr><td>05-04-2002</td><td>09:12</td></tr> <tr><td>012-6607 (DETECT 012)</td><td></td></tr> <tr><td>01-04-2002</td><td>23:56</td></tr> <tr><td>001-6607 (DETECT 000)</td><td></td></tr> </table>	18-04-2002	19:01	001-6607 (DETECT 000)		16-04-2002	12:45	014-6602 (DETECT 014)		12-04-2002	03:23	003-6607 (DETECT 000)		05-04-2002	09:12	012-6607 (DETECT 012)		01-04-2002	23:56	001-6607 (DETECT 000)	
01	02	03	04	05	06	07																																				
08	09	10	11	12	13	14																																				
15	16																																									
18-04-2002	19:01																																									
001-6607 (DETECT 000)																																										
16-04-2002	12:45																																									
014-6602 (DETECT 014)																																										
12-04-2002	03:23																																									
003-6607 (DETECT 000)																																										
05-04-2002	09:12																																									
012-6607 (DETECT 012)																																										
01-04-2002	23:56																																									
001-6607 (DETECT 000)																																										
<p>The unit addresses are displayed for each refrigerant. Refer to section "6. Maintenance (page 36)" for detail of operation.</p>	<p>A malfunction logging which can store a maximum of 64 items that can be monitored. Refer to section "6. Maintenance (page 36)" for detail of operation.</p>																																									

Start-up and maintenance functions

4. User operation

Used the following two screens when user operation is performed.

- | | |
|--------------------------------|--|
| Operation monitor screen | This screen displays ON/OFF and malfunction condition of unit. G-50A normally displays this screen. |
| Operation setting screen | The unit operations can be performed by individual group or collective operation. These operation include the ON/OFF, operation mode, fan speed, temperature setting, air direction, ventilation setting, timer operation ON/OFF, local remote controller prohibition and filter sign reset are performed by group or collectively. In addition, this screen can also displays the room temperature of each group. |

- The collective operation can be performed on any screen (except for the menu screen) in the user operation mode.

<Shifting to the operation monitor screen and operation setting screen>

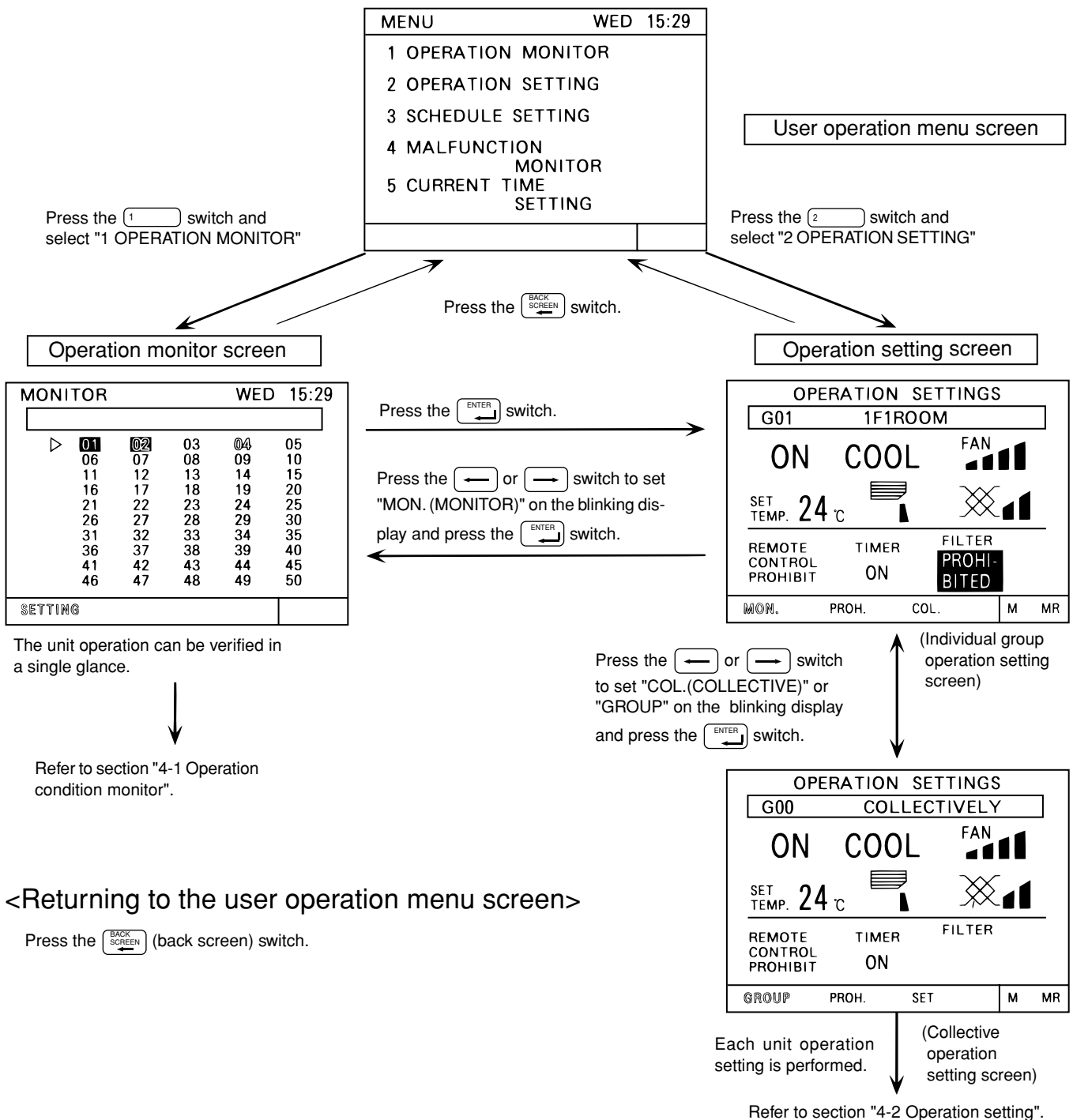

<Returning to the user operation menu screen>

Press the **BACK SCREEN** (back screen) switch.

4 - 1 Operation condition monitor



- This function displays the ON/OFF/Malfunction status of specific units or group.
- ON/OFF/Malfunction status is shown by the indication corresponding to the unit or group appearing in inverse, normal or blinking display.
- The user may select display items by unit address, group number or group name.
Refer to section "5-7 User setting (page 34)" for detail of user setting.
- During the user operation mode, this screen returns from any screen if there is no operation for approximately 10 minutes.

(1) Operation Method

- Note that operation is different for each of the following display methods.



<Unit address display>

MONITOR		WED 15:29	
G00		COLLECTIVELY	
001	002	003	004
006	007	008	009
011	012	013	014
016	017	018	019
021	022	023	024
026	027	028	029
031	032	033	034
036	037	038	039
041	042	043	044
046	047	048	049
050			
SETTING			

- ① Press the  switch to change the display group in desired operation and monitor.
- ② When displaying the units in a given group, press the  switch turn all the units in that group ON or OFF.



<Group number display>

MONITOR		WED 15:29	
▷ 01		02	
06	07	08	09
11	12	13	14
16	17	18	19
21	22	23	24
26	27	28	29
31	32	33	34
36	37	38	39
41	42	43	44
46	47	48	49
50			
SETTING			

- ① Press the  switch to move the "▷" select the group number to be operated.
- ② Press the  switch to set the displayed group unit is indicated by the "▷" symbol to the on/off mode.

<Group name display>

MONITOR		WED 15:29	
▷ 1F1		1F2	
2F1	2F2	2F3	2F4
3F1	3F2	3F3	
SETTING			

- ① Press the  switch to move the "▷" symbol. Select the group name to be operated.
- ② Press the  switch to set the displayed group unit is indicated by the "▷" symbol to the on/off mode.

*Displays up to the first 3 characters of the set group name.

(2) Display contents

Reverse: ON		Normal: OFF	
MONITOR		WED 15:29	
G00		COLLECTIVELY	
001	002	003	004
006	007	008	009
011	012	013	014
016	017	018	019
021	022	023	024
025			
SETTING			

Blinking: Malfunction during units is off.
Blinking and Reverse: Malfunction during unit is on.

*When a malfunction occurs, refer to section "4-4 Malfunction (page 23)".

4 - 2 Operation setting

• There are two methods for the operation, performing the operation classified by groups or collective operation.

4 - 2 - 1 Group operation setting

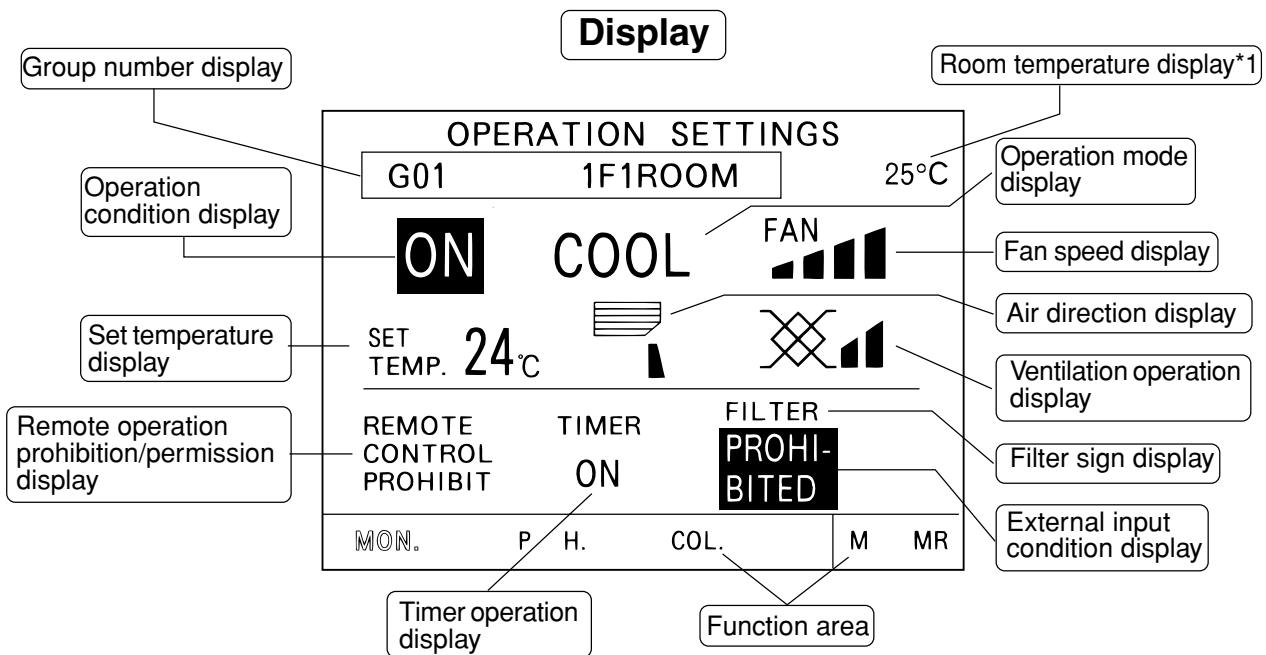

No.	Name of switches	Function	Display
①	ON/OFF switch	The ON/OFF condition of the displayed group is switched.	<p>Operation status display</p> <p>→ [ON] → [OFF] →</p> <p>* When there is an interlocked OA processing unit or LOSSNAY, turning this switch ON starts operation in a [High] ventilated state.</p>
②	Operation mode switch	Used to the type of the operation mode selection. Note: Operation mode can be selected according to the function of unit. If the unit is only cooling type HEAT/AUTO mode may not appear on the display. Refer to the instruction manual of the air conditioner for more detail.	<p>Each time to push the switch, a mode is selected in a sequence that goes from COOL, DRY, FAN, AUTO, HEAT and back to AUTO for air conditioner group.</p> <p>→ COOL → DRY → FAN → AUTO → HEAT →</p> <p>On the group composed of independent LOSSNAY, operation mode is selected in a sequence that goes from HEAT RECOVERY, AUTO, BY-PASS and back to HEAT RECOVERY.</p> <p>→ (HEAT RECOVERY) → AUTO → BY-PASS →</p>
③	Fan speed switch	The fan speed can be switched to four levels. Switching may be 3 levels or 2 levels, depending on the model.	<p>Fan speed display</p> <p>* Indicates AUTO (On the version 3.10 or later, this symbol appears if the AUTO function is available on the indoor unit.)</p> <p>4 levels</p> <p>→ FAN → FAN → FAN → FAN → FAN* →</p> <p>2 levels</p> <p>→ FAN → FAN → FAN* →</p> <p>3 levels</p> <p>→ FAN → FAN → FAN → FAN* →</p>
④	Temperature setting switch	The setting temperature change is performed.	<p>The setting temperature display.</p> <p>The setting range change according to the operation mode. (1°C unit/2°F unit)</p> <p>COOL/DRY 19 ~ 30°C / 67 ~ 87°F</p> <p>HEAT 17 ~ 28°C / 63 ~ 83°F</p> <p>AUTO 19 ~ 28°C / 67 ~ 83°F</p> <p>NOTE: The temperature setting includes a function to switch the display between Celsius (°C) or Fahrenheit (°F) (page 34).</p>

Operation panel

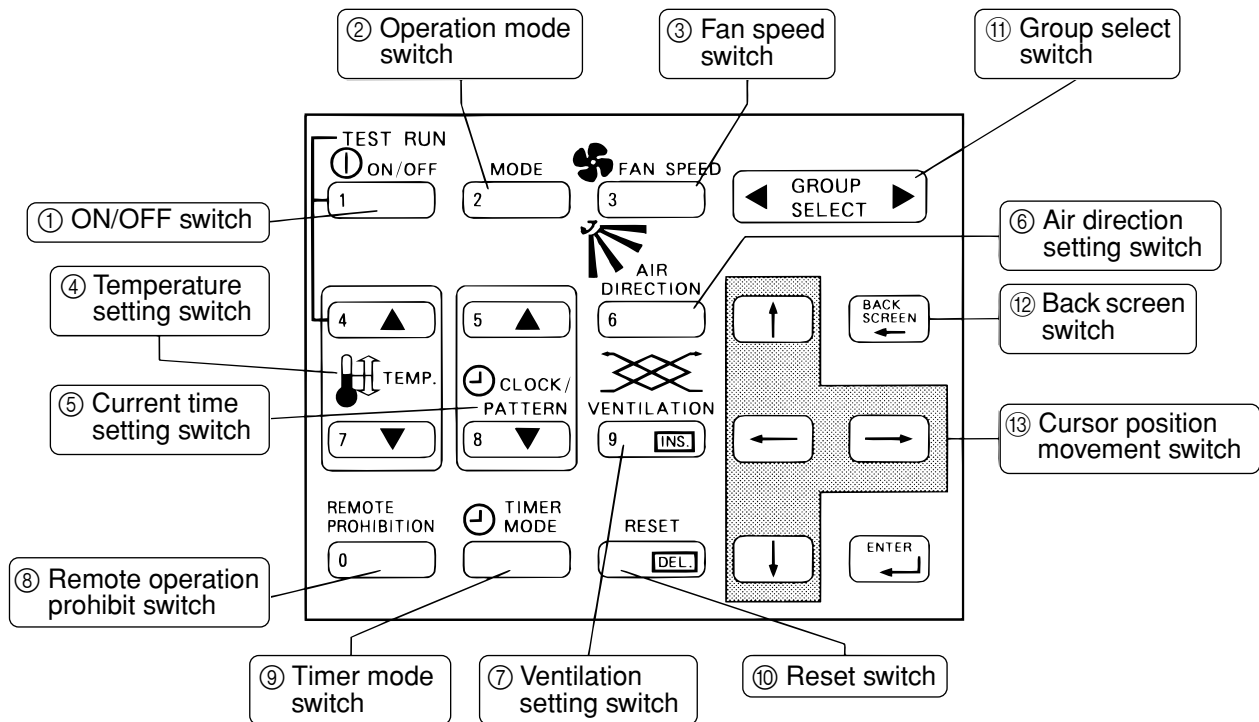

No.	Name of switches	Function	Display
⑤	Current time setting switch	These switches are used when the current time is set.	Refer to section "4-5 Current time setting".
⑥	Air direction setting switch	The Air flow direction can be selected. The air flow direction can be selected to four directions and swing operation (auto vane).	<p>Air flow direction</p> <p>* On the version 3.10 or later, these airflow direction icons appear if the corresponding functions are available on the indoor unit.</p>
⑦	Ventilation setting switch	The operation mode of the interlocked ventilation can be performed. *Where there is no interlocked ventilation, the operation of this switch is invalid. * "Ventilation" is OA processing unit or LOSSNAY.	<p>Ventilation volume setting display</p>
⑧	Remote operation prohibit switch	Used to prohibit for the local remote control.	PROHIBIT: Local remote control specified on the prohibit setting screen is not possible. PERMIT: Local remote control is possible.
⑨	Timer mode switch	The timer operation can be performed according to a previously set operation pattern.	Timer operation display [ON] → [OFF]
⑩	Reset switch	The filter sign display reset is performed. The reset processing is completed by pressing this switch two times.	Filter display [Filter] → No display
⑪	Group select switch	The display group is changed.	Group number display This switch displays 1 ~ 50 group numbers. The switch can also display group names.
⑫	Back screen switch	Use to back to the user menu screen.	The menu screen will be returned.
⑬	Cursor position switch	The position of a cursor can be moved when a cursor is appear.	The cursor position (blinking) moves.

*1: Room temperature can be displayed by selecting the room temperature display function per "5-7 User Setting" (but limited to indoor unit group).

(1) Local remote control operation prohibition setting

- G-50A can prohibit the operation of item such as connected local remote controller or sub system controller for each group. The prohibit items are ON/OFF operation, operation mode, temperature setting and filter sign reset operation.

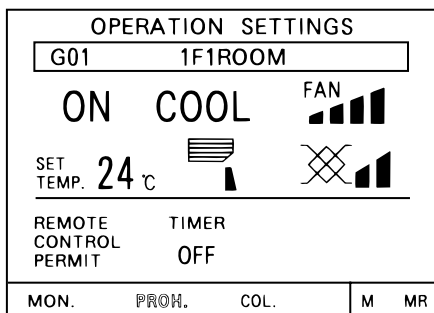

- ① Press the switch to display the group that the operation prohibition setting will be performed.
- ② Press the or switch to set "PROH. (PROHIBIT)" on the blinking display and press switch.

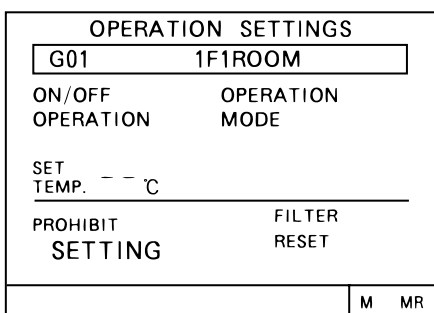

- ① The prohibit setting screen is displayed.
- ② Press the operation switch for the items to be prohibited.
 - When the ON/OFF operation is to be prohibited :
 - When the operation mode is to be prohibited :
 - When the setting temperature is to be prohibited : or
 - When the filter sign reset is to be prohibited :

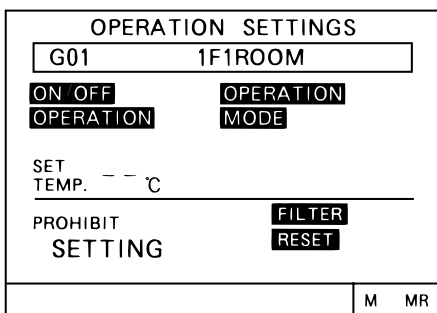

- ① The items selected for prohibition are shown in reverse display.
- ② After setting of prohibit item, press the switch to go back to the operation setting screen.

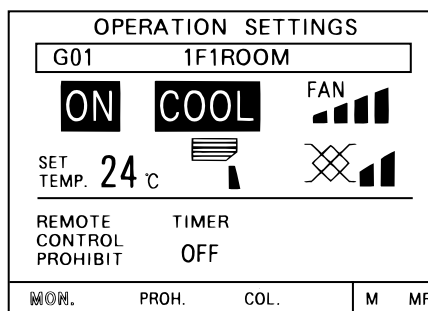
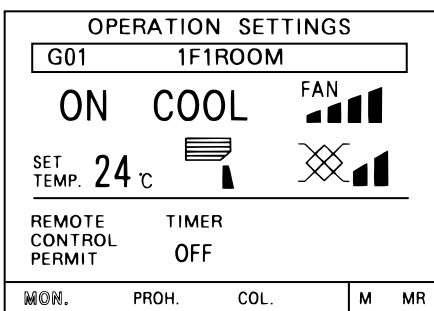

- ① The operation setting screen is displayed.
- ② Press the switch to set "PROHIBIT [ON]".

Remote operation prohibition/permission display will change [PERMIT] to [PROHIBIT] and the prohibited item set on the prohibit setting screen are shown in reverse display.
The prohibit setting is completed.

NOTE:

- The system controller that performed the local remote control operation prohibition setting can operate the prohibited items.
- When the No.4 function select is set ON, the prohibit setting of the local remote control operating cannot be made. For details, refer to "5-3 Function setting".
- In a LOSSNAY group, the operations of only the "ON/OFF" and "FILTER RESET" functions can be prohibited.
- When an M-NET remote controller is used, it must be properly registered to the group for the G-50A unit to be able to prohibit its operation.

(2) G-50A operation prohibition

- The operation of this controller is prohibited when an operation prohibition setting for this controller is received from a system controller other than this controller or when an external input signal is used.

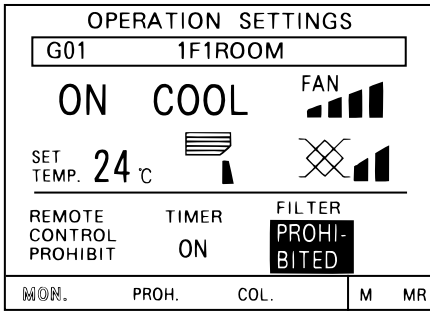



The **PROHIBITED** is displayed and the prohibition operation is display in reverse display when operation of this controller is prohibited by another system controller or an external input signal used. The prohibition operation which is displayed in reverse display is not possible to operate in this condition.

NOTE:

- If the Level Run/Stop function is controlled via an external input, local operation of the Run/Stop button will be prohibited, and the timer operation function will also be prohibited.
- If the Emergency Stop function is controlled via an external input, local operation of the Run/Stop button during emergency stop status will be prohibited, and the timer operation function will also be prohibited.

(3) Using the function area

To select the function from the function area, use the  or  switch to move the cursor to the blinking to the function of your choice and press the  switch. The current cursor position appears as a blinking indication on screen.

- MON. (MONITOR) : Shift to the operation monitor screen.
- PROH. (PROHIBIT) : Shift to the prohibit setting screen.
- COL. (COLLECTIVE) : Shift to the collective operation setting screen.
- M (MEMORY) : Stores the setting currently shown on the screen in memory.
- MR (MEMORY READ) : Reads the setting stored in memory and activates them for the currently displayed group.

4 - 2 - 2 Collective operation setting

- A collective operation setting and a collective prohibit setting can be performed for all the group managed by this controller at one time.

(1) Collective operation setting

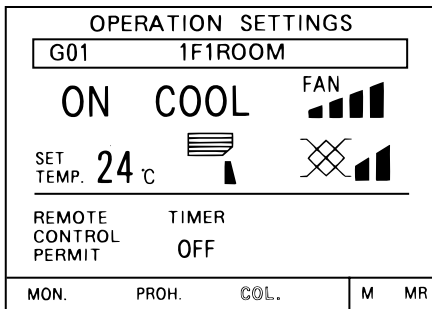

- ① Press the switch to set "COL. (COLLECTIVE)" in blinking display and press the switch on the group operation setting screen.

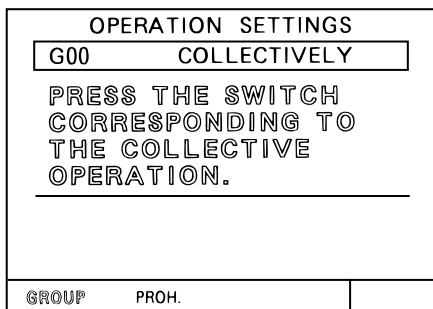

- ② The collective operation setting initial screen is displayed.
- ③ Select the items for operation setting on the collective operation setting initial screen.
The operation method is same as described in section "4-2-1 Group operation setting" (Page 12).

NOTE: The items which were not set, remain set to the same condition that were set before the collective operation was performed.

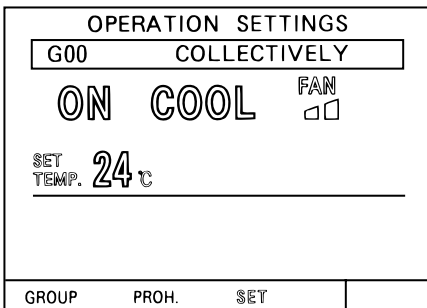

- ④ The items selected for the operation blink on the collective operation setting screen.
- ⑤ When all setting are completed, press the switch to display the "SET" in blinking display for the indicated function area.
- ⑥ Press the switch one time to complete this setting.

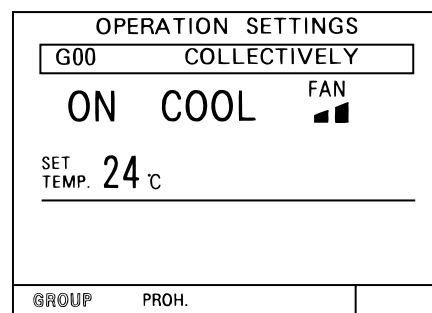
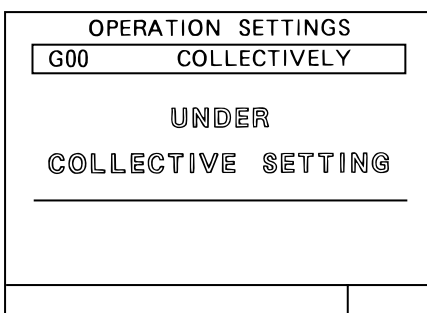

The collective setting is executed.
The collective setting takes approximately 20 seconds.

The collective setting is completed when the previous items light. (After the setting are completed, start from step ③ to perform operation again if change operation are required.)

NOTE: The display of setting contents is erased when shift to another screen.

(2) Collective prohibit setting

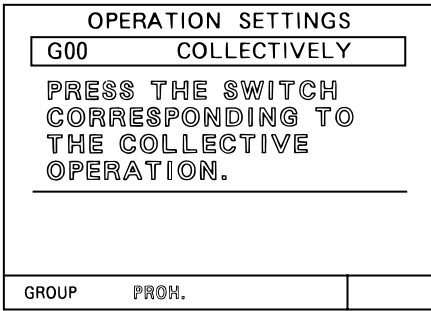

- ① Press the switch to set "PROH. (PROHIBIT)" in blinking display and press the switch on the collective operation setting initial screen.

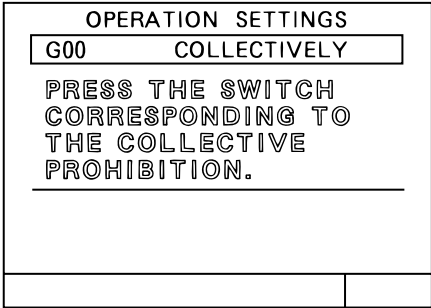

- ② The collective prohibit setting initial screen is displayed.
- ③ Select the items to be prohibited or permitted on the collective prohibit setting initial screen.
- Each time to press the switch corresponding to the prohibition item, the prohibition or permission is selected.
- Prohibition setting: The prohibited item is displayed in reverse with blinking.
- Permission setting: The permitted item is displayed with blinking.
- The selection method concerning to prohibit/permit item is same as described in section "4-2-1 (1) Local remote control operation prohibit setting" (page 14).

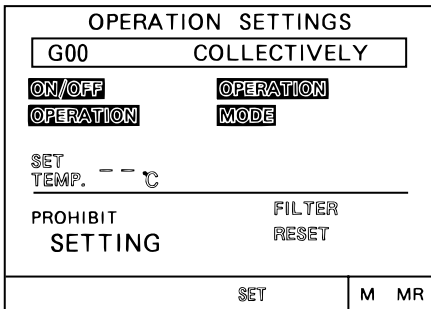

- ④ The items selected for the prohibition or permission are displayed with blinking.
- And the "SET" is displayed with blinking in the function area.
- ⑤ When all setting are completed, press the switch one time to complete this settings.

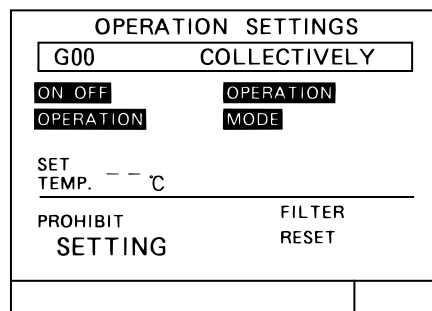
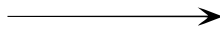
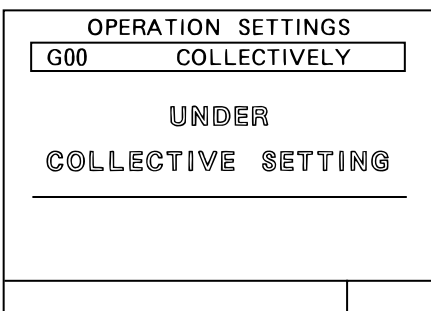



- ⑥ The collective prohibit setting is excused.
- The collective prohibit setting takes approximately 20 seconds.
- ⑦ The collective setting prohibition/permission item setting is completed when the previous item light.
- ⑧ After setting of prohibit/permit items, press the switch to back to the collective operation setting initial screen.

OPERATION SETTINGS	
G00	COLLECTIVELY
PRESS THE SWITCH CORRESPONDING TO THE COLLECTIVE OPERATION.	
GROUP	PROH.

- ⑨ The collective operation setting initial screen is displayed.
- ⑩ Press the  switch to set "REMOTE CONTROL [PROHIBIT]".

OPERATION SETTING	
G00	COLLECTIVELY
REMOTE CONTROL PROHIBIT	
GROUP	PROH. SET

- ⑪ Remote operation prohibition/permission display ("REMOTE CONTROL [PROHIBIT]") is displayed with blinking.
- ⑫ Press the  or  switch to display the "SET" in blinking display for the indicated function area.
Press the  switch one time to complete the collective prohibit setting.

OPERATION SETTING	
G00	COLLECTIVELY
UNDER COLLECTIVE SETTING	

- ⑬ The collective prohibit setting is executed.
It takes approximately 20 seconds.

OPERATION SETTING	
G00	COLLECTIVELY
REMOTE CONTROL PROHIBIT	
GROUP	PROH.

- ⑭ The collective prohibit setting is completed when the remote operation prohibition/permission display is change to be light.

- NOTE:**
- The display of setting contents is erased when shift to another screen.
 - The following restrictions in the collective operation settings.
 1. Temperature setting
The range that can be set falls within 19°C ~ 28°C /67°F ~ 83°F regardless of the operation mode.
 2. Operation mode selection, fan speed selection, air direction, etc., can be collectively set regardless of the functions of the unit. However, actual setting to a unit without functions cannot be performed.
To obtain the correct setting contents, refer to the respective group operation setting screens.
 - When an M-NET remote controller is used, it must be properly registered to the group for the G-50A unit to be able to prohibit its operation.

(1) Schedule pattern (P1~P3) setting

- Follow the procedures described below to set each daily schedule pattern for each group.
- The setting temperature or set-back values setting are also performed in the schedule setting operation. To enter the setting temperature or set-back value setting select SET-BACK or SET TEMP. Accordance with section "5-7 User setting (page 34)" in advance.
- The setting temperature or set-back value selected in this way take effect only during timer operation. Also setback operation is cancelled if the setting temperature is changed using this central controller or a local remote controller.
(The set-back operation resumes at the next timer-ON time)

<Schedule pattern setting (P1 ~ P3, **P4**)>

SCHEDULE		WED 15:29	
G01		1F1ROOM	
SU	MO	TU	WE TH FR SA
-	-	-	- - - -
0		12 24	
P 1	_____		
P 2	_____		
P 3	_____		
P 4	_____		
		M	MR

① Press the switch to display the group in desired a timer setting.

② Press the switch to move the cursor position to the pattern (P1 ~ P3, **P4**) to be setting.

③ Press the switch one time.

SCHEDULE		WED 15:29	
G01		1F1ROOM	
SU	MO	TU	WE TH FR SA
-	-	-	- - - -
P 1		ON	OFF
		--:--	--:--
		8:00	8:00
		--:--	--:--
		--:--	--:--

④ The schedule pattern setting screen is displayed.

⑤ Press the switch to move the cursor position to the first ON (PROHIBITION) time.

P 1		ON	OFF
		8:00	8:00
		--:--	--:--
		--:--	--:--

⑥ Press the / switch to select the ON (PROHIBITION) time.
(Time is changed by 10 minutes unit.)

⑦ Press the switch one time to set ON (PROHIBITION) schedule.
(The cursor moves to the next setting position.)

P 1		ON	OFF
		8:00	12:00
		13:00	20:00
		--:--	--:--

⑧ Perform operation ⑥ to select OFF (PERMISSION) time.

⑨ Perform operation ⑦ to set the OFF (PERMISSION) time.

⑩ Repeat operation ⑥ to ⑨ to set the second and third ON/OFF (PROHIBITION/PERMISSION) schedules in the same manner.
When the second or third ON/OFF (PROHIBITION/PERMISSION) schedule is not used, the characters "--:--" remain display and press the switch one time.

P4	PROH.	PERM.
	00:00	08:00
	12:00	13:00
	20:00	--:--

⑪ To cancel the ON/OFF (PROHIBITION/PERMISSION) time that was set previously, use the switch to move the cursor to the time position to be cancelled and press the switch.

⑫ When the P1 setting are completed, perform operation ② to ⑪ as necessary to perform the setting for P2 or P3 or **P4**.

NOTE: • To disable a function beyond the date line, set the "Disable Start Time" to "00:00".
Also, item **P4** must be enabled for both dates.

(2) Set-back values and setting temperature setting

- Setting the set-back values and setting temperature can be performed only when selecting either "SET BACK" or "SET TEMP" on the user setting screen in the initial setting mode.

Set-back operation

Set-back operation is a method which reduces the air conditioner running cost by controlling the operation with specified time band for lowered load. In other words the unit operates at a few degrees higher for cooling and a few degrees lower for heating in the specified time band.

<<EXAMPLE>> When the reference temperature is 24°C / 75°F and the set-back value is set to 2°C / 4°F.

- Cooling operation: 24°C+2°C=26°C / 75°F+4°F=79°F
- Heating operation: 24°C-2°C=22°C / 75°F-4°F=71°F

Setting temperature operation

This operation sets the temperature when timer ON is set to a predesignated temperature regardless of the operation mode.

<Set-back operation selected>

SCHEDULE		WED 15:29	
G01		1F1ROOM	
SU	MO	TU	WE TH FR SA
-	-	-	- - - -
P 1		ON	OFF
24°C	0°C	8 : 0 0	1 2 : 0 0
0°C	0°C	1 3 : 0 0	2 2 : - -
0°C	0°C	- - : - -	- - : - -

Reference temperature
Set-back value

<Setting temperature selected>

SCHEDULE		WED 15:29	
G01		1F1ROOM	
SU	MO	TU	WE TH FR SA
-	-	-	- - - -
P 1		ON	OFF
24°C	24°C	8 : 0 0	1 2 : 0 0
24°C	24°C	1 3 : 0 0	2 2 : 0 0
24°C	24°C	- - : - -	- - : - -

Setting temperature

- Press the switch to move the cursor position to the set-back reference temperature or setting temperature.

NOTE: The temperature display can be switched between Celsius (°C) or Fahrenheit (°F) (page 34).

SCHEDULE		WED 15:29	
G01		1F1ROOM	
SU	MO	TU	WE TH FR SA
-	-	-	- - - -
P 1		ON	OFF
24°C	0°C	8 : 0 0	1 2 : 0 0
0°C	0°C	1 3 : 0 0	2 2 : 0 0
0°C	0°C	- - : - -	- - : - -

SCHEDULE		WED 15:29	
G01		1F1ROOM	
SU	MO	TU	WE TH FR SA
-	-	-	- - - -
P 1		ON	OFF
25°C	24°C	8 : 0 0	1 2 : 0 0
24°C	24°C	1 3 : 0 0	2 2 : 0 0
24°C	24°C	- - : - -	- - : - -

- Press the / (CLOCK/PATTERN) switch to select the following items.
 - Set-back value:
The reference temperature and set-back value for each ON time period are selected.
 - Setting temperature:
The setting temperature for each ON time period is selected.

- Press the switch to make setting.

- Repeat operations ② and ③ to set the set-back value or setting temperature for each ON/OFF schedule.

- Press the switch, when finished.

* The selecting range:

- The reference temperature for set-back operation
: 19°C ~ 28°C (1°C unit) / 67°F ~ 83°F (2°F unit)
- The set-back value : 0 ~ 9 degree (1 degree unit)
/ 0 ~ 18 degree (2 degree unit)
- The setting temperature: 19°C ~ 28°C (1°C unit) / 67°F ~ 83°F (2°F unit)

(3) Weekly schedule setting



The schedule pattern P1 to P3, local remote control prohibition (P4), **P1** to **P3** of a composite pattern composed of P1 to P3 and P4, and non-timer operation (-) are set for each day.

SCHEDULE		WED 15:29	
G01		1F1ROOM	
SU	MO	TU	WE TH FR SA
-	-	-	- - - -
		0	12 24
P 1	_____		
P 2	_____		
P 3	_____		
P 4	_____		
		M	MR

- Press the switch to display the group in desired weekly schedule setting.

- Press the switch to move the cursor to the pattern position to be set.

SCHEDULE		WED 15:29	
G01		1F1ROOM	
SU	MO	TU	WE TH FR SA
3	—	—	— — — —
0		12	24
P 1	—		
P 2	—		
P 3	—		
P 4	—		
		M	MR





- Press the  /  (CLOCK/PATTERN) switch to select P1 to P4 or (-).
- Press the  switch one time to complete the setting. (The cursor will move to the next setting position.)
- Repeat operations ③ and ④ to assign the schedule pattern to each day.

NOTE: When the No.4 function setting is set ON, P4 cannot be set.

(4) Copying schedule content to other groups (memory, memory read)

- The schedule pattern P1 to P3, weekly schedule pattern, set-back value or setting temperature of one group can be recorded and copied to memory or to another desired group.
- Correction and modification can be easily performed after the copy operation is completed.





SCHEDULE		WED 15:29	
G01		1F1ROOM	
SU	MO	TU	WE TH FR SA
4	1	1	2 1 2 3
0		12	24
P 1	—		
P 2	—		
P 3	—		
P 4	—		
		M	MR

- Display the original group on the weekly schedule setting screen.
- Press the     switch to move the cursor to "M".
- Press the  switch one time to record the setting date in memory.
*To erase date from the memory, return to the user operation menu screen.

0		12	24
P 1	—		
P 2	—		
P 3	—		
P 4	—		
		M	MR

- "M" is displayed in reverse with blinking.
- Press the  switch to select the group to which the data is to be copied.

SCHEDULE		WED 15:29	
G02		1F2ROOM	
SU	MO	TU	WE TH FR SA
—	—	—	— — — —
0		12	24
P 1	—		
P 2	—		
P 3	—		
P 4	—		
		M	MR

- Press the     switch to move the cursor to "MR".
- Press the  switch to set the contents which will be the same as the setting data in memory.

SCHEDULE		WED 15:29	
G02		1F2ROOM	
SU	MO	TU	WE TH FR SA
4	1	1	2 1 2 3
0		12	24
P 1	—		
P 2	—		
P 3	—		
P 4	—		
		M	MR

The same contents are displayed.

The contents stored in memory can be copied to other groups any number of times because these contents will not be erased even if the memory read operation is used.

4 - 4 Malfunction

- The malfunction monitor function is used for conforming to the details of the malfunction condition when a malfunction is displayed on the operation monitor screen.
- The malfunction monitor function can display data describing up to nine malfunctions in the address number sequence on one page. This data contains the unit address where the malfunction occurred, the error code and the unit address where the malfunction was detected.
- After checking the unit address where the malfunction occurred and the error code, please contact your dealer or technical representative as soon as possible.

< Shifting to the malfunction monitor screen >

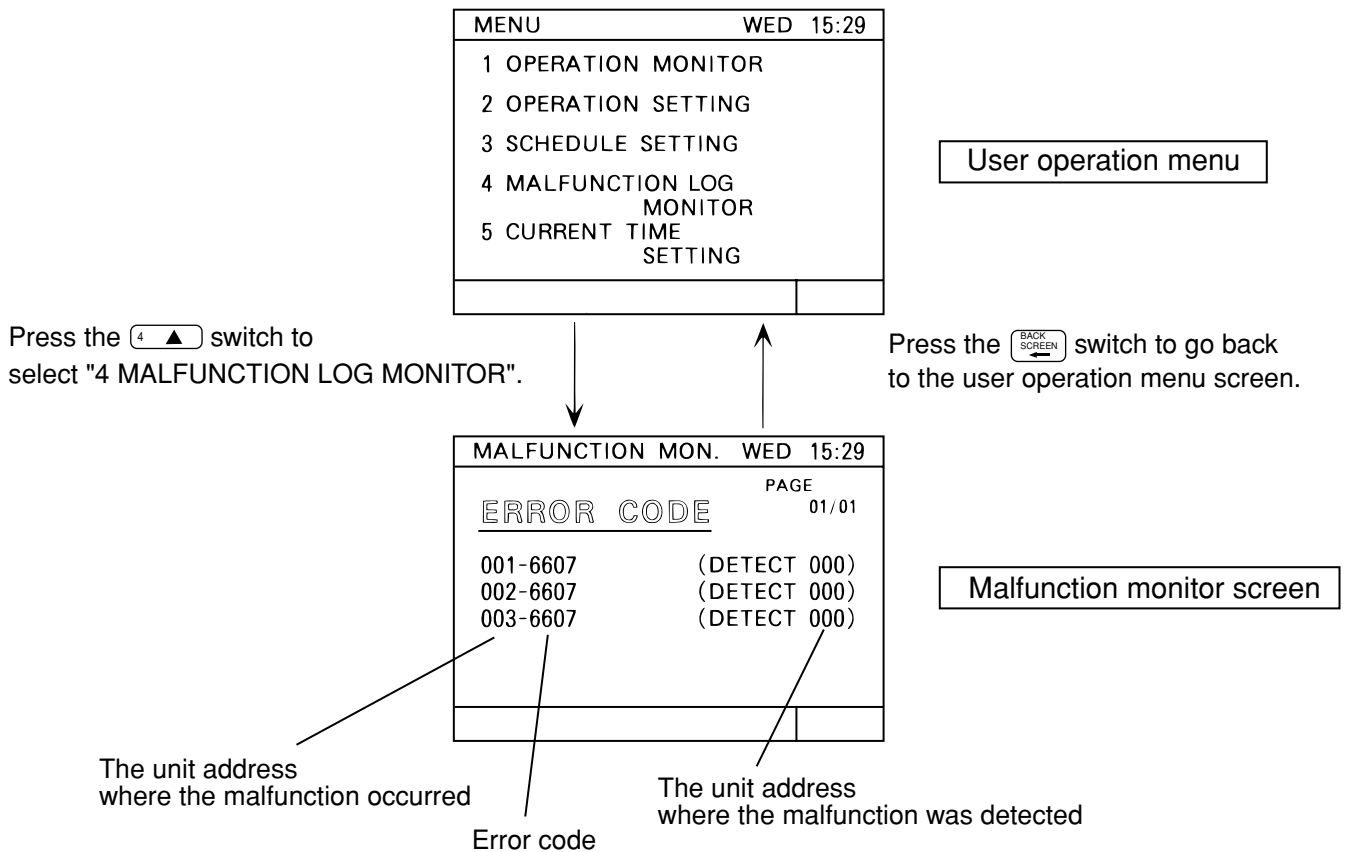

NOTE: When there is no malfunction taking place, [NO ERROR] lights up instead of [ERROR CODE].

Page change operation

The page change operation is performed by the switch.

Pressing the or switch shows the current display page +1.

Pressing the or switch shows the current display page -1.

Malfunction reset operation

Press the reset switch to reset all malfunctions.

The reset operation can be performed on any page.

NOTE: When operation of the G-50A is prohibited, reset operation is invalid.



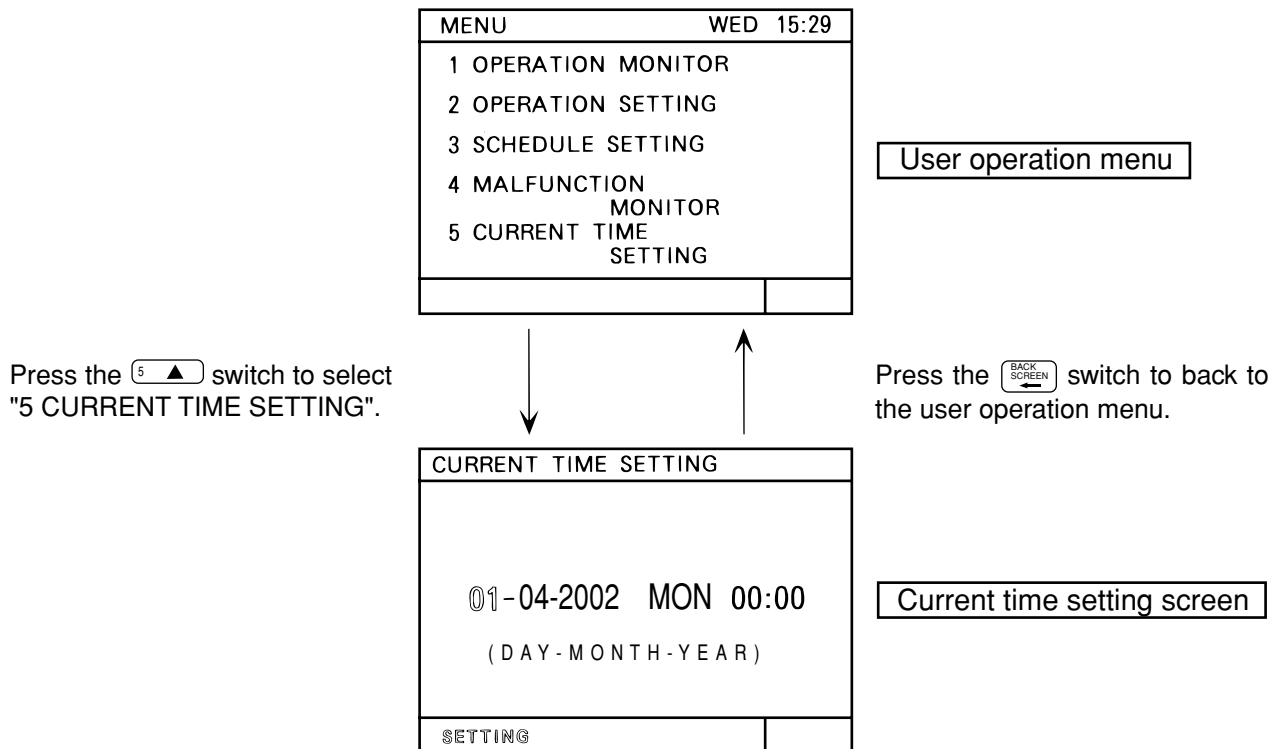

4 - 5 Current time setting

The current time, day, month and year are set on the current time setting screen.

< Shifting to the current time setting screen >



CURRENT TIME SETTING	
15-04-2002 MON 00:00 (DAY-MONTH-YEAR)	
SETTING	

- ① Press the   switch to move the cursor position to be set.
- ② Press the   (CLOCK/PATTERN) switch to set the number or day that is displayed.
- ③ Repeat operations ① and ② to set the date day, month, year and time.
- ④ Where all setting have been completed, press the  switch.

CURRENT TIME SETTING	
15-12-2002 SUN 12:34 (DAY-MONTH-YEAR) done	
SETTING	

- ⑤ The current time setting is executed and "done" is displayed with blinking for two seconds to indicate the current time setting completed and the clock count will start with the second reset to 0.

5. Initial setting

5 - 1 Shifting to initial setting menu

- Shift to the initial setting menu by continuously pressing + (2 seconds or longer) on the user operation menu screen. (Refer to section "3-2".)
Shift to the user operation menu by continuously pressing + (2 seconds or longer) on the initial setting screen. (Refer to section "3-2".)
- When group information is not saved, the following initial setting screen is displayed when power is turned on at this controller.

MENU	WED 15:29
1 ADDRESS SETTING	
2 FUNCTION SETTING	
3 IP ADDRESS SETTING	
4 GROUP SETTING	
PLEASE SET INITIAL SETTING	

5 - 2 M-NET address setting

- (1) Select "6 ADDRESS SETTING" (or "1 ADDRESS SETTING").
- (2) Set the controller address by pressing the to switches (000,201 ~ 250).
- (3) When the switch is pressed after setting, the screen returns.

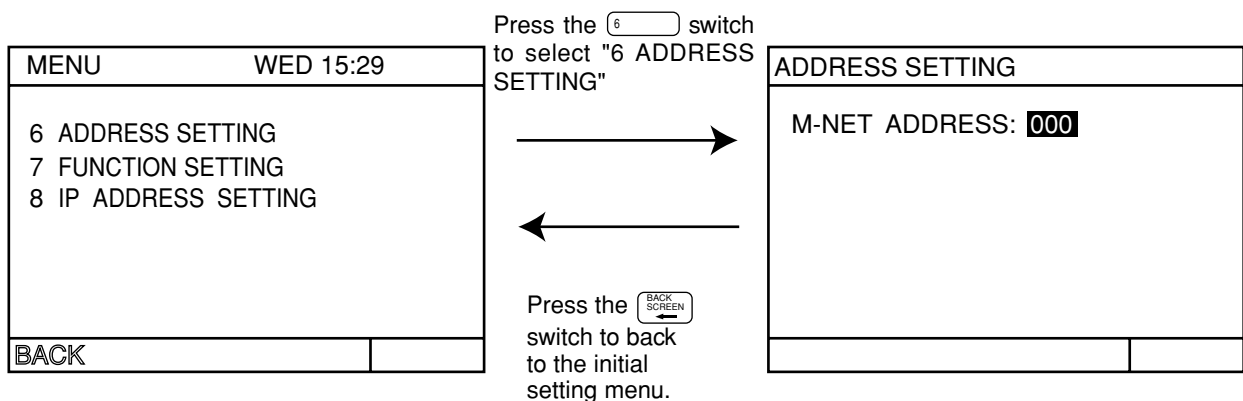

- When the controller is shipped from the factory, the address is set to "000".
(Always set the address to "000" When the K transmission converter is managed.)

NOTE: Observe the following precautions when this controller manages the M-NET models and K control models by using the K transmission converter (PAC-SC25KAA).
Refer to the K transmission converter instruction manual for further details.

- Address of this controller
Always set the address of this controller to "000".
- Function select setting of this controller
Always set the No.3 function setting to ON.
- Indoor unit address
Set all the M-NET models of indoor units from 001, next, set the address of the K control indoor unit.

Indoor unit address	001 ~ M-NET indoor unit maximum address < K control indoor unit minimum address ~ 050
---------------------	---

* Assign the address of the smallest K-control indoor unit in the group as the group number.

5 - 3 Function setting

- The functions of this controller are set according to the function settings.
- The functions selects are set to OFF when the controller is shipped from the factory.

- (1) Select "7 FUNCTION SETTING" (or "2 FUNCTION SETTING").
- (2) Switch the function by pressing the function No. you want to change, or the to switch of the same number.
Each time the switch is pressed, the ON/OFF state of that No. is switched. (NO. 1 and NO. 2 cannot be changed.)

<Operation example>

- 1) When Input switch was pressed.



- (3) When the switch is pressed at the end of function switching, the screen returns.

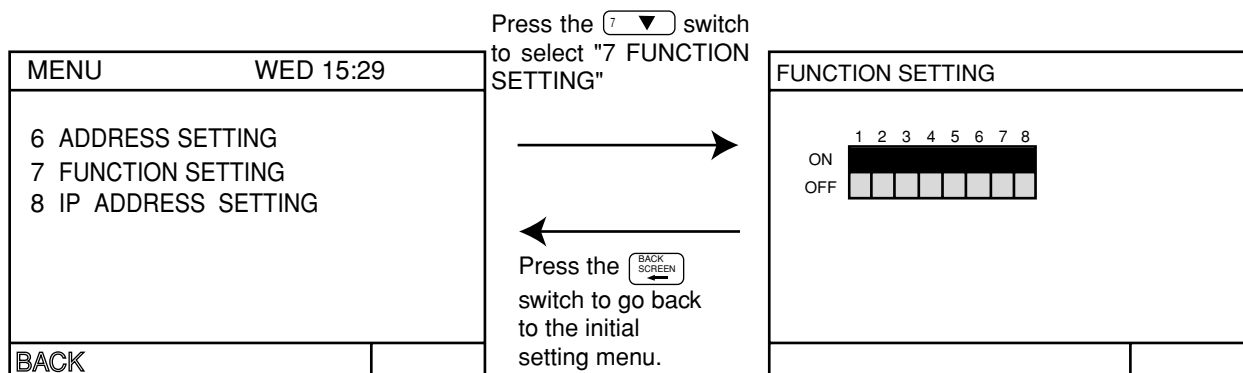

<Function selects>

- No. 1 Reserved for future use (Leave this switch set to OFF)
- No. 2 Reserved for future use (Leave this switch set to OFF)
- No. 3 OFF: No K transmission converter installed / ON: K transmission converter installed
- No. 4 OFF: Operation prohibit setting valid / ON: Operation prohibit setting invalid
- No. 5 OFF: Emergency stop broadcast enabled (Be sure to use) / ON: Emergency stop broadcast disabled
- No. 6
- No. 7 External input changeover (refer to section "7. External input/output function")
- No. 8 The range of a controller which the operation is prohibited
OFF: Both of the system controller and the local remote controller / ON: Only the local remote controller

5 - 4 Group configuration setting

- Registration can be made for the indoor units, local remote controllers and sub system controllers in the same group.
- Registration can be also performed for the group which is composed of only OA processing unit or LOSSNAY. (Independent ventilation group)

<Example for the group configuration>

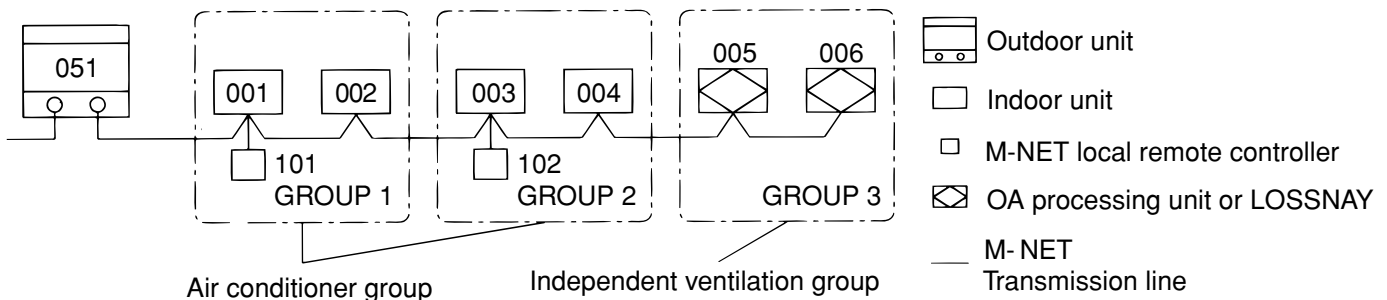

- Supply the power from the power supply unit (PAC-SC50KUA) through the M-NET transmission line and DC line.
- Perform the following procedures to set the group configuration because the interlocked operation setting will not be performed if the group configuration settings have not been performed.

MENU	WED 15:29
1 ADDRESS SETTING 2 FUNCTION SETTING 3 IP ADDRESS SETTING 4 GROUP SETTING PLEASE SET INITIAL SETTING	

- ① When the power is supplied to the controller, the screen shown on the left is displayed.
- ② Press the (or) switch to select "1 GROUP SETTING" (or "4 GROUP SETTING").

GROUP SETTING
G01
ADDRESS
UNIT
REMOTE CONTROLLER
SYSTEM CONTROLLER
GROUP NAME SET

The group configuration setting screen is displayed.

- ③ Press the GROUP SELECT switch to display the group number to be set.
- ④ Press the switch to move the cursor to the address display position to be set.
- ⑤ Used the numeric keypad switch to set the address of the indoor unit, local remote controller, sub system controller in the display group number.

<Operation example>

When the indoor unit which address is 012.

- 1) Input "0"
- 2) Input "1"
- 3) Input "2"
- 4) Press the switch 012

* It is also possible just enter "1" "2".

<When the input is incorrect>

Before pressing switch, continue to input the data. After pressing switch, move the cursor to the addresses to be deleted and press the switch to delete these addresses.

NOTE:

- Do not set interlocked ventilation unit such as OA processing unit or LOSSNAY.
- Even if the addresses are input any order, it is switched to a sequence starting with low-order address.
- The independent ventilation unit can not set to the indoor unit group and it can not be set to as an interlocked ventilation unit.

GROUP SETTING	
G01	
ADDRESS	
UNIT	001 002
REMOTE CONTROLLER	
101	
SYSTEM CONTROLLER	
GROUP NAME SET	



GROUP SETTING	
G03	
ADDRESS	
UNIT	005 006
REMOTE CONTROLLER	
SYSTEM CONTROLLER	
GROUP NAME SET	

MENU	WED 15:29
1 GROUP SETTING	
2 INTERLOCKED SETTING	
3 REFRIGERANT MONITOR	
4 MALFUNCTION LOG MONITOR	
5 USER SETTING	
NEXT	

Set all the units and controllers to be registered in the displayed group number.

⑥ Repeat operation ③ to ⑤ to set all groups managed by this controller.

⑦ When all settings are completed, press the  switch.

NOTE:

- When there are M-NET local remote controllers in the system, always be sure to set the local remote controller address. The local remote controller will not operate if the address setting is not performed. However, when the local remote controller is an MA remote controller (PAR-20/21MAA) or K-control type remote controller, setting is not performed.
- If there is a K transmission converter as a component in the system, do not perform the group configurations setting of this controller for the K transmission converter.

⑧ The following initial setting screen is displayed.

When the interlocked operation settings are performed, refer to section "5-5 Interlocked operation setting".



When the group name settings are performed, refer to section "5-6 Group name setting".

When the user settings are performed, refer to section "5-7 User setting".



Additions Group configuration date collective deletion

- Display "G00" in the group configuration setting screen and press the  switch two times continuously to delete the all group configuration data and all interlocked operation data.

NOTE:

- When this unit is set to the sub system controller by the function select, group registration can not be made. However confirmation of the contents of group registration is possible.
- Simultaneously press the  and  keys on the user operation menu screen for 2 seconds to perform group configuration setting. The initial setting menu screen is displayed. Select "1 GROUP SETTING" on the setting menu screen, wait for the group setting screen to appear, and change the setting.

INITIAL SETTING	
PLEASE WAIT	

⑨ When the necessary initial settings are complete, simultaneously press the  and  keys on the user operation menu screen for 2 seconds. When returned to the user operation screen, register processing for the group configuration information and initial set up processing for each unit and each controller is executed. (This process takes approximately 5 ~ 7 minutes.)

5 - 5 Interlocked operation setting

- Registration of interlocked operation of Ventilation unit (OA processing unit and LOSSNAY) with single or multiple indoor unit is performed. All indoor units to be interlocked with ventilation unit for operation should be registered for the interlocking with ventilation unit.

<Example for the interlocked group configuration>

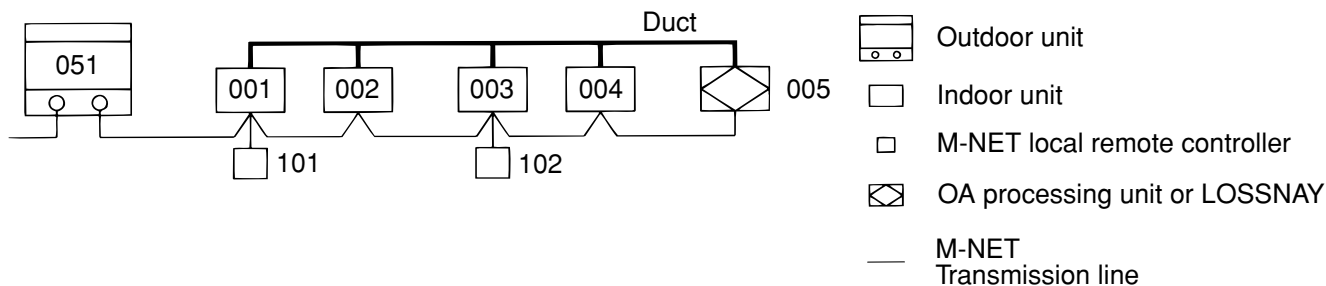

MENU	WED 15:29
1 OPERATION MONITOR	
2 OPERATION SETTING	
3 SCHEDULE SETTING	
4 MALFUNCTION MONITOR	
5 CURRENT TIME SETTING	

- ① Simultaneously press the and keys on the user operation menu screen for 2 seconds.

NOTE: Always perform the mode change operation from the user operation menu. Mode change operation from other screens is ineffective even if performed.

MENU	
1 GROUP SETTING	
2 INTERLOCKED SETTING	
3 REFRIGERANT MONITOR	
4 MALFUNCTION LOG MONITOR	
5 USER SETTING	
NEXT	

- ② Initial setting menu screen is displayed.
- ③ Press the switch to select "2 INTERLOCKED SETTING".

INTERLOCKED SETTING	
INTERLOCKED UNIT ADDRESS	005
UNIT ADDRESS	

- ④ The interlocked setting screen is displayed. Minimum address of the interlocked OA processing unit or LOSSNAY unit which can be set to interlock with indoor unit is displayed on the "INTERLOCKED UNIT ADDRESS" display position. And the cursor is displayed in the unit address display position.
- ⑤ Press the switch to display the address number of the interlocked OA processor unit or LOSSNAY that the setting will be performed on.

INTERLOCKED SETTING	
INTERLOCKED UNIT ADDRESS	005
UNIT ADDRESS	■

⑥ Used the numeric keypad switch to set the address of the indoor unit that operates with displayed interlocked OA processing unit or LOSSNAY.

<Operation example>

When the indoor unit which address is 012.

1) Input "0" 0

2) Input "1" 01

3) Input "2" 012

4) Press the → switch 012 ■■■■

* It is also possible just enter "1" "2".

<When the input is incorrect>

Before pressing → switch, continue to input the data. After pressing

→ switch, move the cursor to the address to be deleted and press the

DEL switch to delete these addresses.

INTERLOCKED SETTING	
INTERLOCKED UNIT ADDRESS	005
UNIT ADDRESS	001 002 003 004 ■

⑦ Set all the indoor units that operate with displayed interlocked OA processing unit or LOSSNAY.

⑧ Repeat operation ⑤ to ⑦ to set the indoor units of all interlocked operation units managed by this controller.

⑨ When all settings are completed, press the BACK SCREEN ← switch.

MENU	
1 GROUP SETTING	
2 INTERLOCKED SETTING	
3 REFRIGERANT MONITOR	
4 MALFUNCTION MONITOR	
5 USER SETTING	
NEXT	

Initial setting screen is displayed.

This ends the interlocked operation setting.

When the interlocked operation settings are performed, refer to section "5-5 Interlocked operation setting".

When the group name settings are performed, refer to section "5-6 group name setting".

When the user setting are performed, refer to section "5-7 user setting".

Simultaneously press the ↑ and ↓ keys on the initial setting menu screen for 2 seconds to complete user operation. After the initial setting processing is completed (The initial setting screen will be displayed), refer to section "4. User operation (page 10)" and perform user operation.

NOTE: When this unit is set to sub system controller by No.2 function select, interlocked operation settings cannot be adjusted. However monitoring of the contents of the interlocked operation settings is possible.

5 - 6 Group name setting

(1) Setting method

- Specify new group name.
- Either alphabet, numeric characters, hyphens or spaces can be used for name setting.
- Maximum of ten characters can be set.
- When the group name is displayed on the operation monitor screen, the first three characters of the group name are displayed.

MENU	
1	GROUP SETTING
2	INTERLOCKED SETTING
3	REFRIGERANT MONITOR
4	MALFUNCTION LOG MONITOR
5	USER SETTING
NEXT	

- ① Press the (or) switch to select "1 GROUP SETTING" (or "4 GROUP SETTING") of the initial setting menu.

GROUP SETTING	
<input type="text" value="G01"/>	
ADDRESS	
UNIT	<input type="text" value="001"/> <input type="text" value="002"/>
REMOTE CONTROLLER 101	
SYSTEM CONTROLLER	
GROUP NAME SET	

- ② The group configuration setting screen is displayed.
- ③ Press the switch to move the cursor to the "GROUP NAME SET".
- ④ Press the switch one time.

GROUP NAME	
<input type="text" value="G01"/>	
← ← ← ← → → → →	
1	2 3 4 5 6 7 8 9 0 -
ABCDEFGHIJKLM	
NOPQRSTUVWXYZ	
M MR	

- The group name setting screen is displayed.
- ⑤ The character " ← " is displayed in reverse.
- ⑥ Press the switch to move the cursor to the desired character.
- ⑦ Press the switch.

GROUP NAME	
<input type="text" value="G01"/> <input type="text" value="M"/>	
← ← ← ← → → → →	
1	2 3 4 5 6 7 8 9 0 - <input type="checkbox"/>
ABCDEFGHIJKLM	
NOPQRSTUVWXYZ	
M MR	

- The selected character is displayed in the group name display area.
- ⑧ Repeat operation ⑥ or ⑦ and set the group name.
When incorrect character is set, refer to section "Group name correction method (page 32)".
- Group name display area

GROUP NAME	
G01	MEETING A █
← ← → → → →	
1 2 3 4 5 6 7 8 9 0 -	
A B C D E F G H I J K L M	
N O P Q R S T U V W X Y Z	
M MR	

⑨ When the group name setting is completed, press the  switch.

GROUP SETTING	
G01	MEETING A
ADDRESS	
UNIT	001 002
REMOTE CONTROLLER	
101	
SYSTEM CONTROLLER	
GROUP NAME SET	

The group configuration setting screen is displayed.



⑩ Repeat operation ③ to ⑨ and perform the group name setting for each group.

⑪ When all the group name settings are complete, press the  switch.

MENU	
1 GROUP SETTING	
2 INTERLOCKED	
SETTING	
3 REFRIGERANT	
MONITOR	
4 MALFUNCTION	
MONITOR	
5 USER SETTING	
NEXT	

⑫ The initial setting menu screen is displayed.

To perform the setting, refer to section "5-7 User setting (page 34)".

Simultaneously press the  and  keys on the initial setting menu screen for 2 seconds to complete user operation.

Next refer to section "4 User operation" and perform user operation.





<Group name correction>

GROUP NAME	
G01	MEETING A █
← ← → → → →	
1 2 3 4 5 6 7 8 9 0 -	
A B C D E F G H I J K L M	
N O P Q R S T U V W X Y Z	
M MR	

Group name cursor
Group name cursor movement mark

When performing corrections to the group name, move the group name cursor to the character to be correct.

Group name cursor movement method

Move the cursor to one of the group name cursor movement mark using the     switch.

• Deletion methods

Move the group name cursor to the character to be deleted and press the  switch to delete the character.







• Insertion methods

Move the group name cursor to the location where character is to be inserted and press the  switch to enter desired space.

(2) Group name copy

- A certain group name can be copied to another group.
(This method use the "M" (memory) and "MR" (memory read) functions.)
- It is convenient to use a group name for other groups because a group name that was copied can also be corrected.





GROUP NAME	
G01	MEETING A ■
← ← ← → → → →	
1 2 3 4 5 6 7 8 9 0 -	
ABCDEFGHIJKLM	
NOPQRSTUVWXYZ	
	M MR

- ① Press the  switch to display the original group on the group name setting screen.
- ② Press the     switch to move the cursor to "M".
- ③ Press the  switch one time to record the setting name in memory.

GROUP NAME	
G01	MEETING A ■
← ← ← → → → →	
1 2 3 4 5 6 7 8 9 0 -	
ABCDEFGHIJKLM	
NOPQRSTUVWXYZ	
	M MR

- ④ "M" is displayed in reverse with blinking.
Recording the setting name to memory is completed.
- ⑤ Press the  switch to select the copy destination group.

GROUP NAME	
G02	■
← ← ← → → → →	
1 2 3 4 5 6 7 8 9 0 -	
ABCDEFGHIJKLM	
NOPQRSTUVWXYZ	
	M MR

- ⑥ Press the     switch to move the cursor "MR".
- ⑦ Press the  switch to read in memory.

GROUP NAME	
G02	MEETING A ■
← ← ← → → → →	
1 2 3 4 5 6 7 8 9 0 -	
ABCDEFGHIJKLM	
NOPQRSTUVWXYZ	
	M MR

- ⑧ Performed the memory read for the group name.
Refer to section "(1) Setting method (page 31)" and perform the correction of the group name.

5 - 7 User setting

- To match the needs for the user this menu is to specify some of the indications and functions that appear on the user operating screen.

MENU	
1	GROUP SETTING
2	INTERLOCKED SETTING
3	REFRIGERANT MONITOR
4	MALFUNCTION MONITOR
5	USER SETTING
NEXT	

- ① Press the  switch to select "5 USER SETTING" on the initial setting menu screen.

USER SETTING	
1	OPERATION MONITOR GROUP NO./NAME /UNIT ADDRESS
2	SCHEDULE DATA SET-BACK/SET TEMP NONE
3	FILTER SIGN NONE/INDICATE
4	GROUP NO. DISPLAY NONE/INDICATE
5	2001-1-1/1-1-2001
6	ROOM TEMPERATURE NONE/INDICATE
7	TEMP. UNIT C/°F

The user setting screen is displayed.

- ② Press the     switch to select the items to be set.

- ③ When all the selection are completed, press the  switch to return to the initial setting menu screen.

Setup condition before delivery from the shop

Item 1. Operation monitor screen display settings

- "GROUP NO." : Groups are indicated by group number on the operation monitor screen.
 "NAME" : Groups are indicated by their first three characters of the group name on the operation monitor screen.
 "UNIT ADDRESS" : Individual units are indicated by their unit address on the operation monitor screen.

Item 2. Setting the set-back value and the setting temperature used in conjunction with schedule operation.

- The set-back value or the setting temperature setting are possible when operation is linked with the schedule operation.
- "SET-BACK" : Allows setting set-back value used in conjunction with ON/OFF patterns during schedule operation.
 "SET TEMP" : Allows setting of the setting temperature used in conjunction with ON/OFF patterns during schedule operation.
 "NONE" : The schedule operation is only performs normal ON/OFF patterns.

Item 3. Setting filter sign indication

- "INDICATE" : Allows the indication of filter sign.
 "NONE" : Filter sign is not indicated.

Item 4. Group number display

- "INDICATE" : Enable display of group number on the operation setting screen and the schedule setting screen.
 "NONE" : Group number is not indicated.

Item 5. Change to the sequence of current time

- "2001-1-1" : Current time indicate in a sequence of year, month and date on the current time setting screen.
 "1-1-2001" : Current time indicate in a sequence of date, month and year on the current time setting screen.

Item 6. Room temperature indication

- "INDICATE" : Indicated every each group
 "NONE" : Not indicated every each group

Item 7. Temperature unit

- "°C" : Setting Centigrade
 "°F" : Setting Fahrenheit

5 - 8 IP address setting

- This function allows setting of the IP address and mask address needed at LAN connection.

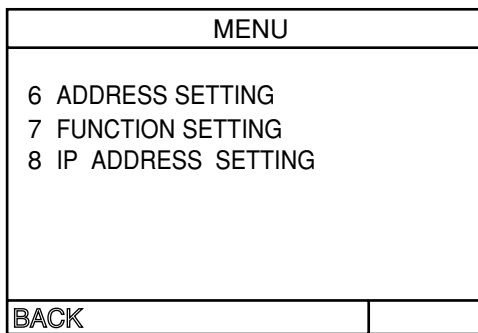

- ① Select the switch select "8 IP ADDRESS SETTING" on the initial setting menu screen.

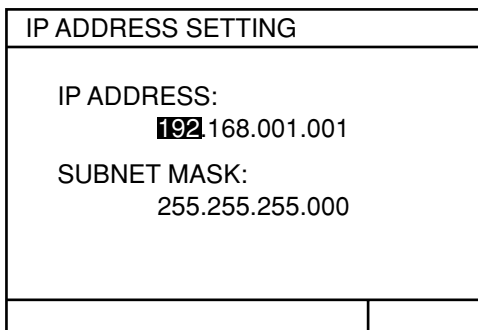

The IP address setting screen appears.

- ② Move the cursor to the address setting position by pressing the , , , and keys.
- ③ Set the address with the 0 to 9 numeric switches.
- ④ When all address setting are complete, return to the initial setting menu screen by pressing switch.

5 - 9 Initial setting tools connection function

- This function connects the initial setting tool PC by LAN.
 - Group setting, interlocked setting, and other information can be downloaded to this unit by using the initial setting tool.
- Refer to the initial setting tool manual for an explanation of the initial setting tool functions and operating procedures.

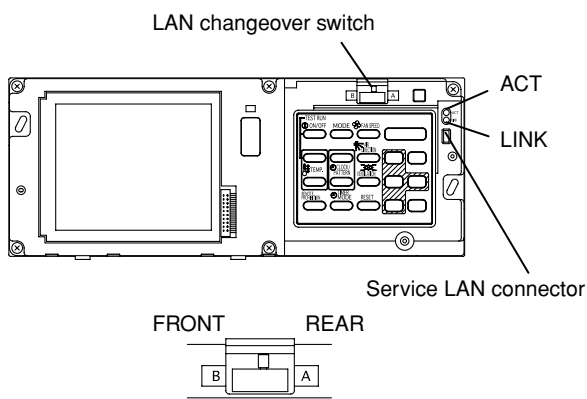

- ① Remove the cover from the controller by inserting a flat blade screwdriver into the gap between the cover and body and twisting the screwdriver.
- ② Use the dedicated cable (sold separately) to connect the initial setting tool PC to the service LAN connector.
- ③ When changed to FRONT with the LAN changeover switch, the initial setting tool PC is connected to the service LAN connector.
- ④ When setting with the initial setting tool is complete, return the LAN changeover switch to the REAR position.

*When a service LAN connector is used, the optional service Model PAC-YG00FA-E is necessary.

NOTE: • The same settings that are made with the Initial Setting Tool can be made from the Initial Setting Web.
• Refer to the Operation Manual for Initial Setting Web for the functions and operation of the Initial Setting Web.

6. Maintenance

6 - 1 Refrigerant system monitor

- This function allows monitoring of the address of the outdoor units, and BC controller connected to the refrigerant system. It is useful for checking address settings, transmission line connection during installation.

MENU	
1	GROUP SETTING
2	INTERLOCKED SETTING
3	REFRIGERANT MONITOR
4	MALFUNCTION MONITOR
5	USER SETTING
NEXT	

① Press the  switch to select "3 REFRIGERANT MONITOR" on the initial setting menu screen.

REFRIGERANT MONITOR	
UNDER MONITORING	
NEXT	

The process for monitoring of the refrigerant system is executed. Please wait.

REFRIGERANT MONITOR	
OUTDOOR ADDRESS 5 1	
BC/OS ADDRESS 5 2	
UNIT	ADDRESS
01 02 03 04 05 06 07	
08 09 10 11 12 13 14	
15 16	
NEXT	

The refrigerant system monitor screen of the lowest outdoor unit address is displayed.

Press the  switch to change the displayed refrigerant system.

When the monitoring is end, press the  switch to back to the initial setting menu screen.

6 - 2 Malfunction log monitor

- This function allows monitoring of a log of the last 64 malfunctions.
- The contents of malfunction and time the malfunction occurred is displayed. The contents of malfunction is the address of the unit where it occurred, the error code and the address of the unit that detected the malfunction.
- This data are remains in the memory even if supplied power is cut off.
- The malfunction log data can be deleted using the malfunction log reset operation. If the malfunction log data is reset after the system is serviced, the log will provide a convenient record of the malfunction that have occurred after that time when the system is next serviced.

MENU	
1	GROUP SETTING
2	INTERLOCKED SETTING
3	REFRIGERANT MONITOR
4	MALFUNCTION LOG MONITOR
5	USER SETTING
NEXT	

- ① Press the  switch to select "4 MALFUNCTION LOG MONITOR" on the initial setting menu screen.

MALFUNCTION LOG	
PAGE 01/01	
18-04-2002	19:01
001-6607 (DETECT 000)	
16-04-2002	12:45
014-6602 (DETECT 014)	
12-04-2002	03:23
003-6607 (DETECT 000)	
05-04-2002	09:12
112-6607 (DETECT 012)	
01-04-2002	23:56
001-6607 (DETECT 000)	

The malfunction log monitor screen is displayed.

- ② Changing pages on the malfunction log monitor screen.

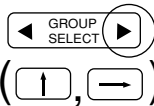

Each time this switch is pressed, the current page +1 is displayed.



Each time this switch is pressed, the current page -1 is displayed.



- ③ Malfunction log reset operation

Press the  switch to clear the malfunction log.

7. External input/output function

- * External signal input requires the external I/O adapter (Model: PAC-YG10HA-E) sold separately.
- * Refer to Instalation Manual for detail.

7 - 1 External input function

(1) The function of external input

- Emergency stop/normal, run/stop and prohibit/enable of local remote controller operation can be controlled for all air conditioners by using a voltage (DC12V or DC24V) contact signal from an external source. (Select with the function select setting.)

No.	Function of external input signal	Function		Remarks
		No.6	No.7	
1	External input signal not used	OFF	OFF	
2	Perform emergency stop with level signal	OFF	ON	During emergency stop, only ON/OFF of the central controller and local remote controller's operation will be prohibit.
3	Perform ON/OFF operation with level signal	ON	OFF	Only the ON/OFF operation of the central controller and the local remote controller will be prohibit.
4	Perform ON/OFF operation, prohibit/permit operation with pulse signal	ON	ON	Set the pulse width while the contact is ON to 0.5 to 1.0 second.

(2) Level signal and pulse signal

① Level signal

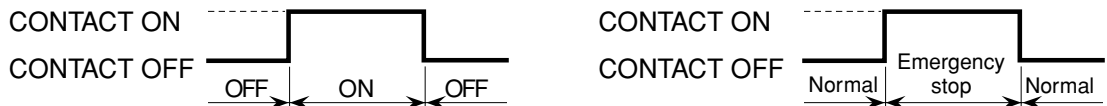

② Pulse signal

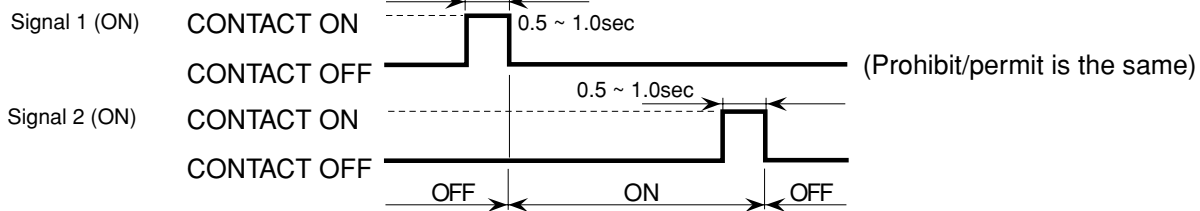

(3) Specification of external input interface

CN2	Lead wire	Emergency stop/normal level signal	ON/OFF level signal	ON/OFF, prohibit/permit pulse signal
No.5	Orange	Emergency stop/normal input	ON/OFF input	ON input
No.6	Yellow	Not used	Not used	OFF input
No.7	Blue	Not used	Not used	Local remote controller prohibit input
No.8	Gray	Not used	Not used	Local remote controller permit input
No.9	Red	Common (DC12V or DC24V)		

(A) Level signal

- ① When the level signal is selected, the operation (only ON/OFF operation) for the central controller and the local remote controller are prohibited (except during normal operation).
- ② When the emergency stop/normal operation signal is selected, the status will be changed from normal operation to emergency stop when the external input signal contact turns OFF to ON, and will be changed from emergency stop to normal operation when external input signal contact turns ON to OFF.
Air conditioning units that came to an emergency stop will remain stopped after the emergency stop is cancelled. Manually start up each unit to restore the previous operation.
- ③ When ON/OFF input signal is selected, the status will be changed from OFF to ON when the external input signal contact turns OFF to ON, and will be changed from ON to OFF when the external input signal contact turns ON to OFF.

(B) Pulse signal

- ① Even if the ON signal is input during ON, the status will remain at the ON status.
- ② When the local remote controller is prohibited, the ON/OFF operation, operation mode selection and temperature setting from the local remote controller is prohibited.
- ③ Set the pulse width (contact ON time) to 0.5 to 1.0 second.

7 - 2 External output function

(1) The function of external output

- The "ON" signal is output when one or more air conditioner are in the ON operation.
- The "Malfunction" signal is output when one or more air conditioner malfunctions.

(2) Specification of external output interface

CN2	Lead wire	Description of each terminal
No.1	Green	Common (0V)
No.2	Black	ON/OFF
No.3	Brown	Malfunction/Normal

- ① "ON" signal and "Malfunction" signal will both be output.

Appendix 1: Initial setting (abridged)

Initial setting list

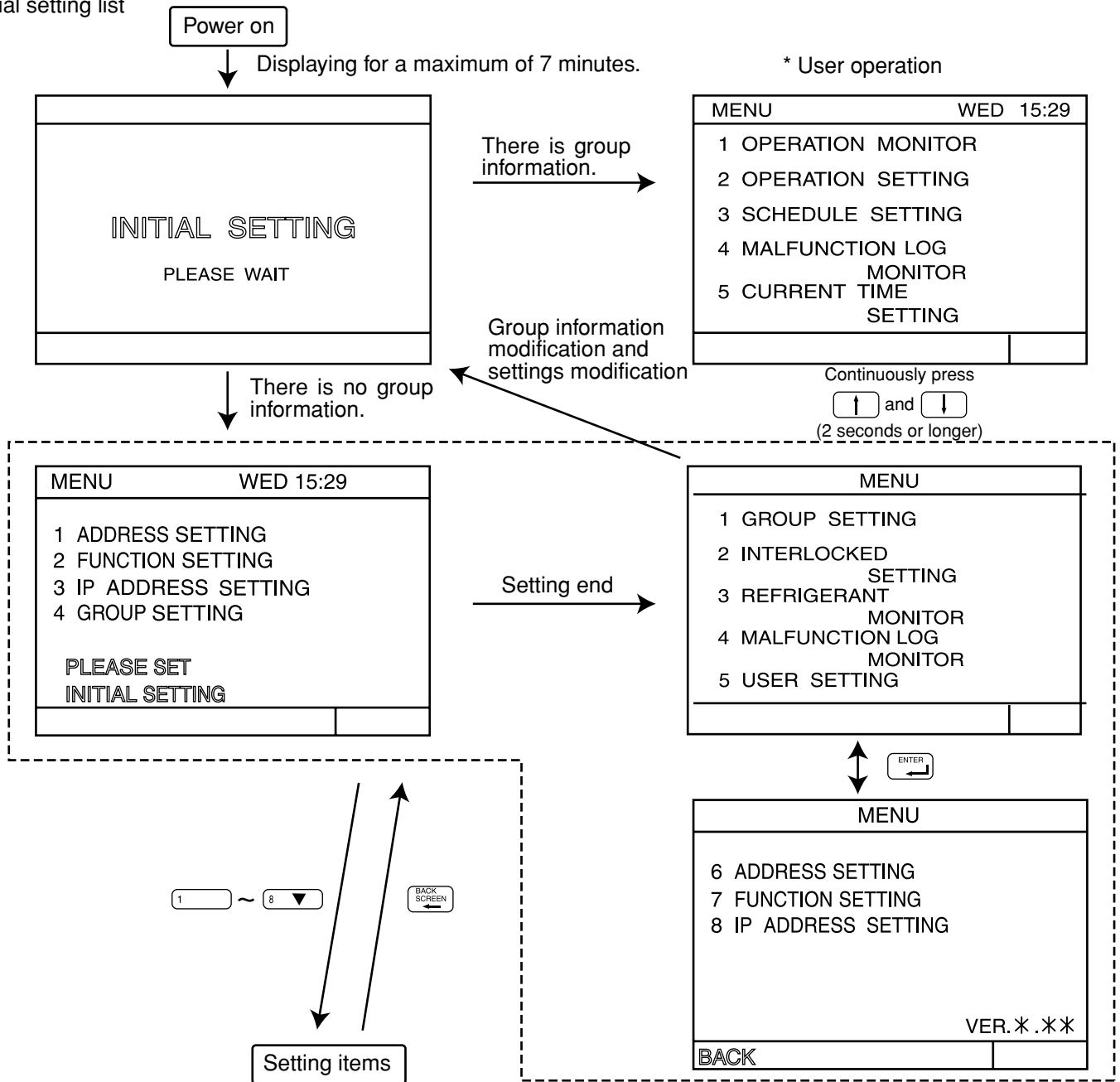

Menu items screen

Group configuration setting

GROUP SETTING	
G01	
ADDRESS	
UNIT	
REMOTE CONTROLLER	
SYSTEM CONTROLLER	
GROUP NAME SET	



GROUP NAME	
G01 M	
← ← ← ← ← → → → → →	
1 2 3 4 5 6 7 8 9 0 -	
A B C D E F G H I J K L M	
N O P Q R S T U V W X Y Z	
M MR	

Group name display area

... This performs the same group setting.

- ◀ GROUP SELECT ▶ : Select the group number.
- ← → ↑ ↓ : Move the cursor to address display position.
- Numeric keypad : Set the address.

(indoor unit, local remote controller, sub system controller)

- ← → ↑ ↓ : Move the cursor to the desired character.
- ENTER : Select the character.
- DEL : Delete the character.

Interlocked setting

INTERLOCKED SETTING	
INTERLOCKED UNIT ADDRESS	005
UNIT ADDRESS	<input type="text"/>

... Registration of interlocked operation of ventilation unit with single or multiple indoor unit is performed.

- : Select the address number of the interlocked OA processor unit or LOSSNAY.
- : Move the cursor to address display position.
- Numeric keypad : Set the address of the indoor unit.

User setting

USER SETTING	
1 OPERATION MONITOR	GROUP NO./NAME
	/UNIT ADDRESS
2 SCHEDULE DATA	SET. BACK/SET TEMP
	/NONE
3 FILTER SIGN	NONE/INDICATE
4 GROUP NO. DISPLAY	NONE/INDICATE
5 2001-1-1/	12001
6 ROOM TEMPERATURE	NONE/INDICATE
7 TEMP. UNIT	C/°F

... Select the display method and timer settings.

- : Select the items.

Refrigerant monitor

REFRIGERANT MONITOR	
OUTDOOR ADDRESS	51
BC/OS ADDRESS	52
UNIT ADDRESS	
01 02 03 04 05 06 07	
08 09 10 11 12 13 14	
15 16	

... The unit address are displayed for each refrigerant system.

- : Change the displayed refrigerant system.

Malfunction log

MALFUNCTION LOG	
PAGE 01/01	
18-04-2002	19:01
001-6607	(DETECT 000)
16-04-2002	12:45
014-6602	(DETECT 014)
12-04-2002	03:23
003-6607	(DETECT 000)
15-04-2002	09:12
112-6607	(DETECT 012)
01-04-2002	23:56
001-6607	(DETECT 000)

... The function allows monitoring of a log of the last 64 malfunction.

- : Changing pages.
- : Clear the malfunction log.

M-NET address setting

ADDRESS SETTING	
M-NET ADDRESS:	000

... Displays, or sets, the controller M-NET address.

- Numeric keypad: Set the controller address. (000, 201~250)

*Initial value is 000.

Function setting

FUNCTION SETTING	
ON	1 2 3 4 5 6 7 8
OFF	<input type="checkbox"/> <input type="checkbox"/> <input type="checkbox"/> <input type="checkbox"/> <input type="checkbox"/> <input type="checkbox"/> <input type="checkbox"/> <input type="checkbox"/>

... Sets the function of the controller.

- Numeric keypad: Set ON/OFF.
- : Move the cursor. : Active

(When No.3 is set to ON, the KA address input field is displayed.)
 (Numeric keypad: Set the address of the K transmission converter.)

IP address setting

IP ADDRESS SETTING	
IP ADDRESS :	192.168.001.001
SUBNET MASK :	255.255.255.000

... Sets the LAN IP address.

*Setting is unnecessary when a LAN is used.

- : Move the cursor to the address setting position.
- Numeric keypad : Set the address (0 ~ 255).

Appendix 2: User operation (abridged)

Shows the operation panel, screen, etc. for user operation.

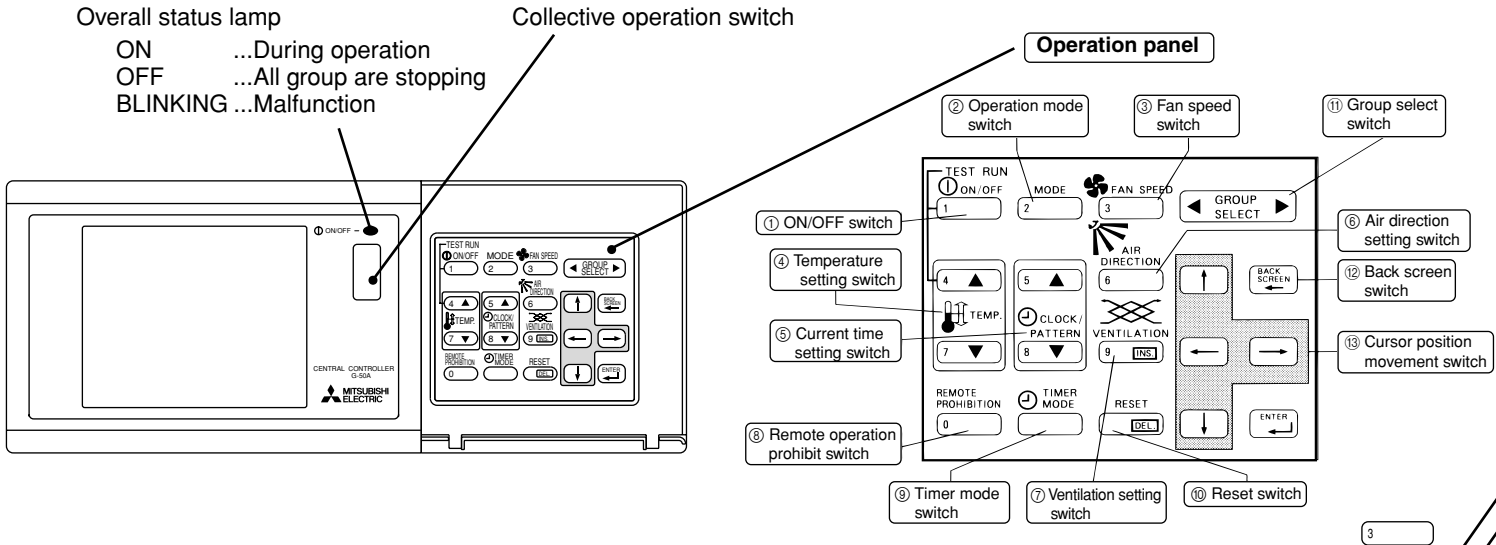

Initial setting menu
 * To initial setting

Continuously press and (2 seconds or longer)

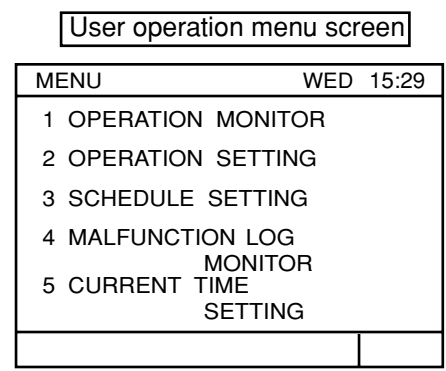

Operation setting screen

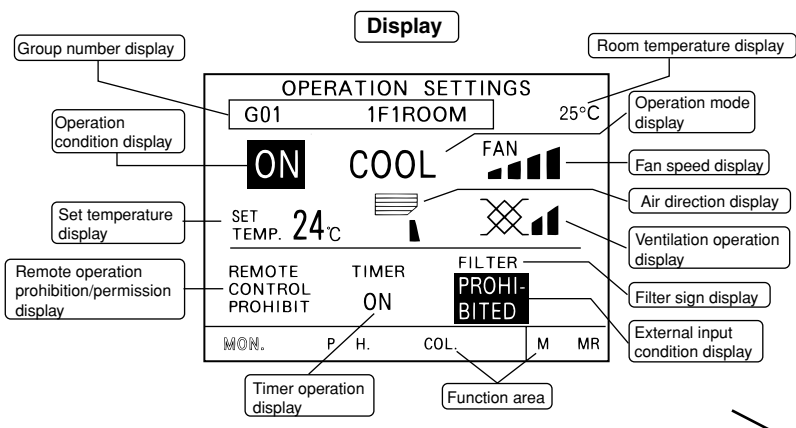

- * The following setting are possible using the Operation Panel switches
- Start/Stop, mode, set temperature, etc.
- Local remote control operation prohibition setting

Function area
 MON. : MONITOR
 PROH. : PROHIBIT
 COL. : COLLECTIVE
 M. : MEMORY
 MR. : MEMORY READ

Reverse: ON Normal: OFF
 Blinking: Malfunction during unit off
 Blinking and Reverse: Malfunction during unit is on

<Unit address display>

- GROUP SELECT : Change the display group
- : Turn all the units in that group ON or OFF

<Group number display, Group name display>

- : move the "▷" symbol.
- : Set the displayed group unit in indicated by the "▷" symbol to the ON/OFF mode.

Blinking "MON." +

Operation monitor screen

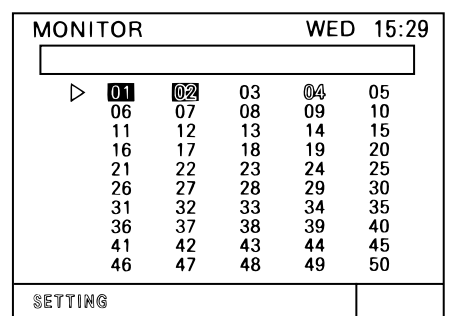

<Group number display>

Weekly schedule setting screen

SCHEDULE WED 15:29

G01 1F1ROOM

SU	MO	TU	WE	TH	FR	SA
-	1	1	2	1	1	3

0 12 24

P 1

P 2

P 3

P 4

M MR

- **GROUP SELECT** : Change the display group.
- **←** **→** **↑** **↓** : Move the cursor to the pattern position.
- **CLOCK / PATTERN** : Select P1 to P4 or (-)
- **5 ▲** / **8 ▼**
- **ENTER** : Complete the setting.

* Repeat assign the schedule pattern to each day (and each group)

NOTE: When the No.4 function select is set ON, P4 cannot be set.

* **P1** to **P3** of a composite pattern composed of P1 to P3 and P4.

BACK SCREEN

P1 ~ P4
+ ENTER

BACK SCREEN

SCHEDULE WED 15:29

G01 1F1ROOM

SU	MO	TU	WE	TH	FR	SA
-	1	1	2	1	1	3

P 1 ON OFF

24°C 0°C 0°C 0°C

- **←** **→** **↑** **↓** : Move the cursor position.
- **CLOCK / PATTERN** : Select the ON (PROHIBITION) time or OFF (PERMISSION) time. (Time is changed by 10 minutes unit.)
- **5 ▲** / **8 ▼**
- **ENTER** : Complete the setting. The cursor moves to the next setting position.

* Repeat set schedules.

* Three types (P1-P3) of daily ON/OFF pattern and one type (P4) of prohibition/permission pattern are available respectively, each of which can be set for each group.

Schedule pattern setting screen

Malfunction monitor screen

MALFUNCTION MON. WED 15:29

ERROR CODE PAGE 01/01

001-6607 (DETECT 000)

002-6607 (DETECT 000)

003-6607 (DETECT 000)

- **←** **→** **↑** **↓** : Change the pages
- **→** or **↑** = page +1
- **←** or **↓** = page -1
- **RESET DEL** : Reset all malfunctions

The unit address where the malfunction occurred

The unit address where the malfunction was detected

Error code

NOTE: When there is no malfunction taking place, [NO ERROR] lights up instead of [ERROR CODE].
When operation of the G-50A is prohibited, reset operation is invalid.

Current time setting screen

CURRENT TIME SETTING

22-09-2002 SUN 00:00

(DAY-MONTH-YEAR)

SETTING

- **←** **→** : Move the cursor position
- **5 ▲** **8 ▼** : Set the number or day
- * Set the date day, month, year and time.
- **ENTER** : Press this switch, where all setting have been completed.
- * The clock count will start with the second reset to 0.

BACK SCREEN

This product is designed and intended for use in the residential,
commercial and light -industrial environment.

The product at hand is
based on the following
EU regulations:

- Low Voltage Directive 73/23/EEC
- Electromagnetic Compatibility Directive 89/336/EEC

NOTE:

This equipment has been tested and found to comply with the limits for a Class B digital device, pursuant to Part 15 of the FCC Rules. These limits are designed to provide reasonable protection against harmful interference in a residential installation. This equipment generates, uses and can radiate radio frequency energy and, if not installed and used in accordance with the instructions, may cause harmful interference to radio communications.

However, there is no guarantee that interference will not occur in a particular installation.

If this equipment does cause harmful interference to radio or television reception, which can be determined by turning the equipment off and on, the user is encouraged to try to correct the interference by one or more of the following measures:

- Reorient or relocate the receiving antenna.
- Increase the separation between the equipment and receiver.
- Connect the equipment into an outlet on a circuit different from that to which the receiver is connected.
- Consult the dealer or an experienced radio / TV technician for help.