

# Air-Conditioners

**PLA-RP·AA / PUHZ-RP·HA**

**PU (H)-P·GAA**

## **OPERATION MANUAL**

For safe and correct use, please read this operation manual thoroughly before operating the air-conditioner unit.

**FOR USER**

## **操作说明书**

在操作空调机之前，请全面阅读本操作说明书，以便安全和正确地使用本机。

**用户适用 (安装人员适用)**

**English**

**中文**

# Contents

1. Safety Precautions .....	2
2. Operation .....	3
3. Care and cleaning .....	5
4. Troubleshooting .....	6
5. Specifications .....	7

## 1. Safety Precautions

- ▶ Before installing the unit, make sure you read all the “Safety precautions”.
- ▶ The “Safety precautions” provide very important points regarding safety. Make sure you follow them.
- ▶ Please report to or take consent by the supply authority before connection to the system.

### Symbols used in the text









 **Warning:**

Describes precautions that should be observed to prevent danger of injury or death to the user.

 **Caution:**

Describes precautions that should be observed to prevent damage to the unit.

### Symbols used in the illustrations

-  : Indicates an action that must be avoided.
-  : Indicates that important instructions must be followed.
-  : Indicates a part which must be grounded.
-  : Indicates that caution should be taken with rotating parts.
-  : Indicates that the main switch must be turned off before servicing.
-  : Beware of electric shock.
-  : Beware of hot surface.
-  **ELV** : At servicing, please shut down the power supply for both of Indoor Unit and Outdoor Unit.

 **Warning:**

Carefully read the labels affixed to the main unit.

 **Warning:**

- The unit should not be installed by the user. Ask the dealer or an authorized company to install the unit. If the unit is installed improperly, water leakage, electric shock or fire may result.
- Do not stand on, or place any items on the unit.
- Do not splash water over the unit and do not touch the unit with wet hands. An electric shock may result.
- Do not spray combustible gas close to the unit. Fire may result.
- Do not place a gas heater or any other open-flame appliance where it will be exposed to the air discharged from the unit. Incomplete combustion may result.
- Do not remove the front panel or the fan guard from the outdoor unit when it is running.
- When you notice exceptionally abnormal noise or vibration, stop operation, turn off the power switch, and contact your dealer.
- Never insert fingers, sticks etc. into the intakes or outlets.
- If you detect odd smells, stop using the unit, turn off the power switch and consult your dealer. Otherwise, a breakdown, electric shock or fire may result.
- This air conditioner is NOT intended for use by children or infirm persons without supervision.
- Young children should be supervised to ensure that they do not play with the air conditioner.
- If the refrigeration gas blows out or leaks, stop the operation of the air conditioner, thoroughly ventilate the room, and contact your dealer.

 **Caution:**

- Do not use any sharp object to push the buttons, as this may damage the remote controller.
- Never block or cover the indoor or outdoor unit's intakes or outlets.

### Disposing of the unit

When you need to dispose of the unit, consult your dealer.

## 2. Operation

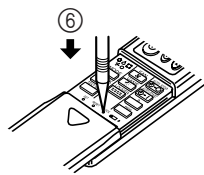
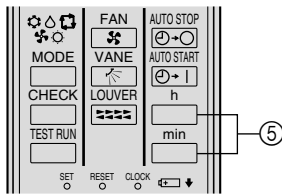
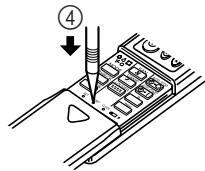
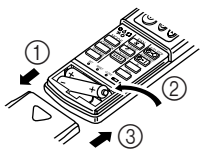

### Replacing the Batteries and how to set the current time

If no signal is transmitted and the indoor unit's lamp does not light up even if the remote controller is operated, the batteries may have run out, so replace them with new ones as described below.

- ① Remove the front lid.
- ② Replace the batteries with alkali batteries (size AAA). Make sure that the batteries are installed in the correct direction. (Insert the minus pole of the batteries first.)
- ③ Reattach the front lid.
- ④ Press the RESET button using a thin stick.
- ⑤ Press the  and  button to set the current time.
- ⑥ Press the CLOCK button using a thin stick and close the front lid.

If you are not going to use the unit for a long period of time, remove the batteries to prevent damage which may occur due to leakage of electrolyte.

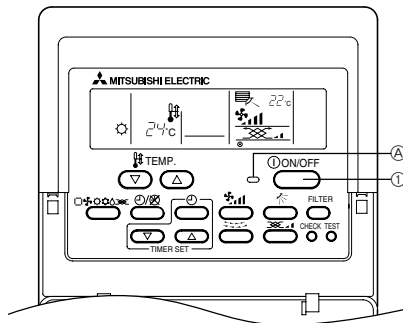
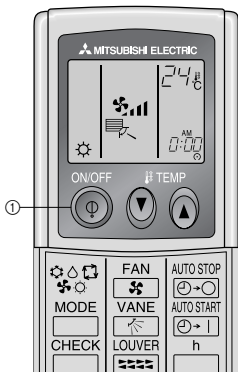

Check if your remote controller is the wired type or the wireless type before referring to the illustration and text for operation procedures.

### 2.1. Switching the unit on/off

The power supply should not be turned off while the air conditioner is in use. This can cause the unit to break down.

- ① Press the ON/OFF button.
  - (A) The ON indicator should light up.
- Even if you press the ON/OFF button immediately after shutting down the operation in progress, the air conditioner will not start for about three minutes. This is to prevent the internal components from being damaged.
- If the operation stops due to a power failure, the unit will not automatically restart until the power has been restored. Press the ON/OFF button to restart.

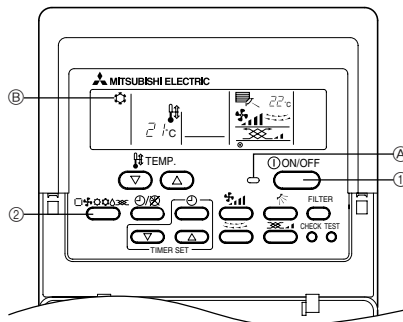
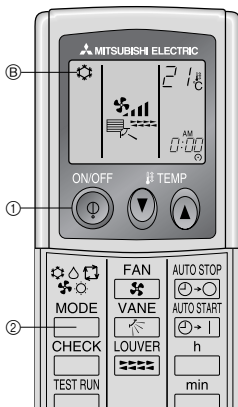

### 2.2. Mode select

- ① If the unit is off, press the ON/OFF button to turn it on.
  - (A) The ON indicator should light up.
- ② Press the operation mode () button and select the operation mode.
  - (B)
    - Cooling mode
    - Fan mode
    - Heating mode
    - Drying mode
    - Automatic (cooling/heating) mode

#### Note:

The heating display and the automatic display does not appear in models that operate exclusively as cooling only air-conditioner.

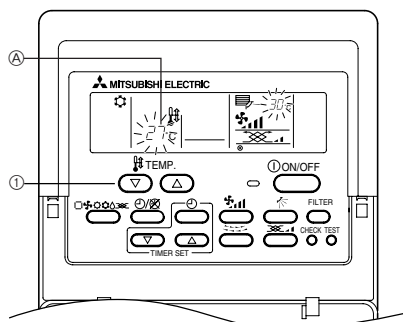
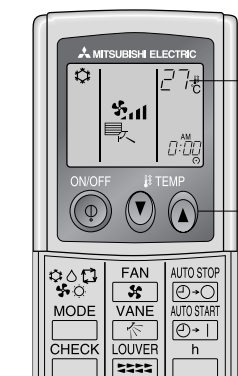

### 2.3. Selecting a temperature TEMP.

#### ► To decrease the room temperature:

- ① Press  button to set the desired temperature.
  - (A) The selected temperature is displayed.
- Each time you press the button, the temperature value decreases by 1 °C.

#### ► To increase the room temperature:

- ① Press  button to set the desired temperature.
  - (A) The selected temperature is displayed.
- Each time you press the button, the temperature value increases by 1 °C.

• Available temperature ranges are as follows:

- Cooling & Drying: 19 - 30 °C
- Heating: 17 - 28 °C
- Automatic: 19 - 28 °C
- Circulation: — (Not available)

• The display flashes either 8 °C - 39 °C to inform you if the room temperature is lower or higher than the displayed temperature.

## 2. Operation

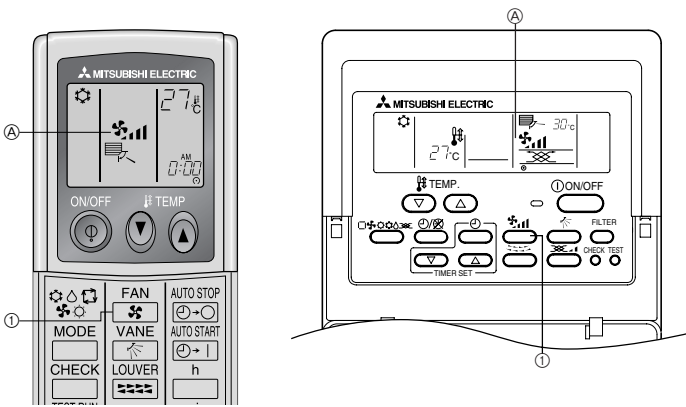

### 2.4. Selecting a fan speed

- Press the fan speed button to select a desired fan speed.
- Each time you press the button, available options change with the display (A) on the remote controller, as shown below.

Fan speed	Remote controller display			
	Low	Middle 2	Middle 1	High
4-stage				

The display and the fan speed of the unit will differ in the following situations:

- When STAND BY and DEFROST are displayed.
- Just after the heating mode (while waiting to change to another mode).
- When the temperature of the room is higher than the temperature setting of the unit operating in the heating mode.
- In the dry operation, the indoor fan automatically turns to low-speed operation. Switching of fan speed is impossible.

### 2.5. Adjusting vertical airflow direction

■ Except for PSA/PSH series

The vertical air vane helps select the vertical direction of the airflow.

- Press the vertical airflow direction button to select the vertical airflow direction.
- Each time you press the button, the option changes are displayed on the remote controller, as shown below.

(A) (swing) → (B) → (C) → (D) → (E) → (A)

- If the room temperature is higher than the temperature set on the remote controller while the unit is defrosting or preparing for heating, the vertical air vane will move to the horizontal airflow position (B).
- In either cooling or dry mode, if you select (C), (D) or (E) when the fan speed is low, middle 2, a display reading "1 Hr" (F) will appear. After one hour, the air conditioner will switch automatically to horizontal air mode (B) and the display "1 Hr" (F) will disappear.
- When the heating thermostat is OFF, the louver automatically turns horizontally during defrosting or preparation for heating.

### 2.6. Using the timer

#### 1) Set the current time

- Press the CLOCK button to display the "CLOCK" (B).

Remote controller display (A)	CLOCK → ON → OFF → No Display

- Each time you press the up/down button, the time increases/decreases in increments of one minute. Each time you press the up/down button, the time increases/decreases in increments of one minute.
- Press and hold the button to rapidly change the time.
- The time changes in increments of one minute → ten minutes → in units of hour; in this order.
- Approximately ten seconds after pressing the button, the display on the remote controller will turn off.

The example shows a timer set for operation start at 8:00 and end at 17:00.

#### 2) Set the mode to continuous as follows

- Press the continuous mode button to display (D).

#### 3) Set the time to start the unit as follows

- Press the start time button to display (B).
- Press the timer set button to set the time that you want the unit to start. The start time is displayed at (A).

#### 4) Set the time to stop the unit as follows

- Press the stop time button to display (C).
- Press the timer set button to set the time that you want the unit to stop. The stop time is displayed at (A).

#### 5) Set the mode to timer as follows

- Press the timer mode button to display (D).

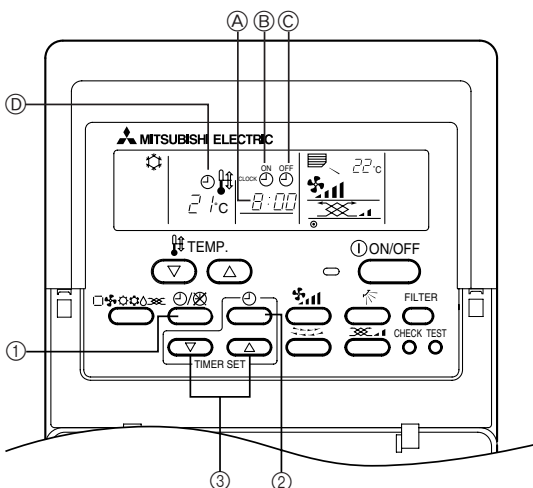
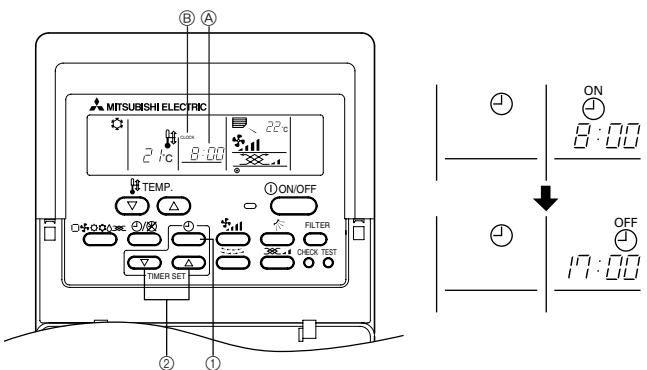
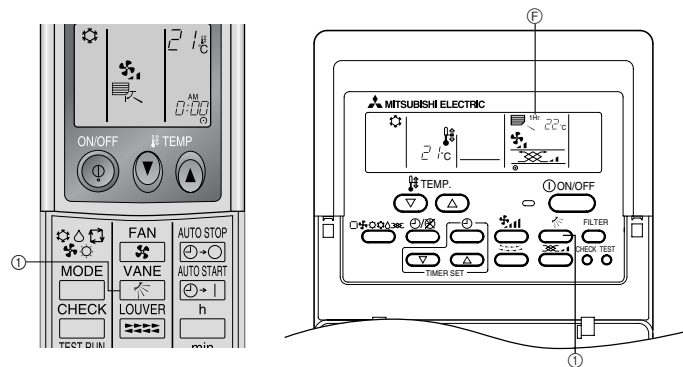
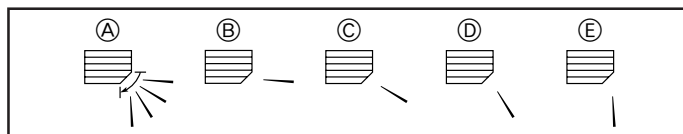

## 2. Operation

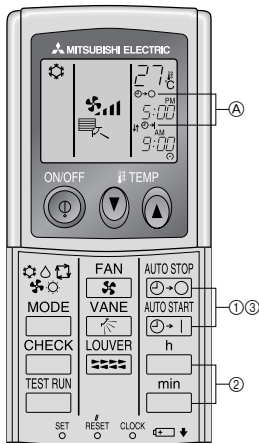

### For wireless remote controller

- ① Press the or button (TIMER SET).
- Time can be set while the following symbol is blinking.  
OFF timer : is blinking.  
ON timer : is blinking.
  - ② Use the and buttons to set the desired time.
  - ③ Canceling the timer.  
To cancel the OFF timer, press the button.  
To cancel the ON timer, press the button.
- It is possible to combine both OFF and ON timers.
  - Pressing the ① ON/OFF button of the remote controller during timer mode to stop the unit will cancel the timers.
  - If the current time has not been set, the timer operation cannot be used.

## 3. Care and cleaning

### 3.1. Cleaning the filters and the indoor unit

#### Cleaning the filters

- Clean the filters using a vacuum cleaner. If you do not have a vacuum cleaner, tap the filters against a solid object to knock off dirt and dust.
- If the filters are especially dirty, wash them in lukewarm water. Take care to rinse off any detergent thoroughly and allow the filters to dry completely before putting them back into the unit.

#### ⚠ Caution:

- Do not dry the filters in direct sunlight or by using a heat source, such as an electric heater: this may warp them.
- Do not wash the filters in hot water (above 50°C), as this may warp them.
- Make sure that the air filters are always installed. Operating the unit without air filters can cause malfunction.

#### ⚠ Caution:

- Before you start cleaning, stop operation and turn OFF the power supply.
- Indoor units are equipped with filters to remove the dust of sucked-in air. Clean the filters using the methods shown in the following sketches.

#### ■ PLA-RP-AA

- ① Pull the knob on the intake grille in the direction indicated by the arrow and it should open.
- ② Open the intake grille.
- ③ Release the knob on the center edge of the intake grille and pull the filter forward to remove the filter.

Ⓐ Knob    Ⓑ Grille    Ⓒ Intake grille    Ⓓ Filter

### 3.2. Care and cleaning

#### Clean the filter

When the Ⓐ “FILTER” indicator blinks on the remote controller to alert you to the necessity of cleaning of the filter.

\* As a guideline for typical office environment, the long-life filter must be cleaned every 2,500 operating hours.

#### Reset the FILTER indicator

- ① Press the FILTER button twice after cleaning.
- ▶ When you press the FILTER button twice, the “FILTER” indicator Ⓐ will be turned off and reset.
  - ▶ The FILTER indicator provides you with a guideline for the necessity of filter cleaning based on total operating hours in typical indoor air conditions. Depending on different operating environments, more or less frequent cleaning may be necessary.

#### ■ PLA-RP-AA

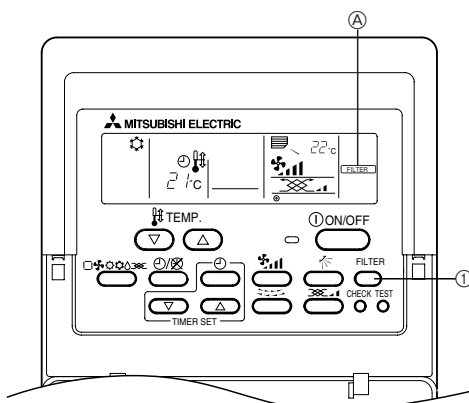
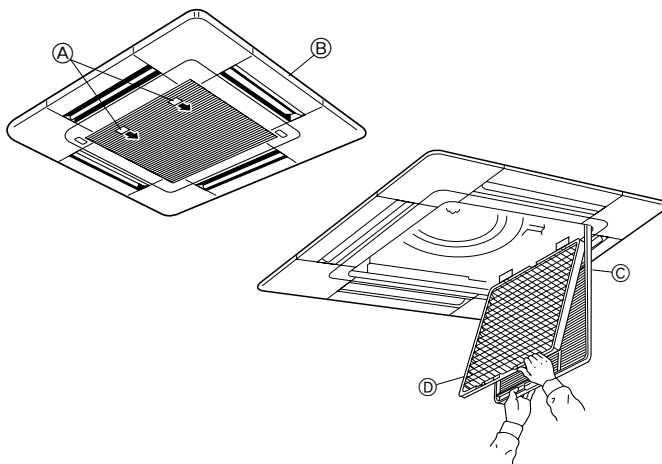

## 4. Troubleshooting

Before you call out a repair man, check the following table to see whether there is a simple solution to your problem.

### [for wireless remote controller]

Problem	Solution	Problem	Solution
Unit does not operate at all.	Turn main power on. Then press the POWER ON/OFF button to turn the unit on. Wait until power is restored, then press the POWER ON/OFF button to turn the unit on.	Unit does not start immediately.	Wait until the unit restarts automatically. The compressor may hesitate resuming because a three-minute resume prevention circuit is incorporated in the outdoor unit for protection of the compressor.

### [for wired remote controller]

Problem	Solution	Problem	Solution
Unit does not cool or heat very well.	Clean the filter.	CENTRALLY CONTROLLED is displayed in the remote controller.	The start and stop functions of the remote controller are not available when the CENTRALLY CONTROLLED message is lit.
The unit stops operating before arriving at the set temperature in the heating mode.	Frost forms when the outdoor temperature is low and humidity is high. Wait for about 10 minutes for the frost to melt.	The start and stop functions are not available just after restarting the unit.	Wait about three minutes (operation has stopped to prevent damage to the air conditioner).
The airflow direction suddenly changes.	After one hour of cooling-mode operation with the airflow in a downward direction, the unit will automatically change to the "Horizontal airflow" mode. When the unit is in the heating or defrosting mode, it will automatically change to the "Horizontal airflow mode".	"H0" is displayed in the remote controller.	An automatic startup test is being performed (will last for about two minutes).
A white mist is expelled from the indoor unit.	This may occur just after the unit is turned on when a high level of humidity is present in the room.	An error code is displayed in the remote controller. The operating display of the wireless remote controller's receiver is flashing.	A self-diagnostic function is being performed to preserve the air conditioner. * Do not attempt to make repairs yourself. Turn the main switch off and contact the dealer from whom you bought the air conditioner. Provide him or her with the name of the unit and the information displayed in the remote controller.
The indicators of the remote controller do not light up when operated.	Turn on the power switch. ". " will be displayed.		

**NOTE:** After a power cut, the unit will not restart automatically. You will have to restart it by pressing the POWER - ON/OFF button on the remote controller.

If none of the above apply, turn the main switch off and contact the dealer from whom you bought the air-conditioner, telling him the model name and the nature of the problem. Do not try to fix the unit yourself.

### In any of the following cases, turn off the main power switch and contact your local dealer for service:

- The operation lamp (on the main unit) flashes.
- The switches do not work properly.
- The circuit breaker trips frequently (or the fuse blows frequently).
- Water has accidentally been splashed into the unit.
- Water leaks from the unit.
- Something is accidentally dropped into the air-conditioner.
- An unusual noise is heard during operation.

### Operating range

		Indoor air intake temperature	Outdoor air intake temperature
Cooling	Maximum	35 °C DB, 22.5 °C WB	46 °C DB
	Minimum	19 °C DB, 15 °C WB	-5 °C DB
Heating	Maximum	28 °C DB	21 °C DB, 15 °C WB
	Minimum	17 °C DB	-11 °C DB, -12 °C WB

### The following do not indicate any malfunction:

Odours: smells such as tobacco or cosmetic odours may persist after they have been sucked into the unit.

Sound of liquid flowing inside indoor unit: this can occur during or after operation and is simply the sound of refrigerant being circulated inside the unit.

Ticking sound coming from indoor unit: this can occur when cooling or heating has just begun or has just stopped. It is caused by the indoor unit shrinking or expanding slightly due to the change in temperature.

The message "CENTRALLY CONTROLLED" appearing on the LCD panel: from time to time, this message may come up on the LCD panel. This does not indicate any malfunction.

### Remote Controller Settings for Installing/Replacing Batteries and Restarting Operation (for wireless remote controller)

- Always press the reset button after installing or replacing batteries.
- The initial settings are used when installing or replacing batteries after which the settings for restarting are used.

	Initial Settings	Restarting	
Operating mode	Fan	Previous operating mode	
Temperature setting	—	Previous temperature setting	
Fan speed	High	Previous fan speed setting	
Airflow direction	Level	Operating mode	Level
		Cooling - Dry	Level
		Heating	Previous setting
		Fan	Level

**NOTE:** The refrigerant charged in the air conditioner is safe. Refrigerant normally does not leak, however, if refrigerant gas leaks indoors, and comes into contact with the fire of a fan heater, space heater, stove, etc., harmful substances will be generated.

Be sure to ask the service representative whether there is refrigerant leakage or not when repairs are carried out.

## 5. Specifications

### ■ PLA-RP-AA+PU(H)-P-GAA

Model	RP1.6	RP2	RP2.5	RP3	RP4	RP5	RP6
Capacity (Cooling/Heating) <kW> *1	4.50/4.95	5.60/6.35	6.70/7.30	7.70/9.20	9.60/10.50	13.30/15.60	14.20/17.00
Total Input (Cooling/Heating) <kW> *1	1.72/1.70	2.53/2.20	2.57/2.40	3.42/3.48	3.68/3.91	5.09/5.54	5.90/6.35
Power source (voltage <V>/Frequency <Hz>)	-						
Dimension (Height) <mm> *2	258 (30)				298 (30)		
Dimension (Width) <mm> *2	840 (950)						
Dimension (Depth) <mm> *2	840 (950)						
Fan Airflow rate (Low-Middle2-Middle1-High) <m <sup>3</sup> /min>	11-12-13-14	14-15-16-18		15-16-18-20	20-23-26-28	22-25-28-30	
Noise level (Low-Middle2-Middle1-High) <dB>	27-28-29-31	28-29-31-33		28-30-32-34	33-36-39-41	37-40-43-45	
Net weight <kg> *2	24 (5)				30 (5)	32 (5)	

### ■ PU(H)-P-GAA

Model	P1.6V P1.6Y	P2V P2Y	P2.5V P2.5Y	P3V P3Y	P4V P4Y	P5Y	P6Y
Power source (voltage <V>/Frequency <Hz>)	V:~N220-230-240/50, Y:3N-380-400-415/50						
Dimension (Height) <mm>	650	855			1260		
Dimension (Width) <mm>	900					1050	
Dimension (Depth) <mm>	330+20						
Fan Airflow rate <m <sup>3</sup> /min>	45	55	50	85	95	100	
Net weight <kg>	54	74	79	97	112	113	

### ■ PLA-RP-AA+PUHZ-RP-VHA

Model	RP1.6	RP2	RP2.5	RP3	RP4	RP5	RP6
Capacity (Cooling/Heating) <kW> *1	3.60/4.10	5.00/6.00	6.00/7.00	7.10/8.00	10.00/11.20	12.50/14.00	14.00/16.00
Total Input (Cooling/Heating) <kW> *1	1.07/1.12	1.55/1.62	1.65/1.85	1.97/2.34	3.03/3.39	3.89/4.27	4.99/4.91
Power source (voltage <V>/Frequency <Hz>)	-						
Dimension (Height) <mm> *2	258 (30)				298 (30)		
Dimension (Width) <mm> *2	840 (950)						
Dimension (Depth) <mm> *2	840 (950)						
Fan Airflow rate (Low-Middle2-Middle1-High) <m <sup>3</sup> /min>	11-12-13-14	14-15-16-18		15-16-18-20	20-23-26-28	22-25-28-30	
Noise level (Low-Middle2-Middle1-High) <dB>	27-28-29-31	28-29-31-33		28-30-32-34	33-36-39-41	37-40-43-45	
Net weight <kg> *2	24 (5)				30 (5)	32 (5)	

### ■ PUHZ-RP-VHA

Model	RP1.6V	RP2V	RP2.5V	RP3V	RP4V	RP5V	RP6V
Power source (voltage <V>/Frequency <Hz>)	V:~N 220-230-240/50						
Dimension (Height) <mm>	600	943			1350		
Dimension (Width) <mm>	800	950					
Dimension (Depth) <mm>	300+15		330+30				
Fan Airflow rate <m <sup>3</sup> /min>	35		55		100		
Net weight <kg>	45		69		113		

\*1 Cooling: Indoor 27 °C DB/19 °C WB, Outdoor 35 °C DB  
 Heating: Indoor 20 °C DB, Outdoor 7 °C DB/6 °C WB

\*2 This figure in ( ) indicates panel's.



# 目录

1. 安全注意事项 .....	8
2. 操作 .....	9
3. 保养和清洁 .....	11
4. 故障检修 .....	12
5. 规格 .....	13

## 1. 安全注意事项

- ▶ 在安装设备之前，确定您已阅读了所有的“安全注意事项”。
- ▶ “安全注意事项”提供了非常重要的有关安全的要点。请您确保按其执行操作。
- ▶ 在连接到系统上之前，请向供电管理局报告或得到其许可。

### 文中使用的符号

#### ⚠ 警告:

描述了应该遵守的注意事项，以防止对用户造成伤害或死亡的危险。

#### ⚠ 注意:

说明为了防止本机损坏而应该遵循的注意事项。

### 列举说明中使用的符号

- ⊘ : 指示必须避免的行为。
- ❗ : 指示必须遵循该重要说明。
- ⚡ : 指示一个必须接地的零件。
- ⚠ : 指示操作旋转部分时必须小心。
- 🔌 : 指出在维修之前必须关闭主开关。
- ⚠ : 小心电击。
- ⚠ : 小心烫的表面。
- 🔌 ELV : 在维修时，请同时关闭用于室内机组和室外机组的电力供应。

#### ⚠ 警告:

请非常仔细地阅读贴在主机上的标签。

#### ⚠ 警告:

- 本机不得由用户安装，请代经销商或者一家经三菱授权的公司安装本机。如果本机安装不当，则可能引起漏水、触电或者火灾。
- 切勿站立在本机上或者将任何物品放置在本机上。
- 切勿使水溅在本机上并且不得用湿手碰触本机，否则可能引起触电。
- 切勿在本机附近喷射可燃气体，否则可能引起火灾。
- 切勿将煤气加热器或者任何其它有焰装置放置在暴露于本机排放气体之处，否则会引起不完全燃烧。
- 当室外机组运行时，切勿拆卸其前面板或者风扇罩。
- 当察觉有异常噪音或振荡出现时，请立即停止使用机组，关上电源和联络分销商。
- 切勿将手指或木条等物品插入入气口或出气口中。
- 如嗅到异味，请立即停止机组运作，关上电源并与分销商联络。否则，可能引致机件损毁以及造成触电或火灾。
- 在没有指导监督的情况下，小孩或体弱之人不能使用本空调机。
- 小心看管小孩，以保证他们不会玩空调机。
- 如果发现致冷气体溢出或泄漏，请马上停止空调机操作，使室内空气彻底流通并联络分销商。

#### ⚠ 注意:

- 切勿使用任何尖锐物按动按钮，否则可能损坏遥控器。
- 切勿堵塞或者遮盖户内或者室外机组的进气口或者出气口。

### 本机的处置

当您需要处置本机时，应与您的代经销商联系。



## 2. 操作

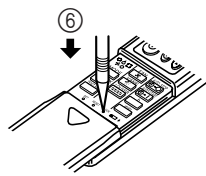
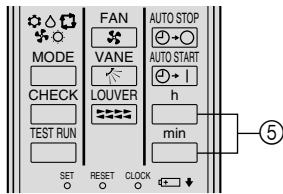
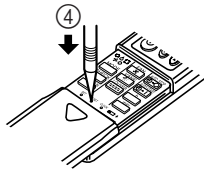
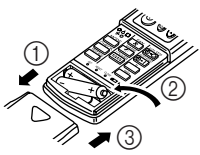

### 更换电池及设定当前时间

尽管正在操作遥控器，但是没有发送信号并且室内机组的灯没有点亮，则电池可能用尽，需要按照如下所述步骤更换一个新的电池。

- ① 卸下前盖。
- ② 用碱性电池（尺寸AAA）更换电池。确定以正确的方向安装电池。（首先插入电池的负极。）
- ③ 再装上前盖。
- ④ 使用一根幼细的竹条按复位按钮。
- ⑤ 按  $\text{h}$  和  $\text{min}$  按钮设定当前时间。
- ⑥ 使用一根幼细的竹条按CLOCK（时钟）按钮，然后关上前盖。

如果您准备在一段时间内不使用设备，则应取出电池，防止由于电池泄漏造成的损坏。

在参阅有关操作步骤的图和文字之前，请先检查您的遥控器是有线类型或者是无线类型。

### 2.1. 打开/关闭本机

• 不应在使用空调机时关闭电源，这样会导致机器故障。

- ① 按下ON/OFF按钮。

Ⓐ ON（打开）指示灯应该点亮。

• 即使您在停止运行之后立即按下ON/OFF（打开/关闭）按钮，空调机在大约三分鐘之内也不会启动，这样可以防止内部零件发生损坏。

• 如果由于停电停止操作，本机在恢复供电之后才会自动重新启动，按下ON/OFF（打开/关闭）按钮，可重新启动。

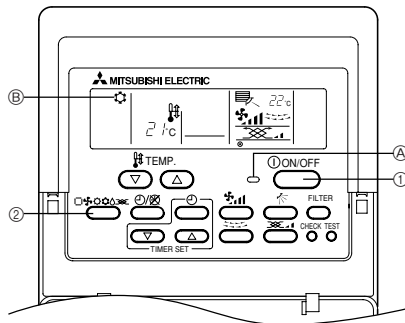
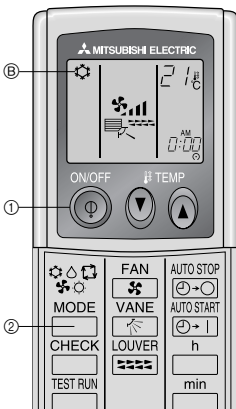
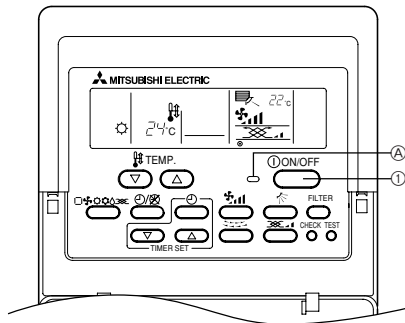
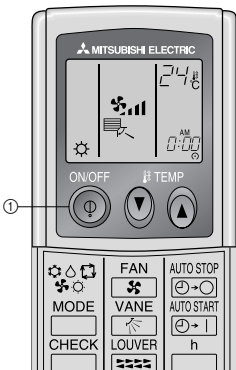

### 2.2. 模式选择

- ① 如果本机已关闭，则可按下ON/OFF（打开/关闭）按钮打开本机。

Ⓐ ON（打开）指示灯应该点亮。

- ② 按操作模式（ $\square$   $\square$   $\square$   $\square$   $\square$ ）按钮，并且选择操作模式。

Ⓑ

- $\square$  制冷模式
- $\square$  送风模式
- $\square$  制热模式
- $\square$  除湿模式
- $\square$  自动（制冷/制热）模式

备注：

在只用于冷却的空调机型号上，不会出现加热显示和自动显示。

### 2.3. 选择温度 $\text{TEMP.}$

▶ 若要降低室温：

- ① 按下  $\nabla$  按钮，设定理想温度。

Ⓐ 显示选取的温度。

• 每次按下此按钮，温度值侧会减少 1 ℃。

▶ 若要增大室温：

- ① 按下  $\triangle$  按钮，设定理想温度。

Ⓐ 显示选取的温度。

• 每次按下此按钮，温度值侧会增加 1 ℃。

• 可提供下列温度范围：

冷却和干燥：	19 - 30 ℃
加热：	17 - 28 ℃
自动：	19 - 28 ℃
循环：	—（不提供）

• 闪烁显示 8 ℃-39 ℃，即通知您室温低于或高于显示的温度。

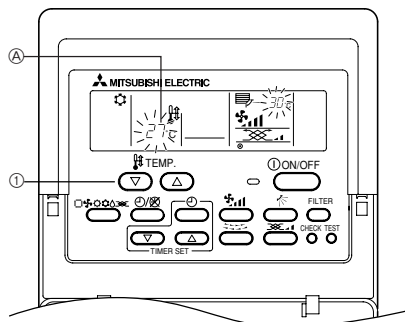
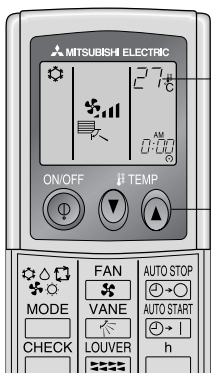

## 2. 操作

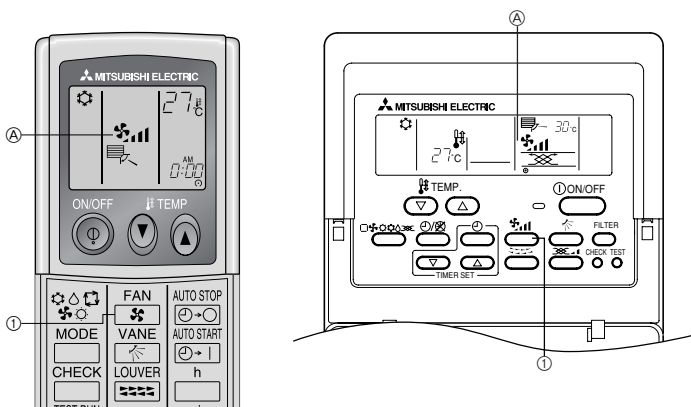

### 2.4. 选择风扇速度

- ① 按下 按钮，选择理想的风扇速度。
- 每次您按下此按钮，可提供的选项随著遥控器上的显示④发生变化，如下所示。

风扇速度	遥控器显示			
	低档	中档2	中档1	高档
4级				

在以下情况中，显示和设备的风扇速度将会不同：

- 当显示STAND BY (备用) 和DEFROST (除霜) 时。
- 在加热模式之后不久 (当等待改变到其他模式时)。
- 当室温比设备在加热模式下操作时设置的温度较高时。
- 在干燥模式操作时，室内风扇会自动转换至低速运行。不能切换风扇速度。

### 2.5. 调整纵向气流方向

■ PSA/PSH系列除外

纵向风向叶片有助选择气流纵向。

- ① 按下 按钮，选择纵向气流方向。
- 每次您按下此按钮，遥控器则会显示选项变化，如下所示。

(A) (摆动) → (B) → (C) → (D) → (E) → (A)

- 当机组正在除霜或准备加热时，如果室温高于在遥控器上设定的温度，垂直空气叶片便会移动至水平气流位置(B)。
- 在冷却或干燥模式下，当风扇速度处于低速、中速 2 时，如果您选择(C)、(D)或(E)，便会出现“1 Hr” (E) 的显示。在一个小时之后，空调器会自动切换至水平空气模式(B)，并且“1 Hr” (E) 的显示会消失。
- 当暖气恒温器被关闭，而机组处于解冻或准备暖气模式操作时，放气窗会自动变成左右吹风。

### 2.6. 使用定时器

#### 1) 设定当前时间

- ① 按下 按钮，显示“CLOCK” (B)。

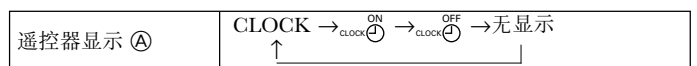

- ② 每次您按下 按钮时，时间按照 1 分钟的增量增加，每次按下 按钮，时间按照 1 分钟的增量减少。

- 按住此按钮，可迅速改变时间。
  - 时间依照一分钟 → 十分钟 → 单位小时的变量顺序变化。
  - 在按下此按钮之后大约十秒钟，遥控器上的显示器会关闭。
- 显示例中，定时器的开始时间为8:00而终止时间为17:00。

#### 2) 设置连续模式，机组运行如下。

- ① 按下 按钮，显示 (D) (E)。

#### 3) 依照下述步骤设定时间，启动本机

- ② 按下 按钮，显示 (B) (E)。
- ③ 按下 按钮，设定您想要启动本机的时间。  
启动时间显示在 (A) 上。

#### 4) 依照下述步骤设定时间，终止本机运行

- ② 按下 按钮，显示 (C) (E)。
- ③ 按下 按钮，设定您想要终止运行本机的时间。  
终止时间显示在 (A) 上。

#### 5) 设置定时器模式，机组运行如下。

- ① 按下 按钮，显示 (D) (E)。

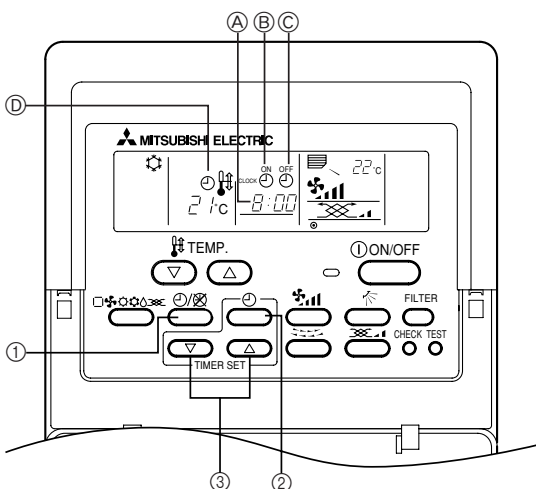
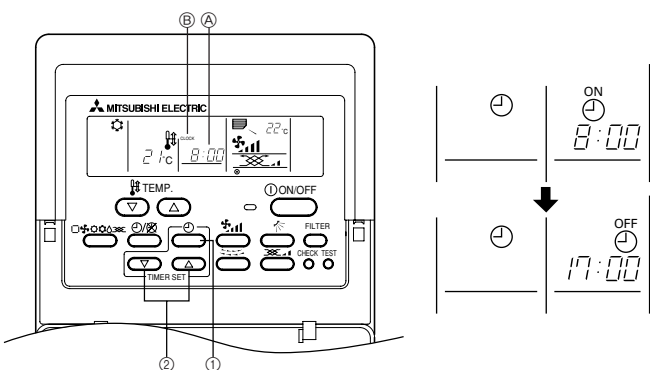
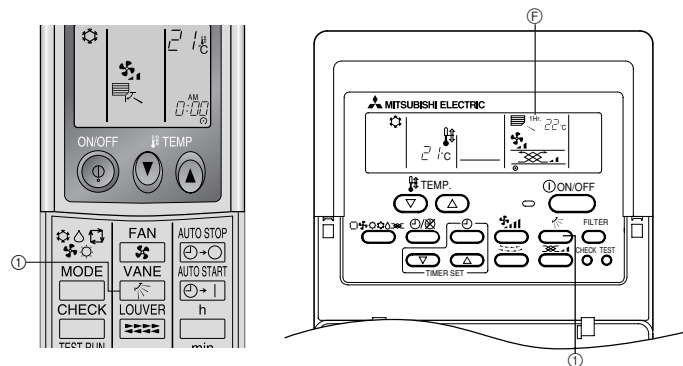
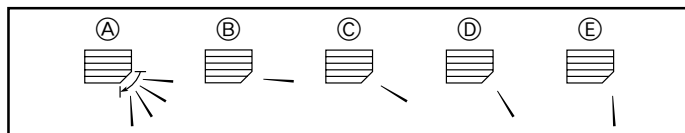

## 2. 操作

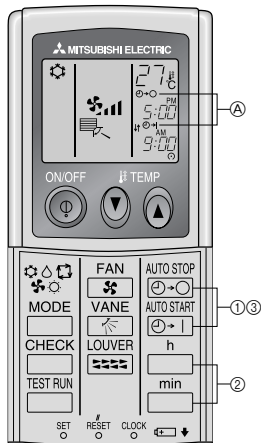

### 对于无线遥控器

- ① 按 或 按钮 (定时器设定)。
- 当如下符号闪烁时, 可以设定时间。  
OFF (关闭) 定时器: 闪烁。  
ON (打开) 定时器: 闪烁。
- ② 使用 和 按钮设定希望的时间。
- ③ 取消定时器。  
如果想取消OFF (关闭) 定时器, 按 按钮。  
如果想取消ON (打开) 定时器, 按 按钮。
- 可以结合使用OFF (关闭) 和ON (打开) 定时器。
- 在定时器模式中按遥控器的 ① ON/OFF (打开/关闭) 按钮停止设备, 可以取消定时器。
- 如果未设定当前时间, 将不能使用定时器操作。

## 3. 保养和清洁

### 3.1. 清洁滤清器和室内机组

#### 清洁滤清器

- 使用吸尘器清洁滤清器。如果您没有吸尘器, 则可對著一个坚硬体轻击滤清器, 将灰尘敲落。
- 如果滤清器特别肮脏, 则应使用微温水冲洗。应注意彻底擦除任何清洁剂, 并且在将滤清器重新放回本机内之前使滤清器完全凉干。

#### △ 注意:

- 切勿在直射的太阳光下晒干滤清器, 或者用一个热源如电炉烘干滤清器: 这样会使滤清器变形。
- 切勿用热水 (50℃ 以上) 清洗滤清器, 否则会使滤清器变形。
- 应确保始终安装空气滤清器。操作本机时, 若无空气滤清器, 则可能引起故障。

#### △ 注意:

- 清洗机件之前, 必须先停止操作以及将电源关掉。
- 室内机组内备有隔绝吸入空气尘埃用的过滤网。请依照下图表示方法, 清除过滤网上的污垢。

#### ■ PLA-RP-AA

- ① 依照箭头所示的方向, 拉动在进气格栅的捏手, 便应该可以将格栅打开。
  - ② 打开进气格栅。
  - ③ 松开进气格栅中央边缘的旋钮, 并且将过滤网向前推以卸下过滤网。
- A 捏手      B 格栅      C 进气格栅      D 滤清器

### 3.2. 保养和清洁

#### 清洁滤清器

当遥控器上的 A “FILTER” 指示灯发生闪烁时, 即提醒您有必要清洁滤清器。

\* 在典型的办公室环境下, 必须每隔 2,500 运行小时清洁长寿命滤清器一次。

#### 重设 FILTER 指示灯

- ① 在清洁之后按两次 FILTER (滤清器) 按钮。
- ▶ 当您按下两次 FILTER (滤清器) 按钮时, “FILTER (滤清器)” 指示灯 A 会关闭并且重设。
  - ▶ FILTER (滤清器) 指示灯依据典型室内空调状况下的总的运行小时, 为您提供需要清洁滤清器的警示, 根据不同的运行环境, 可能需要经常清洗, 周期或长或短。

#### ■ PLA-RP-AA

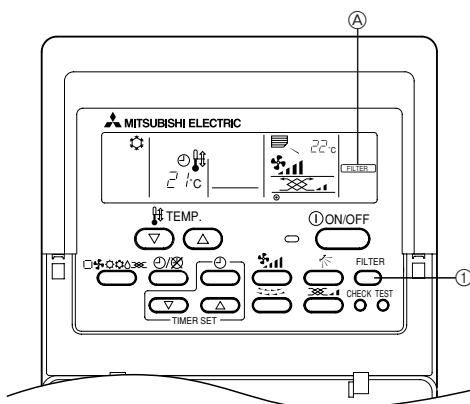
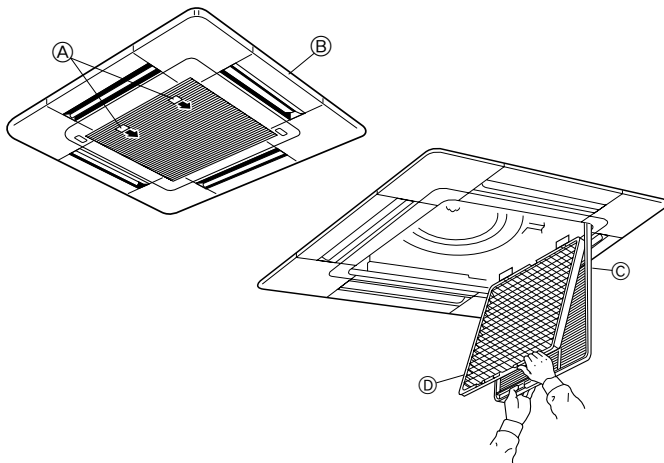

## 4. 故障检修

在您叫检修人员之前，可首先对照下表进行检查，看是否可以用简单的办法加以解决。

### [对于无线遥控器]

问题	解决措施	问题	解决措施
设备根本不能操作。	打开主电源，然后按下POWER ON/OFF（电源打开/关闭）按钮，打开本机。 等待重新来电，然后按下POWER ON/OFF（电源打开/关闭）按钮，打开本机。	机器不会立即启动。	等待本机自动地重新启动，压缩机可能会暂缓恢复，因为室外机组中装配了一个三分钟恢复防护电路，用于保护压缩机。

### [对于有线遥控器（可选件）]

问题	解决措施	问题	解决措施
设备不能很好地冷却或加热。	清洁过滤器。	在遥控器中显示CENTRALLY CONTROLLED（中央控制）。	当点亮CENTRALLY CONTROLLED（中央控制）信息时，不能使用遥控器的开始和停止功能。
加热模式下，在到达设定的温度之前设备会停止操作。	当室外的温度低而湿度高时，会凝结成霜。等待大约10分钟，等霜融化。	在重新启动设备之后不能立即使用开始和停止功能。	等待大约3分钟（操作停止，以防止对空调器造成损坏）。
送风方向突然改变。	以向下的方向送风并且在冷却模式下操作1个小时后，设备将会自动改变到“水平送风”模式。 当设备处于加热或除霜模式时，它将自动改变为“水平送风”模式。	在遥控器上显示“H0”。	正在执行自动启动测试（将持续大约2分钟）。
从室内机组中排出白色薄雾。	当室内有较高的湿度，并且设备刚刚开机时，可能会出现这种现象。	在遥控器中显示一个错误代码。无线遥控器的接收器的操作显示闪烁。	正在执行自诊断功能以保护空调器。 *不可试图自行修理。关闭主开关，并且与购买空调机的经销商联络。向他/她提供设备的名称以及显示在遥控器上的信息。
操作时，遥控器的指示灯不亮。	开启电源开关，将显示“·”。		

备注：在电源切断之后，本机不会自动地重新启动。您必须按下遥控器上的POWER-ON/OFF（电源打开/关闭）按钮才能重新启动本机。

如果上述各项均不适用，可关闭主开关并且与您购买空调机的经销商联络，告诉他型号名称和问题的性质。切勿试图亲自装配本机。

在下列任何情况下，应关闭主电源开关并且与您的当地经销商联系有开检修事项：

- 操作灯（在主机上）闪烁。
- 开关不能正常运行。
- 断路器由于保险丝经常烧断而常常跳闸。
- 水意外地溅入本机内。
- 本机漏水。
- 某件物品意外地溅入空调机内。
- 在运行期间听到异常噪声。

### 运行范围

		室内吸气温度	室外吸气温度
冷气	最高	35℃干球(温度), 22.5℃湿球(温度)	46℃干球(温度)
	最低	19℃干球(温度), 15℃湿球(温度)	-5℃干球(温度)
暖气	最高	28℃干球(温度)	21℃干球(温度), 15℃湿球(温度)
	最低	17℃干球(温度)	-11℃干球(温度), -12℃湿球(温度)

出现下列各种情况，并不表示发生任何故障：

气味：在本机吸入诸如烟味或者化妆品之类的气味之后，这些气味可能继续存留。

液体流入室内机组的声音：这在运行期间或者运行之后发生，但只是冷却剂在本机内正在循环的声音。

来自室内机组的“滴答”声：当开始或者停止冷却或者加热时可能发生。这是由于温度的改变使室内的机组发生轻微的收缩或者扩张而引起的。信息“CENTRALLY CONTROLLED（中央控制）”一不时出现在LCD面板上：此信息可能出现在LCD面板上，这并不表明出现任何故障。

### 安装/更换电池和重新启动操作（对于无线遥控器）的遥控器设定

- 在安装及更换电池后必须按下复位按钮。
- 在重新启动设定后，当安装和更换电池时，初始设定会被使用。

		初始设定	重新启动	
操作模式		风扇	上一个操作模式	
温度设定		—	上一个温度设定	
风扇速度		高	上一个风扇速度	
气流方向	水平	操作模式	冷却-干燥	水平
			加热	上一个设定
			风扇	水平

备注：本空调机内注入的致冷剂是安全的。致冷剂一般不会泄漏，但是如果致冷剂气体在室内泄漏，并与风扇式空气加热器、空间加热器和炉子等的火接触，将会产生有害物质。  
当进行维修时，请务必要求维修人员检查致冷剂是否有泄漏。

## 5. 规格

### ■ PLA-RP-AA+PU(H)-P-GAA

型号	RP1.6	RP2	RP2.5	RP3	RP4	RP5	RP6
能力 (冷却/加热) <kW>*1	4.50/4.95	5.60/6.35	6.70/7.30	7.70/9.20	9.60/10.50	13.30/15.60	14.20/17.00
总输入 (冷却/加热) <kW>*1	1.72/1.70	2.53/2.20	2.57/2.40	3.42/3.48	3.68/3.91	5.09/5.54	5.90/6.35
电源 (电压<V>/频率<Hz>)	-						
尺寸 (高) <mm>*2	258 (30)				298 (30)		
尺寸 (宽) <mm>*2	840 (950)						
尺寸 (深) <mm>*2	840 (950)						
风扇额定流量 (低档-中档2-中档1-高档) <m <sup>3</sup> /min>	11-12-13-14	14-15-16-18		15-16-18-20	20-23-26-28	22-25-28-30	
噪声级 (低档-中档2-中档1-高档) <dB>	27-28-29-31	28-29-31-33		28-30-32-34	33-36-39-41	37-40-43-45	
净重<kg>*2	24 (5)				30 (5)	32 (5)	

### ■ PU(H)-P-GAA

型号	P1.6V P1.6Y	P2V P2Y	P2.5V P2.5Y	P3V P3Y	P4V P4Y	P5Y	P6Y
电源 (电压<V>/频率<Hz>)	V:~/N220-230-240/50, Y:3N~380-400-415/50						
尺寸 (高) <mm>	650	855			1260		
尺寸 (宽) <mm>	900				1050		
尺寸 (深) <mm>	330+20						
风扇额定流量<m <sup>3</sup> /min>	45	55	50	85	95	100	
净重<kg>	54	74	79	97	112	113	

### ■ PLA-RP-AA+PUHZ-RP-VHA

型号	RP1.6	RP2	RP2.5	RP3	RP4	RP5	RP6
能力 (冷却/加热) <kW>*1	3.60/4.10	5.00/6.00	6.00/7.00	7.10/8.00	10.00/11.20	12.50/14.00	14.00/16.00
总输入 (冷却/加热) <kW>*1	1.07/1.12	1.55/1.62	1.65/1.85	1.97/2.34	3.03/3.39	3.89/4.27	4.99/4.91
电源 (电压<V>/频率<Hz>)	-						
尺寸 (高) <mm>*2	258 (30)				298 (30)		
尺寸 (宽) <mm>*2	840 (950)						
尺寸 (深) <mm>*2	840 (950)						
风扇额定流量 (低档-中档2-中档1-高档) <m <sup>3</sup> /min>	11-12-13-14	14-15-16-18		15-16-18-20	20-23-26-28	22-25-28-30	
噪声级 (低档-中档2-中档1-高档) <dB>	27-28-29-31	28-29-31-33		28-30-32-34	33-36-39-41	37-40-43-45	
净重<kg>*2	24 (5)				30 (5)	32 (5)	

### ■ PUHZ-RP-VHA

型号	RP1.6V	RP2V	RP2.5V	RP3V	RP4V	RP5V	RP6V
电源 (电压<V>/频率<Hz>)	V:~/N 220-230-240/50						
尺寸 (高) <mm>	600	943			1350		
尺寸 (宽) <mm>	800	950					
尺寸 (深) <mm>	300+15		330+30				
风扇额定流量<m <sup>3</sup> /min>	35	55			100		
净重<kg>	45	69			113		

\*1 冷却：室内27℃DB/19℃WB，室外35℃DB  
 加热：室内20℃DB，室外7℃DB/6℃WB

\*2 ( ) 内数字表示面板的尺寸。







---

Please be sure to put the contact address/telephone number on  
this manual before handing it to the customer.