

**DAIKIN**

**INVERTER**

DAIKIN ROOM AIR CONDITIONER

## **Operation Manual**

**MODELS**

**FVXS25FV1A    FVXS50FV1A**

**FVXS35FV1A**

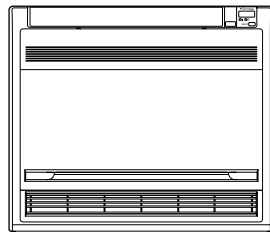

# CONTENTS

## READ BEFORE OPERATION

---

Safety precautions .....	2
Names of parts .....	4
Preparation Before Operation .....	7

## OPERATION

---

AUTO · DRY · COOL · HEAT · FAN Operation .....	10
Adjusting the Air Flow Direction .....	12
POWERFUL Operation .....	14
OUTDOOR UNIT QUIET Operation.....	15
ECONO Operation .....	16
TIMER Operation .....	17
WEEKLY TIMER Operation .....	19
Note for Multi System .....	24

## CARE

---

Care and Cleaning .....	26
-------------------------	----

## TROUBLE SHOOTING

---

Trouble Shooting .....	29
------------------------	----

# Safety precautions

- Keep this manual where the operator can easily find them.
- Read this manual attentively before starting up the unit.
- For safety reason the operator must read the following cautions carefully.
- This manual classifies precautions into WARNING and CAUTION. Be sure to follow all precautions below: they are all important for ensuring safety.

## **WARNING**

If you do not follow these instructions exactly, the unit may cause property damage, personal injury or loss of life.

## **CAUTION**

If you do not follow these instructions exactly, the unit may cause minor or moderate property damage or personal injury.



Never do.



Be sure to earth the air conditioner.



Never touch the air conditioner (including the remote controller) with a wet hand.





Be sure to follow the instructions.



Never cause the air conditioner (including the remote controller) to get wet.

## **WARNING**

- In order to avoid fire, explosion or injury, do not operate the unit when harmful, among which flammable or corrosive gases, are detected near the unit. 
- It is not good for health to expose your body to the air flow for a long time.
- Do not put a finger, a rod or other objects into the air outlet or inlet. As the fan is rotating at a high speed, it will cause injury.
- Do not attempt to repair, relocate, modify or reinstall the air conditioner by yourself. Incorrect work will cause electric shocks, fire etc.  
For repairs and reinstallation, consult your Daikin dealer for advice and information.

- The refrigerant used in the air conditioner is safe. Although leaks should not occur, if for some reason any refrigerant happens to leak into the room, make sure it does not come in contact with any flame as of gas heaters, kerosene heaters or gas range. 
- If the air conditioner is not cooling (heating) properly, the refrigerant may be leaking, so call your dealer. When carrying out repairs accompanying adding refrigerant, check the content of the repairs with our service staff.
- Do not attempt to install the air conditioner by your self. Incorrect work will result in water leakage, electric shocks or fire. For installation, consult the dealer or a qualified technician.
- In order to avoid electric shock, fire or injury, if you detect any abnormally such as smell of fire, stop the operation and turn off the breaker. And call your dealer for instructions.
- Depending on the environment, an earth leakage breaker must be installed. Lack of an earth leakage breaker may result in electric shocks or fire.

- The air conditioner must be earthed. Incomplete earthing may result in electric shocks. Do not connect the earth line to a gas pipe, water pipe, lightning rod, or a telephone earth line. 

## **CAUTION**

- In order to avoid any quality deterioration, do not use the unit for cooling precision instruments, food, plants, animals or works of art. 
- Never expose little children, plants or animals directly to the air flow.

- Do not place appliances which produce open fire in places exposed to the air flow from the unit or under the indoor unit. It may cause incomplete combustion or deformation of the unit due to the heat.
- Do not block air inlets nor outlets. Impaired air flow may result in insufficient performance or trouble.
- Do not stand or sit on the outdoor unit. Do not place any object on the unit to avoid injury, do not remove the fan guard.
- Do not place anything under the indoor or outdoor unit that must be kept away from moisture. In certain conditions, moisture in the air may condense and drip.
- After a long use, check the unit stand and fittings for damage.
- Do not touch the air inlet and aluminum fins of outdoor unit. It may cause injury.
- The appliance is not intended for use by young children or infirm persons without supervision.
- Young children should be supervised to ensure that they do not play with the appliance.

- To avoid oxygen deficiency, ventilate the room sufficiently if equipment with burner is used together with the air conditioner.
- Before cleaning, be sure to stop the operation, turn the breaker off or pull out the supply cord.
- Do not connect the air conditioner to a power supply different from the one as specified. It may cause trouble or fire.
- Arrange the drain hose to ensure smooth drainage. Incomplete draining may cause wetting of the building, furniture etc.
- Do not place objects in direct proximity of the outdoor unit and do not let leaves and other debris accumulate around the unit.  
Leaves are a hotbed for small animals which can enter the unit. Once in the unit, such animals can cause malfunctions, smoke or fire when making contact with electrical parts.



- Do not operate the air conditioner with wet hands.



- Do not wash the indoor unit with excessive water, only use a slightly wet cloth.
- Do not place things such as vessels containing water or anything else on top of the unit. Water may penetrate into the unit and degrade electrical insulations, resulting in an electric shock.



### **Installation site.**

- To install the air conditioner in the following types of environments, consult the dealer.
  - Places with an oily ambient or where steam or soot occurs.
  - Salty environment such as coastal areas.
  - Places where sulfide gas occurs such as hot springs.
  - Places where snow may block the outdoor unit.

The drain from the outdoor unit must be discharged to a place of good drainage.

### **Consider nuisance to your neighbours from noises.**

- For installation, choose a place as described below.
  - A place solid enough to bear the weight of the unit which does not amplify the operation noise or vibration.
  - A place from where the air discharged from the outdoor unit or the operation noise will not annoy your neighbours.

### **Electrical work.**

- For power supply, be sure to use a separate power circuit dedicated to the air conditioner.

### **System relocation.**

- Relocating the air conditioner requires specialized knowledge and skills. Please consult the dealer if relocation is necessary for moving or remodeling.

# Names of parts

## Indoor Unit

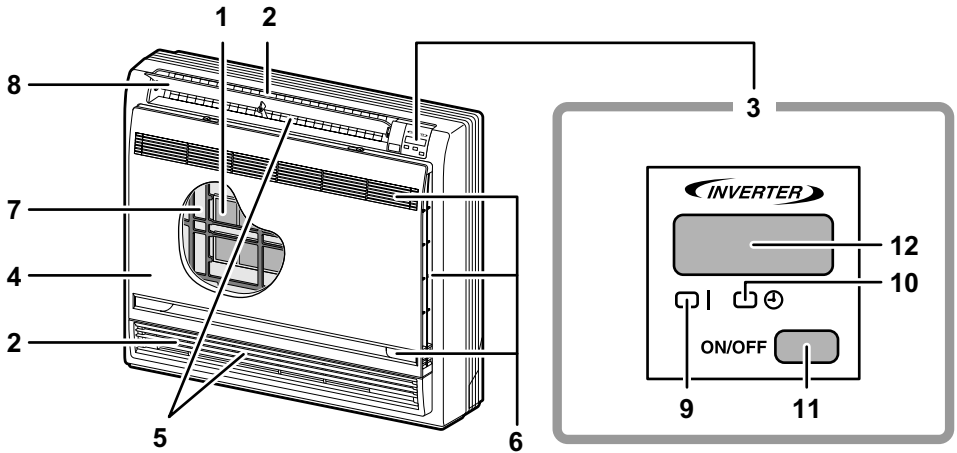

## Opening the Front Panel

How to open the front panel: (page 26.)

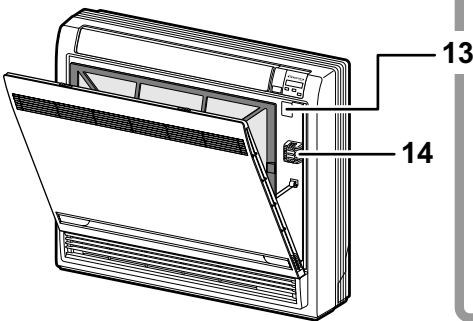

### Air outlet selection switch

- This setting blows air from upper outlet only.
- This setting automatically decides a blow pattern depending on mode and conditions.
- This setting is recommended.
- The unit is shipped from the factory with this setting.

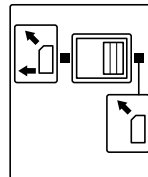

## ⚠ CAUTION

Before opening the front panel, be sure to stop the operation and turn the breaker OFF. Do not touch the metal parts on the inside of the indoor unit, as it may result in injury.

## ■ Outdoor Unit

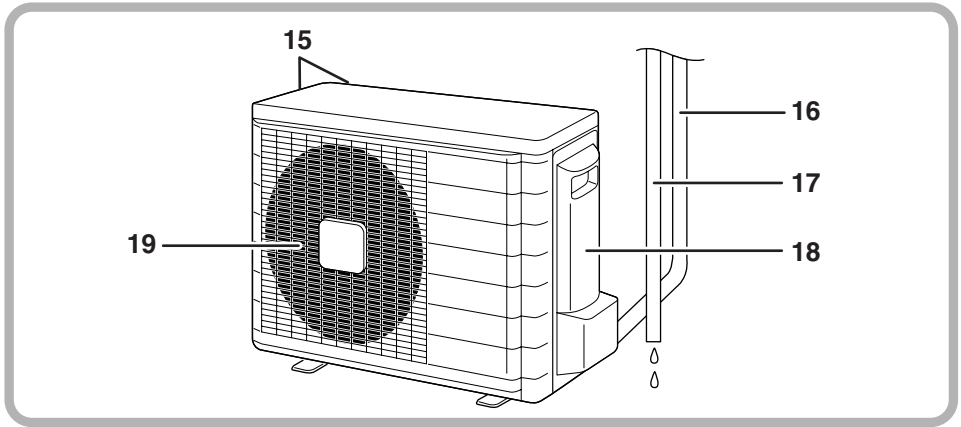

## ■ Indoor Unit

### 1. Titanium Apatite Photocatalytic Air-Purifying Filter:

- These filters are attached to the inside of the air filters.

### 2. Air outlet

### 3. Display

### 4. Front panel

### 5. Louvers (vertical blades): (page 12.)

- The louvers are inside of the air outlet.

### 6. Air inlet

### 7. Air filter

### 8. Flap (horizontal blade): (page 12.)

### 9. Operation lamp (green)

### 10. TIMER lamp (yellow): (page 17.)

### 11. Indoor Unit ON/OFF switch:

- Push this switch once to start operation.  
Push once again to stop it.

- The operation mode refers to the following table.

Mode	Temperature setting	Air flow rate
COOL	22°C	AUTO
AUTO	25°C	AUTO

- This switch is useful when the remote controller is missing.

### 12. Signal receiver:

- It receives signals from the remote controller.
- When the unit receives a signal, you will hear a short beep.
  - Operation start ..... beep-beep
  - Settings changed ..... beep
  - Operation stop..... beeeeeeep

### 13. Air outlet selection switch: (page 13.)

### 14. Room temperature sensor:

- It senses the air temperature around the unit.

## ■ Outdoor Unit

### 15. Air inlet: (Back and side)

### 16. Refrigerant piping and inter-unit cable

### 17. Drain hose

### 18. Earth terminal:

- It is inside of this cover.

### 19. Air outlet

Appearance of the outdoor unit may differ from some models.

# Remote Controller

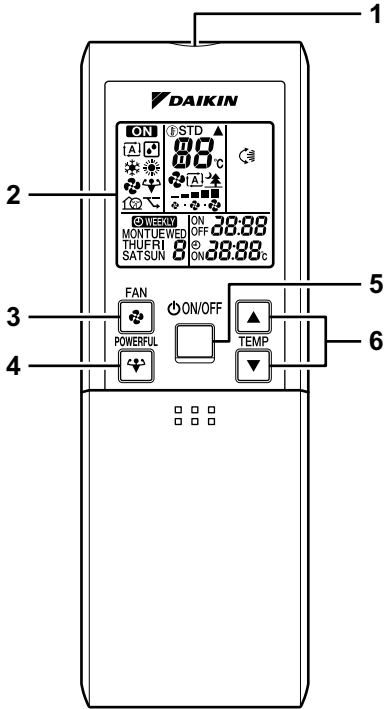

<ARC452A2>

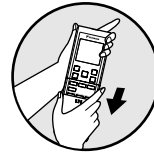

<Open the lid>

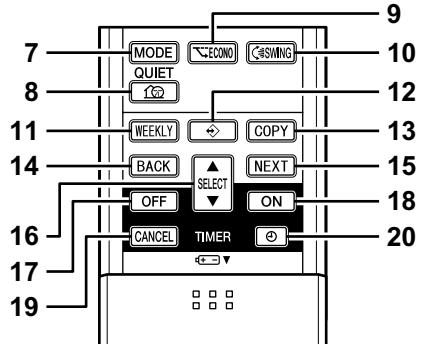

## 1. Signal transmitter:

- It sends signals to the indoor unit.

## 2. Display:

- It displays the current settings.  
(In this illustration, each section is shown with all its displays ON for the purpose of explanation.)

## 3. FAN setting button:

- It selects the air flow rate setting.

## 4. POWERFUL button:

- POWERFUL operation (page 14.)

## 5. ON/OFF button:

- Press this button once to start operation.  
Press once again to stop it.

## 6. TEMPERATURE adjustment buttons:

- It changes the temperature setting.

## 7. MODE selector button:

- It selects the operation mode.  
(AUTO/DRY/COOL/HEAT/FAN) (page 10.)

## 8. QUIET button:

- OUTDOOR UNIT QUIET operation (page 15.)

## 9. ECONO button:

- ECONO operation (page 16.)

## 10. SWING button:

- Adjusting the Air Flow Direction (page 12.)

## 11. WEEKLY button:

- WEEKLY TIMER operation (page 19.)

## 12. PROGRAM button:

- WEEKLY TIMER operation (page 19.)

## 13. COPY button:

- WEEKLY TIMER operation (page 19.)

## 14. BACK button:

- WEEKLY TIMER operation (page 19.)

## 15. NEXT button:

- WEEKLY TIMER operation (page 19.)

## 16. SELECT button:

- It changes the timer setting (page 17.)

## 17. OFF TIMER button:

- (page 17.)

## 18. ON TIMER button:

- (page 18.)

## 19. TIMER CANCEL button:

- It cancels the timer setting. (page 17, 18.)

- It cannot be used for the WEEKLY TIMER operation.

## 20. CLOCK button:

- (page 8.)

# Preparation Before Operation

## ■ To set the batteries

1. Slide the front cover to take it off.
2. Set two dry batteries (LR03·AAA).
3. Set the front cover as before.

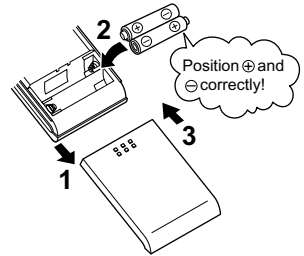

## ■ To operate the remote controller

- To use the remote controller, aim the transmitter at the indoor unit. If there is anything to block signals between the unit and the remote controller, such as a curtain, the unit will not operate.
- Do not drop the remote controller. Do not get it wet.
- The maximum distance for communication is about 7m.

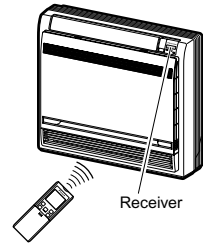

## ■ To fix the remote controller holder on the wall

1. Choose a place from where the signals reach the unit.
2. Fix the holder to a wall, a pillar, etc. with the screws supplied with the holder.
3. Place the remote controller in the remote controller holder.

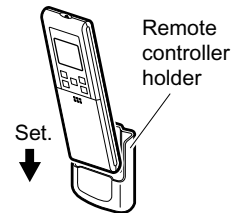

- To remove, pull it upwards.

## ATTENTION

### ■ About batteries

- When replacing the batteries, use batteries of the same type, and replace the two old batteries together.
- When the system is not used for a long time, take the batteries out.
- We recommend replacing once a year, although if the remote controller display begins to fade or if reception deteriorates, please replace with new alkaline batteries. Using manganese batteries reduces the lifespan.
- The attached batteries are provided for the initial use of the system.  
The usable period of the batteries may be short depending on the manufactured date of the air conditioner.

### ■ About remote controller

- Never expose the remote controller to direct sunlight.
- Dust on the signal transmitter or receiver will reduce the sensitivity. Wipe off dust with soft cloth.
- Signal communication may be disabled if an electronic-starter-type fluorescent lamp (such as inverter-type lamps) is in the room. Consult the shop if that is the case.
- If the remote controller signals happen to operate another appliance, move that appliance to somewhere else, or consult the shop.



# Preparation Before Operation

## ■ To set the clock

1. Press “CLOCK button”.

0:00 is displayed.

MON and  blinks.

2. Press “SELECT button” to set the current day of the week.

3. Press “CLOCK button”.

 blinks.

4. Press “SELECT button” to set the clock to the present time.

Holding down “▲” or “▼” button rapidly increases or decreases the time display.

5. Press “CLOCK button”.

Always point the remote controller at the indoor unit when pushing the buttons when setting the indoor unit’s internal clock.

 blinks.

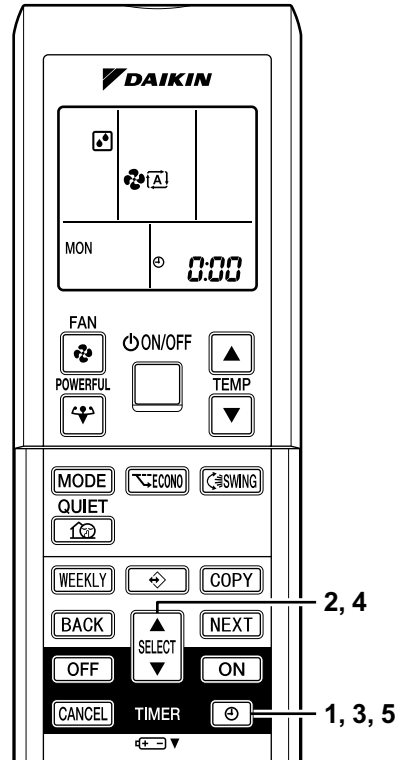

## NOTE

- If the indoor unit’s internal clock is not set to the correct time, the WEEKLY TIMER will not operate punctually.

## ■ Turn the breaker ON

- Turning ON the breaker closes the flap. (This is a normal procedure.)

## NOTE

### ■ Tips for saving energy

- Be careful not to cool (heat) the room too much. Keeping the temperature setting at a moderate level helps save energy.
- Cover windows with a blind or a curtain. Blocking sunlight and air from outdoors increases the cooling (heating) effect.
- Clogged air filters cause inefficient operation and waste energy. Clean them once in about every two weeks.

Recommended temperature setting
---------------------------------

For cooling: 26°C – 28°C For heating: 20°C – 24°C
--

### ■ Please note

- The air conditioner always consumes 15-35 watts of electricity even while it is not operating.
- If you are not going to use the air conditioner for a long period, for example in spring or autumn, turn the breaker OFF.
- Use the air conditioner in the following conditions.

Mode	Operating conditions	If operation is continued out of this range
COOL	Outdoor temperature: (3MXS) –5 to 46°C (4MXS) –10 to 46°C (3/4MKS) 10 to 46°C (RXS) 10 to 46°C Indoor temperature: 18 to 32°C Indoor humidity: 80% max.	<ul style="list-style-type: none"> <li>• A safety device may work to stop the operation. (In multi system, it may work to stop the operation of the outdoor unit only.)</li> <li>• Condensation may occur on the indoor unit and drip.</li> </ul>
HEAT	Outdoor temperature: (3/4MXS) –15 to 24°C (RXS25/35) –10 to 24°C (RXS50) –15 to 24°C Indoor temperature: 10 to 30°C	<ul style="list-style-type: none"> <li>• A safety device may work to stop the operation.</li> </ul>
DRY	Outdoor temperature: (3MXS) –5 to 46°C (4MXS) –10 to 46°C (3/4MKS) 10 to 46°C (RXS) 10 to 46°C Indoor temperature: 18 to 32°C Indoor humidity: 80% max.	<ul style="list-style-type: none"> <li>• A safety device may work to stop the operation.</li> <li>• Condensation may occur on the indoor unit and drip.</li> </ul>

- Operation outside this humidity or temperature range may cause a safety device to disable the system.

# AUTO · DRY · COOL · HEAT · FAN Operation

The air conditioner operates with the operation mode of your choice.

From the next time on, the air conditioner will operate with the same operation mode.

## ■ To start operation

### 1. Press “MODE selector button” and select a operation mode.

- Each pressing of the button advances the mode setting in sequence.

: AUTO

: DRY

: COOL

: HEAT

: FAN

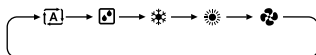

### 2. Press “ON/OFF button”.

- The OPERATION lamp lights up.

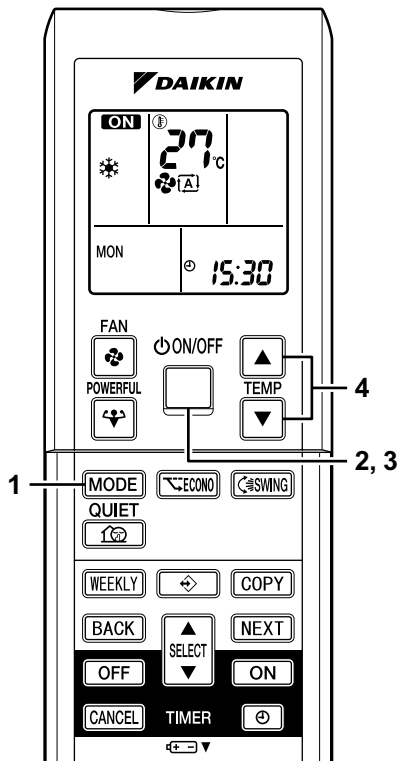
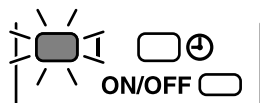

## ■ To stop operation

### 3. Press “ON/OFF button” again.

- Then OPERATION lamp goes off.





## ■ To change the temperature setting

### 4. Press “TEMPERATURE adjustment button”.

DRY or FAN mode	AUTO or COOL or HEAT mode
The temperature setting is not variable.	Press “▲” to raise the temperature and press “▼” to lower the temperature.
	Set to the temperature you like. 

## ■ To change the air flow rate setting

### 5. Press “FAN setting button”.

DRY mode	AUTO or COOL or HEAT or FAN mode
The air flow rate setting is not variable.	Five levels of air flow rate setting from “  ” to “  ” plus “  ” “  ” are available. 

- Indoor unit quiet operation

When the air flow is set to “”, the noise from the indoor unit will become quieter.

Use this when making the noise quieter.

The unit might lose capacity when the air flow rate is set to a weak level.

## NOTE

### ■ Note on HEAT operation

- Since this air conditioner heats the room by taking heat from outdoor air to indoors, the heating capacity becomes smaller in lower outdoor temperatures. If the heating effect is insufficient, it is recommended to use another heating appliance in combination with the air conditioner.
- The heat pump system heats the room by circulating hot air around all parts of the room. After the start of heating operation, it takes some time before the room gets warmer.
- In heating operation, frost may occur on the outdoor unit and lower the heating capacity. In that case, the system switches into defrosting operation to take away the frost.
- During defrosting operation, hot air does not flow out of indoor unit.

### ■ Note on COOL operation

- This air conditioner cools the room by blowing the hot air in the room outside, so if the outside temperature is high, performance drops.

### ■ Note on DRY operation

- The computer chip works to rid the room of humidity while maintaining the temperature as much as possible. It automatically controls temperature and fan strength, so manual adjustment of these functions is unavailable.

### ■ Note on AUTO operation

- In AUTO operation, the system selects a temperature setting and an appropriate operation mode (COOL or HEAT) based on the room temperature at the start of the operation.
- The system automatically reselects setting at a regular interval to bring the room temperature to user-setting level.
- If you do not like AUTO operation, you can manually select the operation mode and setting you like.

### ■ Note on air flow rate setting

- At smaller air flow rates, the cooling (heating) effect is also smaller.

# Adjusting the Air Flow Direction

You can adjust the air flow direction to increase your comfort.

## ■ To adjust the horizontal blade (flap)

### 1. Press “SWING button”.

- “” is displayed on the LCD and the flaps will begin to swing.

### 2. When the flap has reached the desired position, press “SWING button” once more.

- The flap will stop moving.
- “” disappears from the LCD.

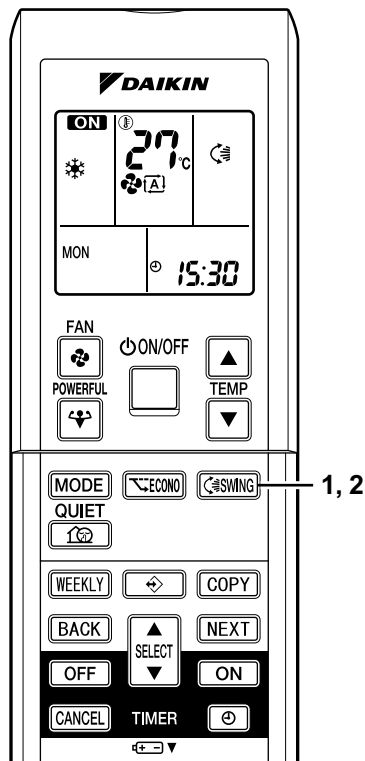

## ■ To adjust the vertical blades (louvers)

Hold the knob and move the louver.  
(You will find a knob on the left-side and the right-side blades.)

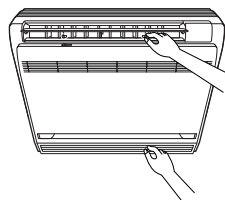

## Notes on flap and louvers angle

- Unless “SWING” is selected, you should set the flap at a near-horizontal angle in HEAT mode and at a upward position in COOL or DRY mode to obtain the best performance.

### ■ ATTENTION

- When adjusting the flap by hand, turn off the unit, and use the remote controller to restart the unit.
- Be careful when adjusting the louvers. Inside the air outlet, a fan is rotating at a high speed.

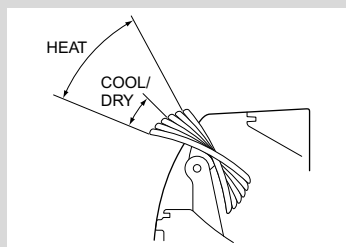

## ■ Air flow selection

- Make air flow selection according to what suits you.

### When setting the air flow selection switch to .

- Air conditioner automatically decides the appropriate blowing pattern depending on the operating mode/situation.

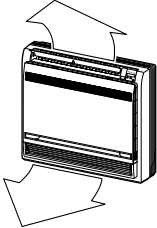
Operating mode	Situation	Blowing pattern
COOL mode	<ul style="list-style-type: none"> <li>• When the room has become fully cool, or when one hour has passed since turning on the air conditioner.</li> </ul>	<ul style="list-style-type: none"> <li>• So that air does not come into direct contact with people, air is blown upper air outlet, room temperature is equalized.</li> </ul>
	<ul style="list-style-type: none"> <li>• At start of operation or other times when the room is not fully cooled.</li> </ul>	 <ul style="list-style-type: none"> <li>• Air is blown from the upper and lower air outlets for high speed cooling during COOL mode, and for filling the room with warm air during HEAT mode.</li> </ul>
HEAT mode	<ul style="list-style-type: none"> <li>• At times other than below. (Normal time.)</li> </ul>	
	<ul style="list-style-type: none"> <li>• At start or when air temperature is low.</li> </ul>	

- During Dry mode, so that cold air does not come into direct contact with people, air is blown upper air outlet.

### When setting the air outlet selection switch to .

- Regardless of the operating mode or situation, air blows from the upper air outlet.
- Use this switch when you do not want air coming out of the lower air outlet. (While sleeping etc.)

## CAUTION

- Do not try to adjust the flap by hand.
- When adjusting by hand, the mechanism may not operate properly or condensation may drip from air outlets.

# POWERFUL Operation

POWERFUL operation quickly maximizes the cooling (heating) effect in any operation mode. You can get the maximum capacity.

## ■ To start POWERFUL operation

1. Press “POWERFUL button”.
  - POWERFUL operation ends in 20minutes. Then the system automatically operates again with the settings which were used before POWERFUL operation.
  - When using POWERFUL operation, there are some functions which are not available.
  - “❄️” is displayed on the LCD.

## ■ To cancel POWERFUL operation

2. Press “POWERFUL button” again.
  - “❄️” disappears from the LCD.

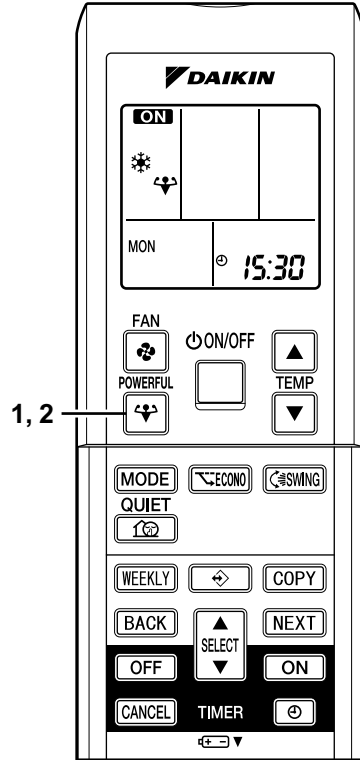

## NOTE

### ■ Notes on POWERFUL operation

- POWERFUL Operation cannot be used together with ECONO or QUIET Operation. Priority is given to the function of whichever button is pressed last.
- POWERFUL Operation can only be set when the unit is running. Pressing the operation stop button causes the settings to be canceled, and the “❄️” disappears from the LCD.
- **In COOL and HEAT mode**  
To maximize the cooling (heating) effect, the capacity of outdoor unit must be increased and the air flow rate be fixed to the maximum setting. The temperature and air flow settings are not variable.
- **In DRY mode**  
The temperature setting is lowered by 2.5°C and the air flow rate is slightly increased.
- **In FAN mode**  
The air flow rate is fixed to the maximum setting.
- **When using priority-room setting**  
See “Note for Multi System”. (page 24.)

# OUTDOOR UNIT QUIET Operation

OUTDOOR UNIT QUIET operation lowers the noise level of the outdoor unit by changing the frequency and fan speed on the outdoor unit. This function is convenient during night.

## ■ To start OUTDOOR UNIT QUIET operation

1. Press “QUIET button”.
  - “” is displayed on the LCD.

## ■ To cancel OUTDOOR UNIT QUIET operation

2. Press “QUIET button” again.
  - “” disappears from the LCD.

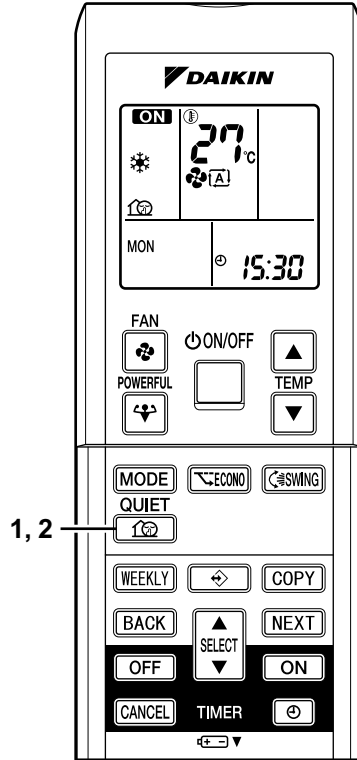

## NOTE

### ■ Note on OUTDOOR UNIT QUIET operation

- If using a multi system, this function will work only when the OUTDOOR UNIT QUIET operation is set on all operated indoor units. However, if using priority-room setting, see “Note for Multi System”. (page 24.)
- This function is available in COOL, HEAT, and AUTO modes. (This is not available in FAN and DRY mode.)
- POWERFUL operation and OUTDOOR UNIT QUIET operation cannot be used at the same time. Priority is given to the function of whichever button is pressed last.
- If operation is stopped using the remote controller or the main unit ON/OFF switch when using OUTDOOR UNIT QUIET operation, “” will remain on the remote controller display.



# ECONO Operation

ECONO operation is a function which enables efficient operation by lowering the maximum power consumption value.

## ■ To start ECONO operation

1. Press “ECONO button”.
  - “” is displayed on the LCD.

## ■ To cancel ECONO operation

2. Press “ECONO button” again.
  - “” disappears from the LCD.

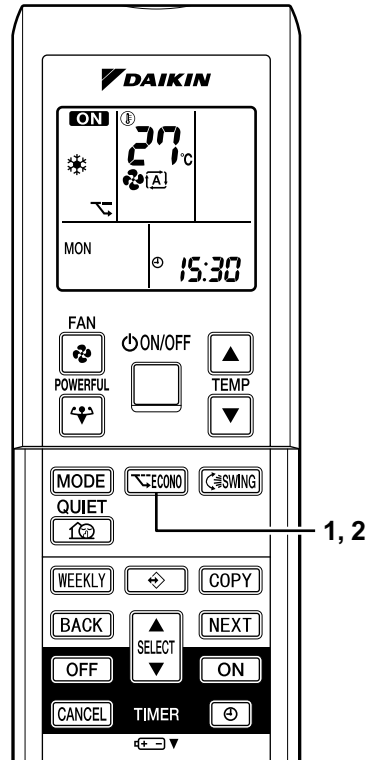

## NOTE

- ECONO Operation can only be set when the unit is running. Pressing the operation stop button causes the settings to be canceled, and the “” disappears from the LCD.
- ECONO operation is a function which enables efficient operation by limiting the power consumption of the outdoor unit (operating frequency).
- ECONO operation functions in AUTO, COOL, DRY, and HEAT modes.
- POWERFUL operation and ECONO operation cannot be used at the same time. Priority is given to the function of whichever button is pressed last.
- Power consumption may not drop even if ECONO operation is used, when the level of power consumption is already low.

# TIMER Operation

Timer functions are useful for automatically switching the air conditioner on or off at night or in the morning. You can also use OFF TIMER and ON TIMER in combination.

## ■ To use OFF TIMER operation

- Check that the clock is correct.  
If not, set the clock to the present time.  
(page 8.)

### 1. Press “OFF TIMER button”.

0:00 is displayed.

OFF blinks.

### 2. Press “SELECT button” until the time setting reaches the point you like.

- Every pressing of either button increases or decreases the time setting by 10 minutes. Holding down either button changes the setting rapidly.

### 3. Press “OFF TIMER button” again.

- The TIMER lamp lights up.

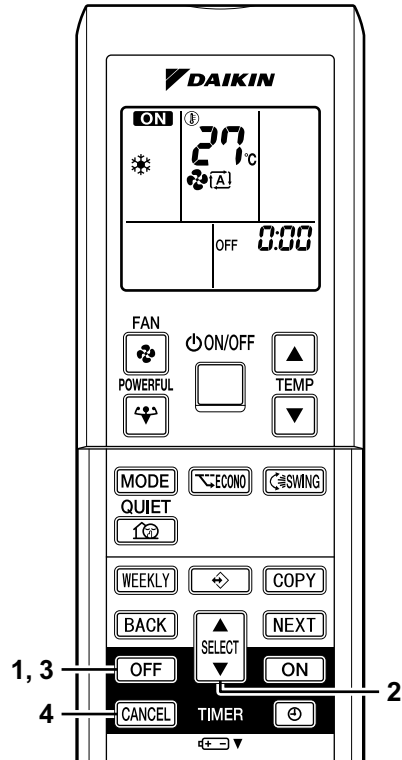

## ■ To cancel the OFF TIMER Operation

### 4. Press “CANCEL button”.

- The TIMER lamp goes off.

## NOTE

- When TIMER is set, the present time is not displayed.
- Once you set ON, OFF TIMER, the time setting is kept in the memory. (The memory is canceled when remote controller batteries are replaced.)
- When operating the unit via the ON/OFF Timer, the actual length of operation may vary from the time entered by the user. (Maximum approx. 10 minutes)

### ■ NIGHT SET MODE

When the OFF TIMER is set, the air conditioner automatically adjusts the temperature setting (0.5°C up in COOL, 2.0°C down in HEAT) to prevent excessive cooling (heating) for your pleasant sleep.

# TIMER Operation

## ■ To use ON TIMER operation

- Check that the clock is correct. If not, set the clock to the present time. (page 8.)

### 1. Press “ON TIMER button”.

6:00 is displayed.

ON blinks.

### 2. Press “SELECT button” until the time setting reaches the point you like.

- Every pressing of either button increases or decreases the time setting by 10 minutes. Holding down either button changes the setting rapidly.

### 3. Press “ON TIMER button” again.

- The TIMER lamp lights up.

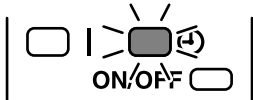

## ■ To cancel ON TIMER operation

### 4. Press “CANCEL button”.

- The TIMER lamp goes off.

## ■ To combine ON TIMER and OFF TIMER

- A sample setting for combining the two timers is shown below.

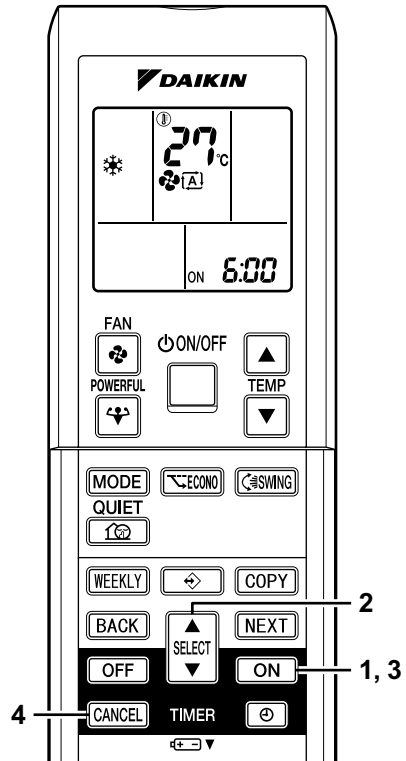
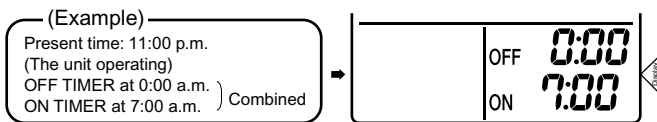

## ATTENTION

### ■ In the following cases, set the timer again.

- After a breaker has turned OFF.
- After a power failure.
- After replacing batteries in the remote controller.

# WEEKLY TIMER Operation

Up to 4 timer settings can be saved for each day of the week.

## ■ To use WEEKLY TIMER operation

- Make sure the day of the week and time are set. If not, set the day of the week and time. (page 8.)
- The following procedure is to make a reservation on Monday for Tuesday 6:00 am/27°C.

### 1. Press “ button”.

- The day of the week and the reservation number will be displayed.
- 1 to 4 settings can be made per day.



### 2. Press the “SELECT button” to select the desired day of the week and reservation number.

- Pressing the “SELECT button” changes the reservation number and the day of the week.

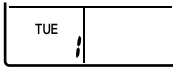

### 3. Press “NEXT button”.

- The day of the week will be set.
- “ WEEKLY” and “ON” blink.



### 4. Press “SELECT button” to select the desired mode.

- “ WEEKLY” and “ON” or “OFF” will flash.

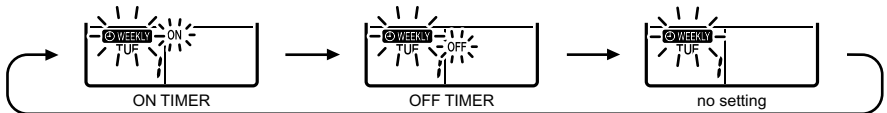

- To go to the next reservation setting, select “no setting”.

### 5. Press “NEXT button”.

- The weekly mode will be set.
- “ WEEKLY” and “6:00” blink.

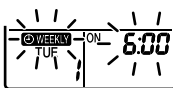

### 6. Press “SELECT button” to select the desired time.

- The time can be set between 0:00 and 23:50 in 10 minute intervals.
- Press “BACK button” to return to the mode setting.

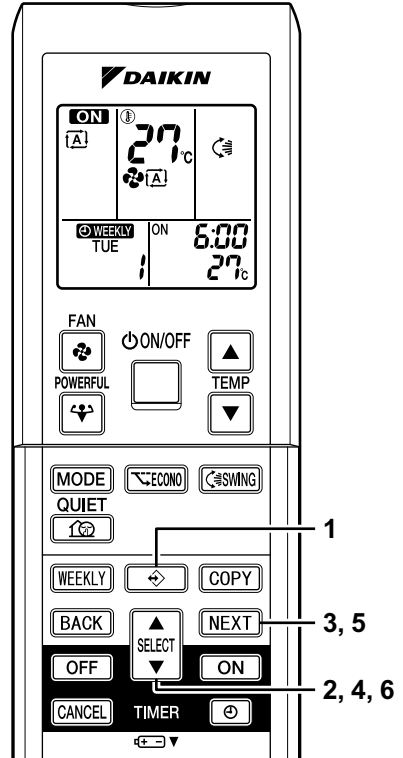

# WEEKLY TIMER Operation

## 7. Press “NEXT button”.

- The time will be set.
- “WEEKLY” and the temperature blink.

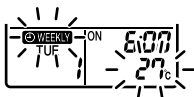

## 8. Press “SELECT button” to select the desired temperature.

- The temperature can be set between 10°C and 32°C.
- To return to the time setting, press “BACK button”.
- The set temperature is only displayed when the mode setting is on.

## 9. Press “NEXT button”.

- The temperature will be set.
- The temperature will be set and go to the next reservation setting.
- Set the following using the same procedures.

## 10. Press “↔ button” to complete the setting.

- Point the remote controller toward the air conditioner and press the buttons to operate. The air conditioner will beep and the operation lamp will flash.

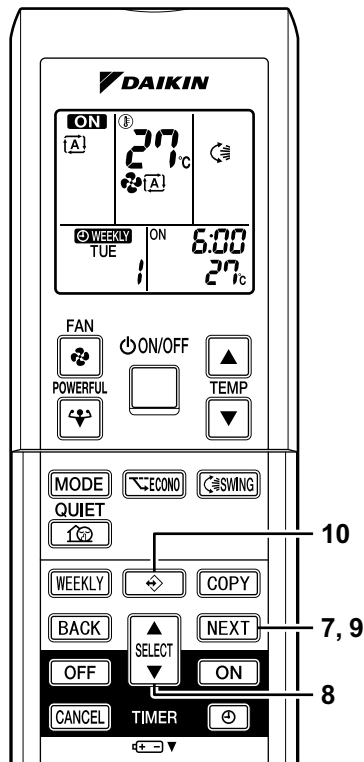

## ■ To cancel WEEKLY TIMER operation

### 11. Press “WEEKLY button” to deactivate the WEEKLY operation.

- The “**WEEKLY**” will disappear from the display.
- The TIMER lamp goes off.
- To reactivate the WEEKLY TIMER operation, press the “WEEKLY button” again.

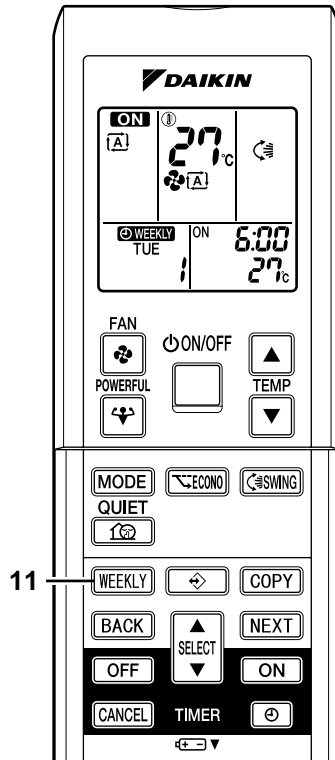

## NOTE

### ■ WEEKLY TIMER

- Do not forget to set the time on the remote control first.
- The day of the week, time and ON/OFF can be set with WEEKLY TIMER. For ON-TIMER, settings other than the above are based on the remote controller settings just before the operation.
- The “WEEKLY button” activates or deactivates the reservation.
- To set WEEKLY TIMER, press “**WEEKLY**” button” and make a reservation according to the procedures.
- Only the time and set temperature set with the weekly timer are sent with the “**WEEKLY**” button”. Set the weekly timer only after setting the operation mode, the fan strength, and the fan direction ahead of time.
- Up to 4 settings per day and up to 28 settings per week can be reserved with WEEKLY TIMER. If a reservation deactivated with “WEEKLY button” is activated once again, the last reservation made will be used.
- Cooling: The unit operates at 18°C even if it is set at 10 to 17°C.
- Heating: The unit operates at 30°C even if it is set at 31 to 32°C.
- Shutting the breaker off, power outages, and other similar events will render operation of the indoor unit’s internal clock inaccurate. Reset the clock. (page 8.)
- The “BACK button” can be used only for the mode, time and temperature settings. It cannot be used to go back to the reservation number.

# WEEKLY TIMER Operation

## ■ Confirming a reservation

- The reservation can be confirmed.

### 1. Press “ button”.

- The day of the week and the reservation number of the current day will be displayed.



### 2. Press “SELECT button” to select the day of the week and the reservation number to be confirmed.

- Pressing the “SELECT button” displays the reservation details.



### 3. Press “ button”.

- Reservation confirmation complete.

## ■ Canceling all reservations

### 4. Hold the “WEEKLY button” for 5 seconds.

- Be sure to direct the remote control toward the main unit and check for a receiving tone.
- This operation is not effective while WEEKLY TIMER is being set.
- All reservations will be canceled.

## ■ Canceling individual reservations

- This function can be used for canceling reservations for each day of the week.
- It can be used while confirming or setting reservations.

### 5. Select the day of the week to be canceled with the “SELECT button”.

### 6. Hold the “WEEKLY button” for 5 seconds.

- The selected reservation will be canceled.

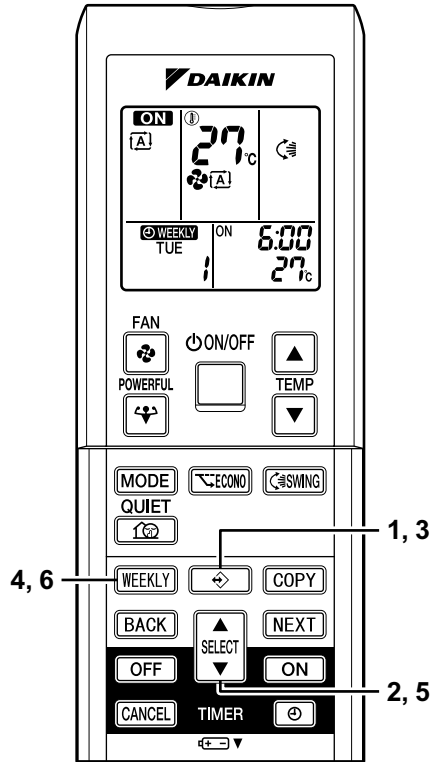

## ■ Setting WEEKLY TIMER using copy mode

- A reservation made once can be easily copied and the same settings used for another day of the week.

1. Press “” button”.
2. Press “SELECT button” to confirm the day of the week to be copied.

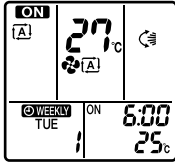

3. Press “COPY button”.
4. Press “SELECT button” to select the destination day of the week.

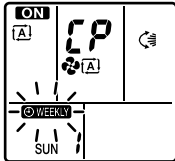

5. Press “COPY button”.
- The reservation will be copied to the selected day of the week. The whole reservation of the selected day of the week will be copied.
  - The reservation can be copied to another day of the week in succession.

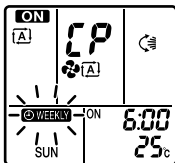

6. Press “” button”.
- Exit copy mode.

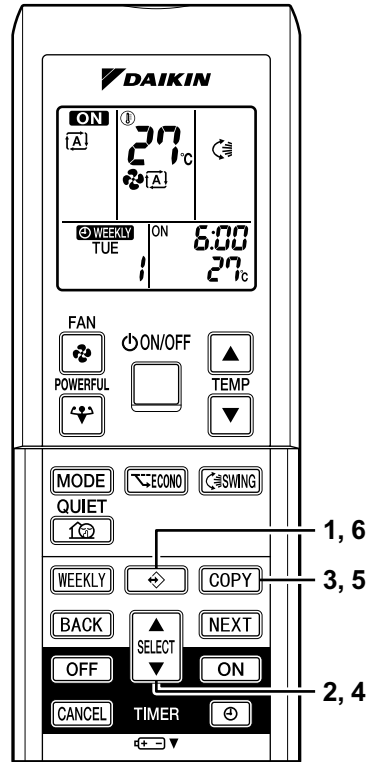

## NOTE

### ■ COPY MODE

- The entire reservation of the source day of the week is copied in the copy mode. Detailed settings can be made after the copy is completed.
- Both WEEKLY TIMER and ON/OFF timer cannot be used at the same time. The ON/OFF timer has priority if it is set while WEEKLY TIMER is still active. WEEKLY TIMER is activated after the reserved ON/OFF timer is completed.



# Note for Multi System

## << What is a “Multi System”? >>

This system has one outdoor unit connected to multiple indoor units.

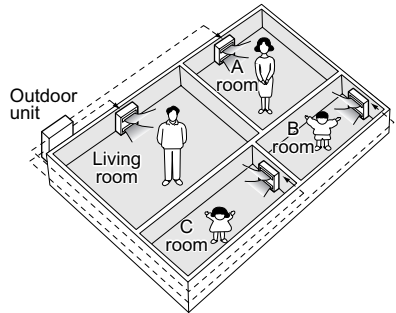

## ■ Selecting the operation mode

### 1. With the Priority Room Setting present but inactive or not present.

When more than one indoor unit is operating, priority is given to the first unit that was turned on. In this case, set the units that are turned on later to the same operation mode (\*1) as the first unit.

Otherwise, they will enter the Standby Mode, and the operation lamp will flash; this does not indicate malfunction.

(\*1)

- COOL, DRY and FAN mode may be used at the same time.
- AUTO mode automatically selects COOL mode or HEAT mode based on the room temperature. Therefore, AUTO mode is available when selecting the same operation mode as that of the room with the first unit to be turned on.

#### <CAUTION>

Normally, the operation mode in the room where the unit is first run is given priority, but the following situations are exceptions, so please keep this in mind.

If the operation mode of the first room is **FAN Mode**, then using **Heating Mode** in any room after this will give priority to **heating**. In this situation, the air conditioner running in FAN Mode will go on standby, and the operation lamp will flash.

### 2. With the Priority Room Setting active.

See “Priority Room Setting” on the next page.

## ■ NIGHT QUIET Mode (Available only for cooling operation)

NIGHT QUIET Mode requires initial programming during installation. Please consult your retailer or dealer for assistance. NIGHT QUIET Mode reduces the operation noise of the outdoor unit during the night time hours to prevent annoyance to neighbors.

- The NIGHT QUIET Mode is activated when the temperature drops 5°C or more below the highest temperature recorded that day. Therefore, when the temperature difference is less than 5°C, this function will not be activated.
- NIGHT QUIET Mode reduces slightly the cooling (heating) efficiency of the unit.

## ■ OUTDOOR UNIT QUIET operation (page 15.)

### 1. With the Priority Room Setting present but inactive or not present.

When using the OUTDOOR UNIT QUIET operation feature with the Multi system, set all indoor units to OUTDOOR UNIT QUIET operation using their remote controllers.

When clearing OUTDOOR UNIT QUIET operation, clear one of the operating indoor units using their remote controller. However OUTDOOR UNIT QUIET operation display remains on the remote controller for other rooms. We recommend you release all rooms using their remote controllers.

### 2. With the Priority Room Setting active.

See “Priority Room Setting” on the next page.

## ■ Cooling / Heating mode lock (Available only for heat pump models)

The Cooling / Heating Mode Lock requires initial programming during installation. Please consult your retailer or dealer for assistance. The Cooling / Heating Mode Lock sets the unit forcibly to either Cooling or Heating Mode. This function is convenient when you wish to set all indoor units connected to the Multi system to the same operation mode.

## ■ Priority Room Setting

The Priority Room Setting requires initial programming during installation. Please consult your retailer or dealer for assistance.

The room designated as the Priority Room takes priority in the following situations;

### 1. Operation mode Priority.

As the operation mode of the Priority Room takes precedence, the user can select a different operation mode from other rooms.

〈Example〉

\* Room A is the Priority Room in the examples.

When COOL mode is selected in Room A while operating the following modes in Room B,C and D:

Operation mode in Room B, C and D	Status of Room B, C and D when the unit in Room A is in COOL mode
COOL or DRY or FAN	Current operation mode maintained
HEAT	The unit enters Standby Mode. Operation resumes when the Room A unit stops operating.
AUTO	If the unit is set to COOL mode, operation continues. If set to HEAT mode, it enters Standby Mode. Operation resumes when the Room A unit stops operating.

### 2. Priority when POWERFUL operation is used.

〈Example〉

\* Room A is the Priority Room in the examples.

The indoor units in Rooms A,B,C and D are all operating. If the unit in Room A enters POWERFUL operation, operation capacity will be concentrated in Room A. In such a case, the cooling (heating) efficiency of the units in Rooms B,C and D may be slightly reduced.

### 3. Priority when using OUTDOOR UNIT QUIET operation.

〈Example〉

\* Room A is the Priority Room in the examples.

Just by setting the unit in Room A to QUIET operation, the air conditioner starts OUTDOOR UNIT QUIET operation.

You don't have to set all the operated indoor units to QUIET operation.

# Care and Cleaning



**CAUTION** Before cleaning, be sure to stop the operation and turn the breaker OFF.

## Units

### ■ Indoor unit, Outdoor unit and Remote controller

1. Wipe them with dry soft cloth.

### ■ Front panel

1. **Open the front panel.**

- Slide the two stoppers on the left and right sides inward until they click.

2. **Remove the front panel.**

- Remove the string.
- Allowing the front panel to fall forward will enable you to remove it.

3. **Clean the front panel.**

- Wipe it with a soft cloth soaked in water.
- Only neutral detergent may be used.
- In case of washing the front panel with water, dry it with cloth, dry it up in the shade after washing.

4. **Attach the front panel.**

- Insert the front panel into the grooves of the unit (3 places).
- Attach the string to the right, inner-side of the front grille.
- Close the panel slowly.

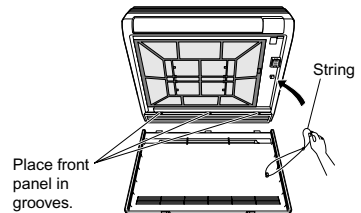
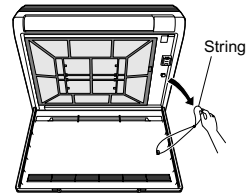
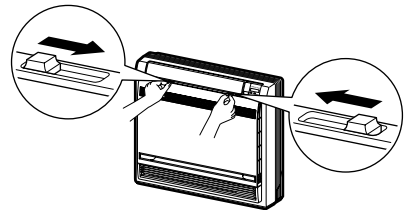

### CAUTION

- Don't touch the metal parts of the indoor unit. If you touch those parts, this may cause an injury.
- When removing or attaching the front panel, use a robust and stable stool and watch your steps carefully.
- When removing or attaching the front panel, support the panel securely with hand to prevent it from falling.
- For cleaning, do not use hot water above 40°C, benzene, gasoline, thinner, nor other volatile oils, polishing compound, scrubbing brushes, nor other hand stuff.
- After cleaning, make sure that the front panel is securely fixed.

## Filters

### 1. Open the front panel. (page 26.)

### 2. Remove the air filter.

- Press the claws on the right and left of the air filter down slightly, then pull upward.

### 3. Take off the Titanium Apatite Photocatalytic Air-Purifying Filter.

- Hold the tabs of the frame, and remove the claws in 4 places.

### 4. Clean or replace each filter.

See figure.

### 5. Set the air filter and Titanium Apatite Photocatalytic Air-Purifying Filter as they were and close the front panel.

- Operation without air filters may result in troubles as dust will accumulate inside the indoor unit.

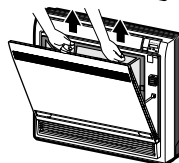
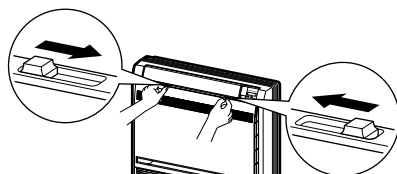

Titanium Apatite Photocatalytic Air-Purifying Filter

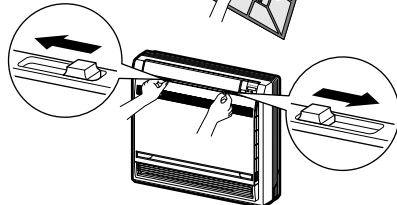

## ■ Air Filter

### 1. Wash the air filters with water or clean them with vacuum cleaner.

- If the dust does not come off easily, wash them with neutral detergent thinned with lukewarm water, then dry them up in the shade.
- It is recommended to clean the air filters every 2 weeks.

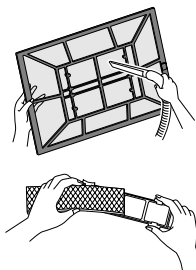

## ■ Titanium Apatite Photocatalytic Air-Purifying Filter

The Titanium Apatite Photocatalytic Air-Purifying Filter can be renewed by washing it with water once every 6 months. We recommend replacing it once every 3 years.

### [ Maintenance ]

1. Vacuum dusts, and soak in warm water or water for about 10 to 15 minutes if dirt is heavy.
2. Do not remove filter from frame when washing with water.
3. After washing, shake off remaining water and dry in the shade.
4. Since the material is made out of paper, do not wring out the filter when removing water from it.

### [ Replacement ]

1. Remove the tabs on the filter frame and replace with a new filter.
  - Dispose of the old filter as flammable waste.

## NOTE

- Operation with dirty filters:  
(1) cannot deodorize the air. (2) cannot clean the air.  
(3) results in poor heating or cooling. (4) may cause odour.
- To order Titanium Apatite Photocatalytic Air-Purifying Filter contact to the service shop there you bought the air conditioner.
- Dispose of old filters as flammable waste.

Item	Part No.
Titanium Apatite Photocatalytic Air-Purifying Filter (without frame) 1 set	KAF968A42

## Check

Check that the base, stand and other fittings of the outdoor unit are not decayed or corroded.
Check that nothing blocks the air inlets and the outlets of the indoor unit and the outdoor unit.
Check that the drain comes smoothly out of the drain hose during COOL or DRY operation. <ul style="list-style-type: none"><li>• If no drain water is seen, water may be leaking from the indoor unit. Stop operation and consult the service shop if this is the case.</li></ul>

## ■ Before a long idle period

- 1. Operate the “FAN only” for several hours on a fine day to dry out the inside.**
  - Press “MODE” button and select “FAN”operation.
  - Press “ON/OFF” button and start operation.
- 2. After operation stops, turn off the breaker for the room air conditioner.**
- 3. Clean the air filters and set them again.**
- 4. Take out batteries from the remote controller.**

## NOTE

- When a multi outdoor unit is connected, make sure the heating operation is not used at the other room before you use the fan operation. (page 24.)

# Trouble Shooting

## These cases are not troubles.

The following cases are not air conditioner troubles but have some reasons. You may just continue using it.

Case	Explanation
<b>Operation does not start soon.</b> <ul style="list-style-type: none"> <li>• When ON/OFF button was pressed soon after operation was stopped.</li> <li>• When the mode was reselected.</li> </ul>	<ul style="list-style-type: none"> <li>• This is to protect the air conditioner. You should wait for about 3 minutes.</li> </ul>
<b>Hot air does not flow out soon after the start of heating operation.</b>	<ul style="list-style-type: none"> <li>• The air conditioner is warming up. You should wait for 1 to 4 minutes. (The system is designed to start discharging air only after it has reached a certain temperature.)</li> </ul>
<b>The heating operation stops suddenly and a flowing sound is heard.</b>	<ul style="list-style-type: none"> <li>• The system is taking away the frost on the outdoor unit. You should wait for about 4 to 12 minutes.</li> </ul>
<b>The outdoor unit emits water or steam.</b>	<ul style="list-style-type: none"> <li>■ In HEAT mode               <ul style="list-style-type: none"> <li>• The frost on the outdoor unit melts into water or steam when the air conditioner is in defrost operation.</li> </ul> </li> <li>■ In COOL or DRY mode               <ul style="list-style-type: none"> <li>• Moisture in the air condenses into water on the cool surface of outdoor unit piping and drips.</li> </ul> </li> </ul>
<b>Mist comes out of the indoor unit.</b>	<ul style="list-style-type: none"> <li>■ This happens when the air in the room is cooled into mist by the cold air flow during cooling operation.</li> <li>■ This is because the air in the room is cooled by the heat exchanger and becomes mist during defrost operation.</li> </ul>
<b>The indoor unit gives out odour.</b>	<ul style="list-style-type: none"> <li>■ This happens when smells of the room, furniture, or cigarettes are absorbed into the unit and discharged with the air flow. (If this happens, we recommend you to have the indoor unit washed by a technician. Consult the service shop where you bought the air conditioner.)</li> </ul>
<b>The outdoor fan rotates while the air conditioner is not in operation.</b>	<ul style="list-style-type: none"> <li>■ After operation is stopped:               <ul style="list-style-type: none"> <li>• The outdoor fan continues rotating for another 60 seconds for system protection.</li> </ul> </li> <li>■ While the air conditioner is not in operation:               <ul style="list-style-type: none"> <li>• When the outdoor temperature is very high, the outdoor fan starts rotating for system protection.</li> </ul> </li> </ul>
<b>The operation stopped suddenly. (OPERATION lamp is on.)</b>	<ul style="list-style-type: none"> <li>■ For system protection, the air conditioner may stop operating on a sudden large voltage fluctuation. It automatically resumes operation in about 3 minutes.</li> </ul>

**Check again.**

Please check again before calling a repair person.

<b>Case</b>	<b>Check</b>
<p><b>The air conditioner does not operate.</b> <b>(OPERATION lamp is off.)</b></p>	<ul style="list-style-type: none"> <li>• Hasn't a breaker turned OFF or a fuse blown?</li> <li>• Isn't it a power failure?</li> <li>• Are batteries set in the remote controller?</li> <li>• Is the timer setting correct?</li> </ul>
<p><b>Cooling (Heating) effect is poor.</b></p>	<ul style="list-style-type: none"> <li>• Are the air filters clean?</li> <li>• Is there anything to block the air inlet or the outlet of the indoor and the outdoor units?</li> <li>• Is the temperature setting appropriate?</li> <li>• Are the windows and doors closed?</li> <li>• Are the air flow rate and the air direction set appropriately?</li> </ul>
<p><b>Operation stops suddenly.</b> <b>(OPERATION lamp flashes.)</b></p>	<ul style="list-style-type: none"> <li>• Are the air filters clean?</li> <li>• Is there anything to block the air inlet or the outlet of the indoor and the outdoor units? Clean the air filters or take all obstacles away and turn the breaker OFF. Then turn it ON again and try operating the air conditioner with the remote controller. If the lamp still flashes, call the service shop where you bought the air conditioner.</li> <li>• Are operation modes all the same for indoor units connected to outdoor units in the <b>multi system</b>? If not, set all indoor units to the same operation mode and confirm that the lamps flash. Moreover, when the operation mode is in "AUTO", set all indoor unit operation modes to "COOL" or "HEAT" for a moment and check again that the lamps are normal. If the lamps stop flashing after the above steps, there is no malfunction. (page 24.)</li> </ul>
<p><b>An abnormal functioning happens during operation.</b></p>	<ul style="list-style-type: none"> <li>• The air conditioner may malfunction with lightning or radio waves. Turn the breaker OFF, turn it ON again and try operating the air conditioner with the remote controller.</li> </ul>

## Call the service shop immediately.

### **WARNING**

- When an abnormality (such as a burning smell) occurs, stop operation and turn the breaker OFF. Continued operation in an abnormal condition may result in troubles, electric shocks or fire. Consult the service shop where you bought the air conditioner.
- Do not attempt to repair or modify the air conditioner by yourself. Incorrect work may result in electric shocks or fire. Consult the service shop where you bought the air conditioner.

If one of the following symptoms takes place, call the service shop immediately.

- **The power cord is abnormally hot or damaged.**
- **An abnormal sound is heard during operation.**
- **The safety breaker, a fuse, or the earth leakage breaker cuts off the operation frequently.**
- **A switch or a button often fails to work properly.**
- **There is a burning smell.**
- **Water leaks from the indoor unit.**



Turn the breaker OFF and call the service shop.

- **After a power failure**  
The air conditioner automatically resumes operation in about 3 minutes. You should just wait for a while.

- **Lightning**  
If lightning may strike the neighbouring area, stop operation and turn the breaker OFF for system protection.

## We recommend periodical maintenance.

In certain operating conditions, the inside of the air conditioner may get foul after several seasons of use, resulting in poor performance. It is recommended to have periodical maintenance by a specialist aside from regular cleaning by the user. For specialist maintenance, contact the service shop where you bought the air conditioner.

The maintenance cost must be born by the user.



# MEMO

## **DAIKIN INDUSTRIES, LTD.**

Head office:

Umeda Center Bldg., 2-4-12, Nakazaki-Nishi,  
Kita-ku, Osaka, 530-8323 Japan

Tokyo office:

JR Shinagawa East Bldg., 2-18-1, Konan,  
Minato-ku, Tokyo, 108-0075 Japan  
<http://www.daikin.com/global/>



Two-dimensional bar code is a code  
for manufacturing.

3P191290-2A M06B130A (0701) HT