









2. Pictographs





2.1 Basic Operation

	<p>■ ON / OFF button Operation starts and stops every time you press the button.</p>
 MODE	<p>■ MODE selector button Operation mode changes everytime you press the button. H/P model : AUTO->DRY->COOL->HEAT->FAN C/O model : DRY->COOL->FAN</p>
	<p>■ AUTO mode display You can set temperature and air flow rate. The system selects an appropriate operation mode based on the room condition at regular interval.</p>
	<p>■ DRY mode display The system controls temperature and air flow rate.</p>
	<p>■ COOL mode display You can set temperature and air flow rate.</p>
	<p>■ HEAT mode display You can set temperature and air flow rate.</p>
	<p>■ FAN mode display You can set air flow rate. The system controls temperature.</p>



2.2 Temperature

	<p>■ Temperature adjust button / Set temperature display Press “▲” to raise the temperature and press “▼” to lower the temperature. The temperature setting is not variable for DRY or FAN mode.</p>
	<p>■ Temperature display switch button You can show the indoor / outdoor temperature on the indoor unit's display.</p>







2.3 Air Flow Rate

	<ul style="list-style-type: none"> ■ Air flow rate adjust button / display Air flow rate changes every time you press the button.
	<ul style="list-style-type: none"> ■ Automatic control of air flow rate (display)
	<ul style="list-style-type: none"> ■ Indoor unit silent operation (display) When the air flow is set to “”, the noise from the indoor unit will become quieter. Use this when making the noise quieter.
	<ul style="list-style-type: none"> ■ 5 levels of air flow rate (display)





2.4 Air Flow Direction

	<ul style="list-style-type: none"> ■ SWING (up & down) button / display The horizontal blades automatically swing.
	<ul style="list-style-type: none"> ■ SWING (right & left) button / display The vertical blades automatically swing.
	<ul style="list-style-type: none"> ■ COMFORT air flow button / display The direction of the flap changes to prevent air from blowing directly on your body.

2.5 Function

	<p>■ POWERFUL operation button / display POWERFUL operation quickly maximizes the cooling (heating) effect in any operation mode. POWERFUL operation ends in 20 minutes. Then the system automatically operates again with the settings which were used before POWERFUL operation.</p>
	<p>■ OUTDOOR UNIT SILENT operation button / display OUTDOOR UNIT SILENT operation lowers the noise level of the outdoor unit by changing the frequency and fan speed on the outdoor unit.</p>
	<p>■ HOME LEAVE operation button / display HOME LEAVE operation is a function which allows you to record your preferred temperature and air flow rate settings.</p>
	<p>■ INTELLIGENT EYE operation button / display “INTELLIGENT EYE” is the infrared sensor which detects the human movement. When the sensor detects nobody for 20min., the system starts energy saving operation.</p>
	<p>■ GOOD-SLEEP COOLING operation button / display The comfortable rhythm “1/f fluctuations” found in nature is adapted. This mode controls the temperatures within a range from the set temperature to a temperature one degree higher than the temperature based on the rhythm “1/f fluctuations” to provide a restful sleep.</p>
	<p>■ ECONO operation button / display ECONO operation is a function which enables efficient operation by lowering the maximum power consumption value.</p>
	<p>■ MOLD PROOF operation MOLD PROOF operation is a function which reduces the spread of mold by using Fan mode to lower the humidity inside the indoor unit.</p>

2.6 Timer

	<ul style="list-style-type: none"> ■ Clock button / display Set the clock with the adjust button “▲” or “▼”.
	<ul style="list-style-type: none"> ■ OFF timer button / display The system switches the operation off at the time you set. ■ NIGHT SET MODE When the OFF TIMER is set, the air conditioner automatically adjusts the temperature setting (0.5°C up in COOL, 2.0°C down in HEAT) to prevent excessive cooling (heating) for your pleasant sleep.
	<ul style="list-style-type: none"> ■ ON timer button / display The system switches the operation on at the time you set.
	<ul style="list-style-type: none"> ■ Timer cancel button

6. ARC433 Series

ARC433A1, A2

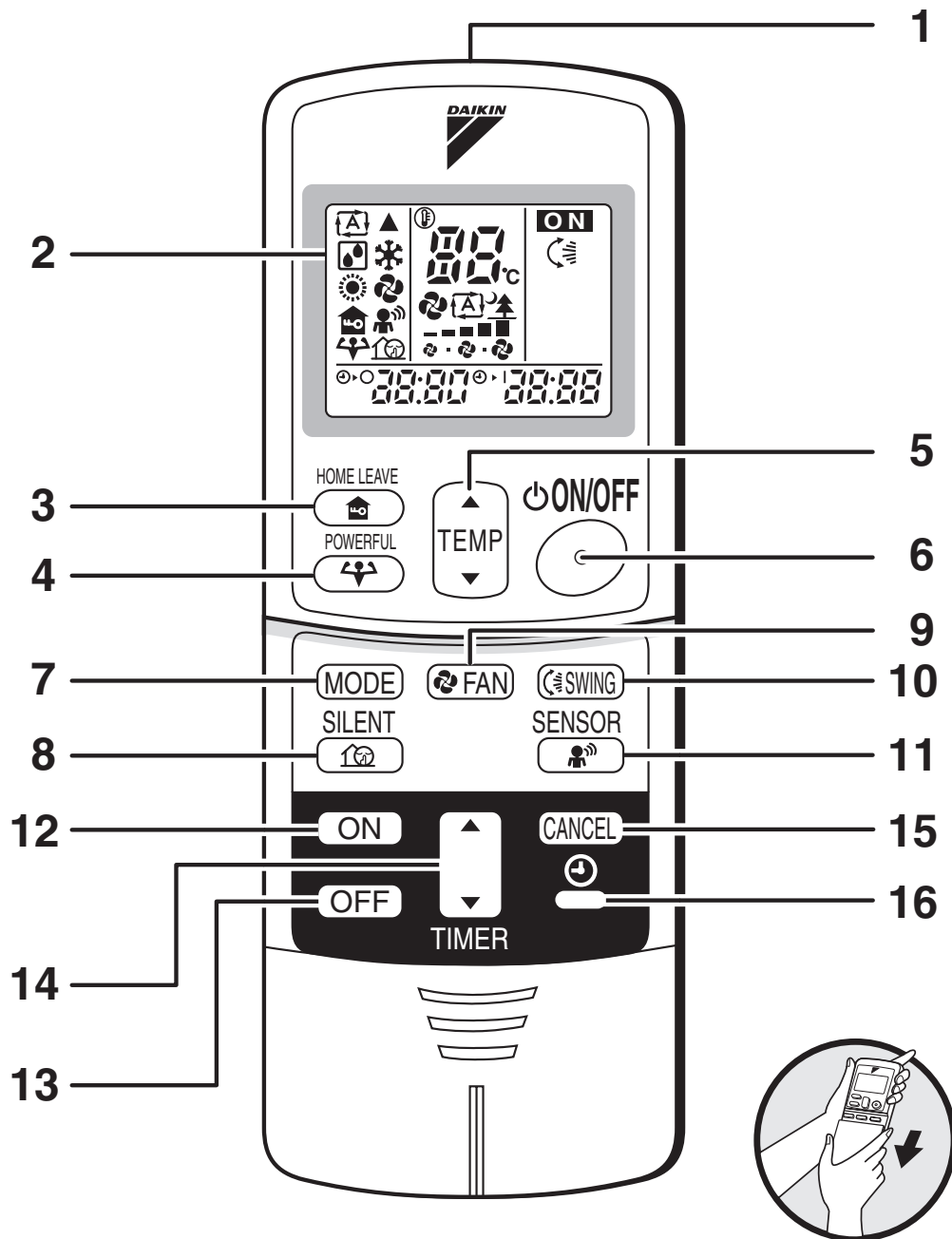

1. Signal transmitter

- It sends signals to the indoor unit.

2. Display

- It displays the current settings. (In this illustration, each section is shown with all its displays ON for the purpose of explanation.)

3. HOME LEAVE button

- for HOME LEAVE operation

4. POWERFUL button

- for POWERFUL operation

5. TEMPERATURE adjustment buttons

- It changes the temperature setting.

6. ON/OFF button

- Press this button once to start operation.
Press once again to stop it.

7. MODE selector button

- It selects the operation mode.
(AUTO/DRY/COOL/HEAT/FAN)

8. SILENT button

- for OUTDOOR UNIT SILENT operation

9. FAN setting button

- It selects the air flow rate setting.

10. SWING button

- 11. **SENSOR button:** for INTELLIGENT EYE operation

12. ON TIMER button**13. OFF TIMER button****14. TIMER Setting button**

- It changes the time setting.

15. TIMER CANCEL button

- It cancels the timer setting.

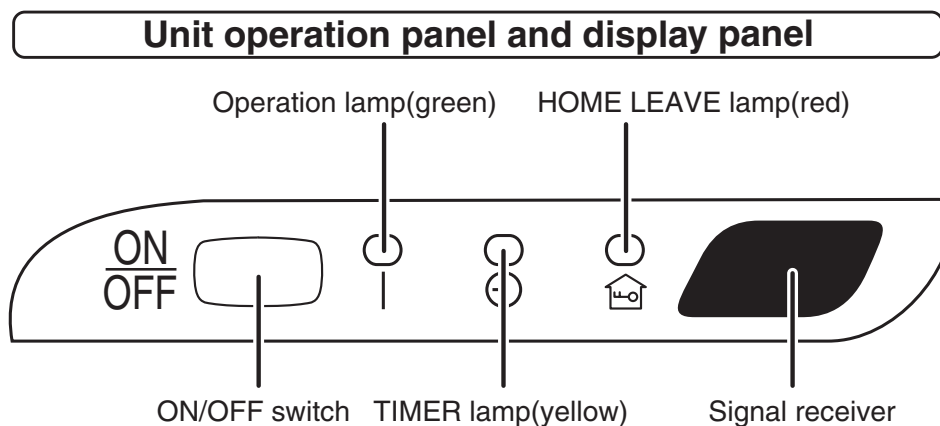
16. CLOCK button

5. ARC433 Series

5.1 Preparation Before Operation

■ To set the batteries

1. Press  with a finger and slide the front cover to take it off.
2. Set two dry batteries (AAA).
3. Set the front cover as before.

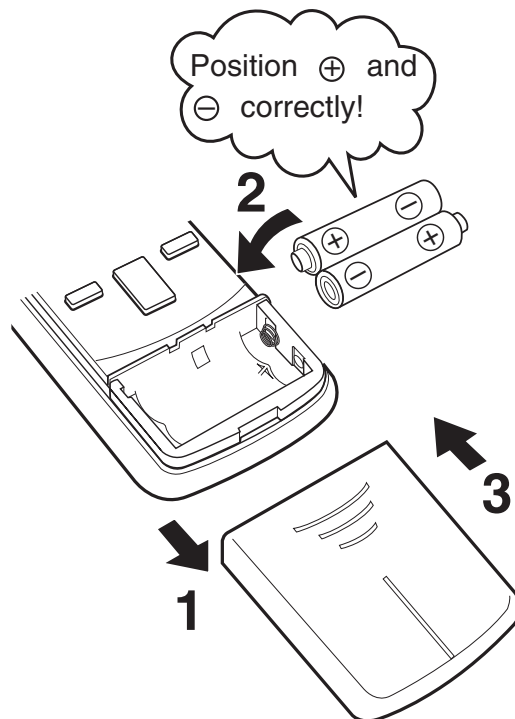

■ To operate the remote controller

- To use the remote controller, aim the transmitter at the indoor unit. If there is anything to block signals between the unit and the remote controller, such as a curtain, the unit will not operate.
- Do not drop the remote controller. Do not get it wet.
- The maximum distance for communication is about 7 m.

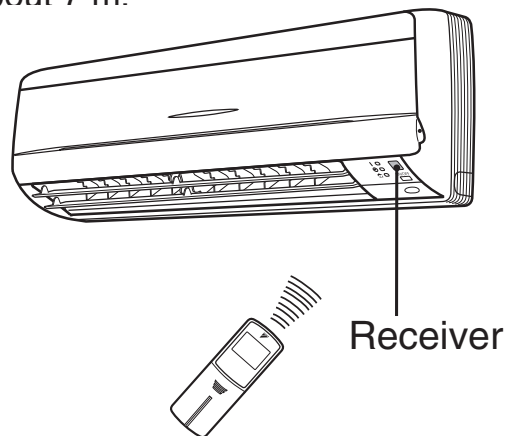

■ To fix the remote controller holder on the wall

1. Choose a place from where the signals reach the unit.
2. Fix the holder to a wall, a pillar, or similar location with the screws procured locally.
3. Place the remote controller in the remote controller holder.

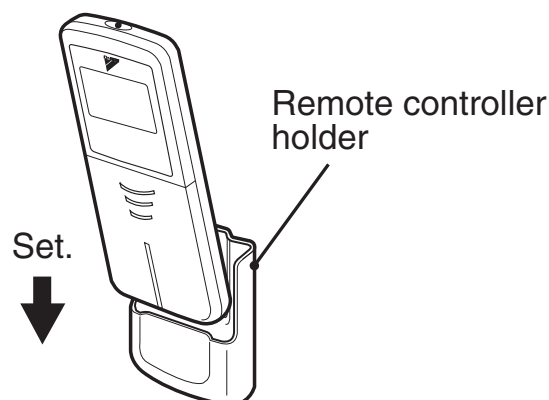

To remove, pull it upwards.

■ To set the clock

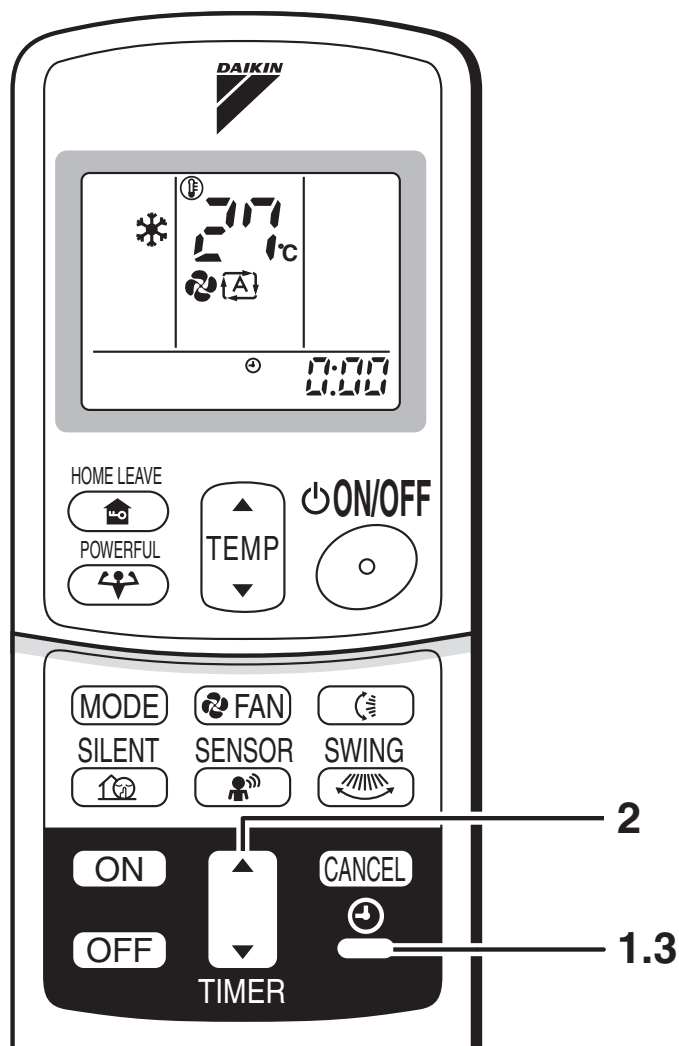

1. Press “CLOCK button”.

0:00 is displayed.

 blinks.

2. Press “TIMER setting button” to set the clock to the present time.

Holding down “▲” or “▼” button rapidly increases or decreases the time display.

3. Press “CLOCK button”.

 blinks.

■ Turn the breaker ON

Turning ON the breaker opens the flap, then closes it again. (This is a normal procedure.)

NOTE

■ Tips for saving energy

- Be careful not to cool (heat) the room too much. Keeping the temperature setting at a moderate level helps save energy.
- Cover windows with a blind or a curtain. Blocking sunlight and air from outdoors increases the cooling (heating) effect.
- Clogged air filters cause inefficient operation and waste energy. Clean them once in about every two weeks.

Recommended temperature setting
For cooling: 26°C – 28°C For heating: 20°C – 24°C

■ Please note

- The air conditioner always consumes 15-35 watts of electricity even while it is not operating.
- If you are not going to use the air conditioner for a long period, for example in spring or autumn, turn the breaker OFF.
- Use the air conditioner in the following conditions.

Mode	Operating conditions	If operation is continued out of this range
COOL	Outdoor temperature: 3/4MK(X)S –10 to 46 °C RK(X)S –10 to 46 °C Indoor temperature: 18 to 32 °C Indoor humidity: 80% max.	· A safety device may work to stop the operation. (In multi system, it may work to stop the operation of the outdoor unit only.) · Condensation may occur on the indoor unit and drip.
HEAT	Outdoor temperature: 3/4MXS –15 to 21 °C RXS –15 to 21 °C Indoor temperature: 10 to 30 °C	· A safety device may work to stop the operation.
DRY	Outdoor temperature: 3/4MK(X)S –10 to 46 °C RK(X)S –10 to 46 °C Indoor temperature: 18 to 32 °C Indoor humidity: 80% max.	· A safety device may work to stop the operation. · Condensation may occur on the indoor unit and drip.

- Operation outside this humidity or temperature range may cause a safety device to disable the system.

5.2 AUTO • DRY • COOL • HEAT • FAN Operation

The air conditioner operates with the operation mode of your choice.

From the next time on, the air conditioner will operate with the same operation mode.

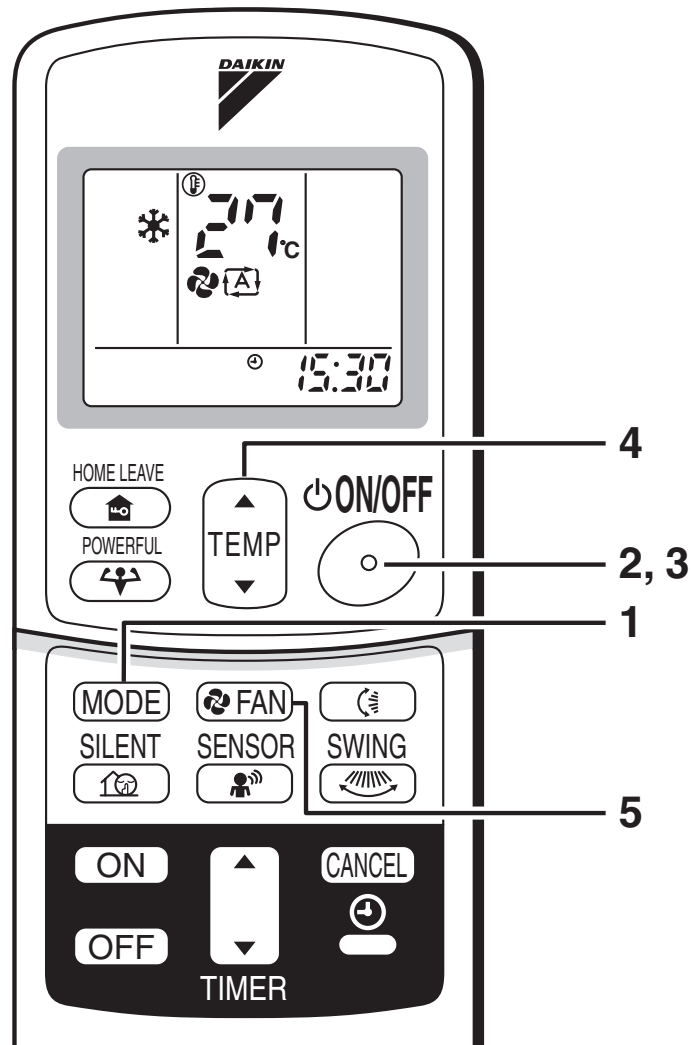

■ To start operation

1. Press “MODE selector button” and select a operation mode.

- Each pressing of the button advances the mode setting in sequence.

: AUTO

: DRY

: COOL

: HEAT

: FAN

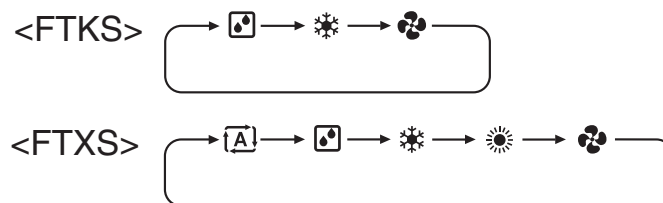

2. Press “ON/OFF button”.

- The OPERATION lamp lights up.

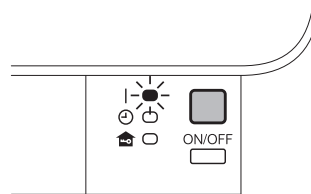

■ To stop operation

3. Press “ON/OFF button” again.

- Then OPERATION lamp goes off.





■ To change the temperature setting

4. Press “TEMPERATURE adjustment button”

DRY or FAN mode	AUTO or COOL or HEAT mode
The temperature setting is not variable.	Press “▲” to raise the temperature and press “▼” to lower the temperature. Set to the temperature you like. 

■ To change the air flow rate setting

5. Press “FAN setting button”.

DRY mode	AUTO or HEAT or COOL or FAN mode
The air flow rate setting is not variable.	Five levels of air flow rate setting from “  ” to “  ” plus “  ” “  ” are available. 

- Indoor unit quiet operation

When the air flow is set to “”, the noise from the indoor unit will become quieter.

Use this when making the noise quieter.

The unit might lose capacity when the air flow rate is set to a weak level.

NOTE

■ Note on HEAT operation

- Since this air conditioner heats the room by taking heat from outdoor air to indoors, the heating capacity becomes smaller in lower outdoor temperatures. If the heating effect is insufficient, it is recommended to use another heating appliance in combination with the air conditioner.
- The heat pump system heats the room by circulating hot air around all parts of the room. After the start of heating operation, it takes some time before the room gets warmer.
- In heating operation, frost may occur on the outdoor unit and lower the heating capacity. In that case, the system switches into defrosting operation to take away the frost.
- During defrosting operation, hot air does not flow out of indoor unit.

■ Note on DRY operation

- The computer chip works to rid the room of humidity while the temperature as much as possible. It automatically controls temperature and fan strength, so manual adjustment of these functions is unavailable.

■ Note on AUTO operation

- In AUTO operation, the system selects a temperature setting and an appropriate operation mode (COOL or HEAT) based on the room temperature at the start of the operation.
- The system automatically reselects setting at a regular interval to bring the room temperature to user-setting level.
- If you do not like AUTO operation, you can manually select the operation mode and setting you like.

■ Note on air flow rate setting



- At smaller air flow rates, the cooling (heating) effect is also smaller.

5.3 Adjusting the Air Flow Direction

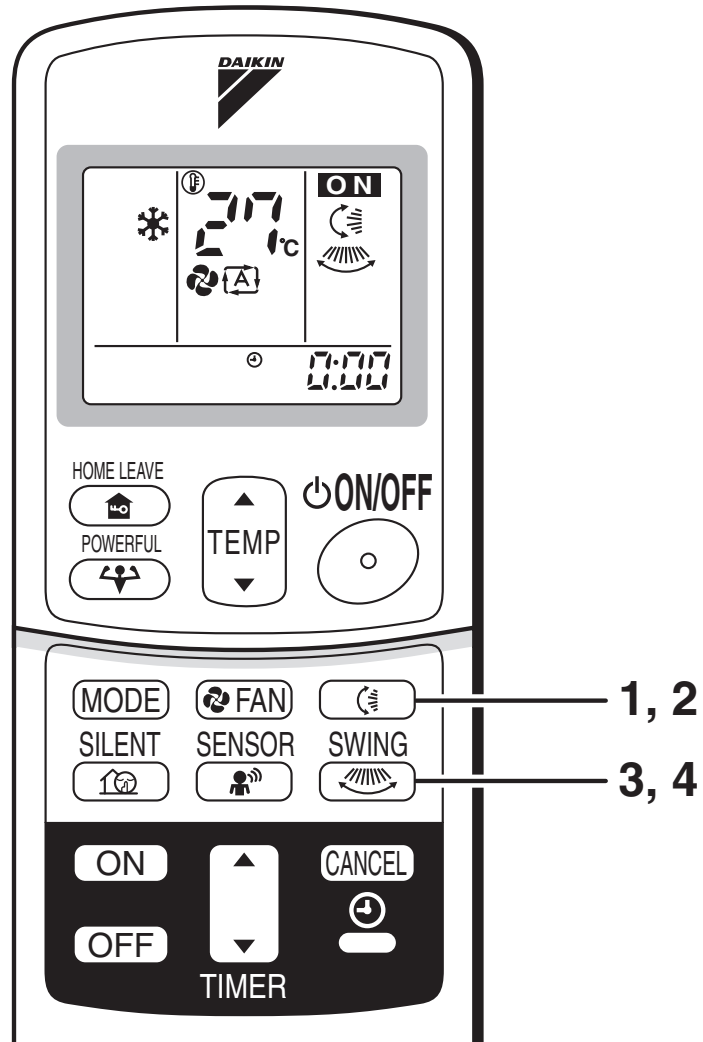

You can adjust the air flow direction to increase your comfort.







■ To adjust the horizontal blade (flap)

1. Press “SWING button ”.
 -  is displayed on the LCD.
2. When the flap has reached the desired position, press “SWING button ” once more.
 - The flap will stop moving.



■ To adjust the vertical blades (louvers)

3. Press “SWING button ”.
 -  is displayed on the LCD.
4. When the louvers have reached the desired position, press the “SWING button ” once more.
 - The louvers will stop moving.

■ To 3-D Airflow

1. 3. Press the “SWING button ” and the “SWING button ”:
the “” and “” display will light up and the flap and louvers will move in turn.

■ To cancel 3-D Airflow

2. 4. Press either the “SWING button ” or the “SWING button ”

Notes on flap angle

- When “**SWING button**” is selected, the flaps swinging range depends on the operation mode. (See the figure.)

Three-Dimensional (3-D) Airflow

- Using three-dimensional airflow circulates cold air, which tends to be collected at the bottom of the room, and hot air, which tends to collect near the ceiling, throughout the room, preventing areas of cold and hot developing.

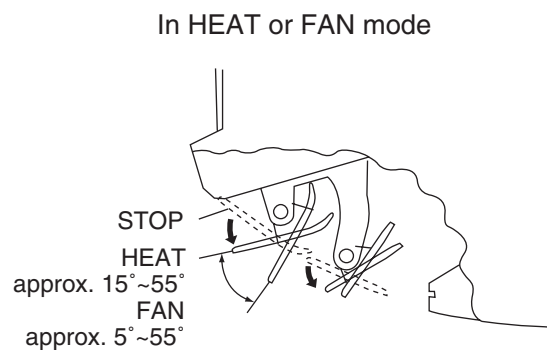
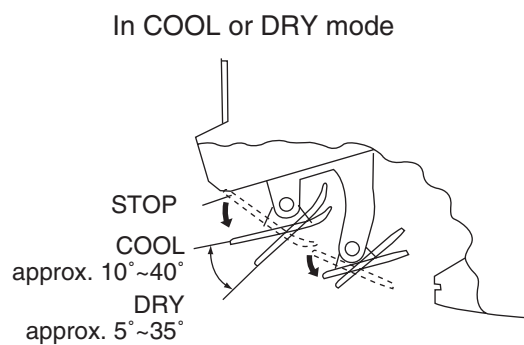

5.4 POWERFUL Operation

POWERFUL operation quickly maximizes the cooling (heating) effect in any operation mode. You can get the maximum capacity.

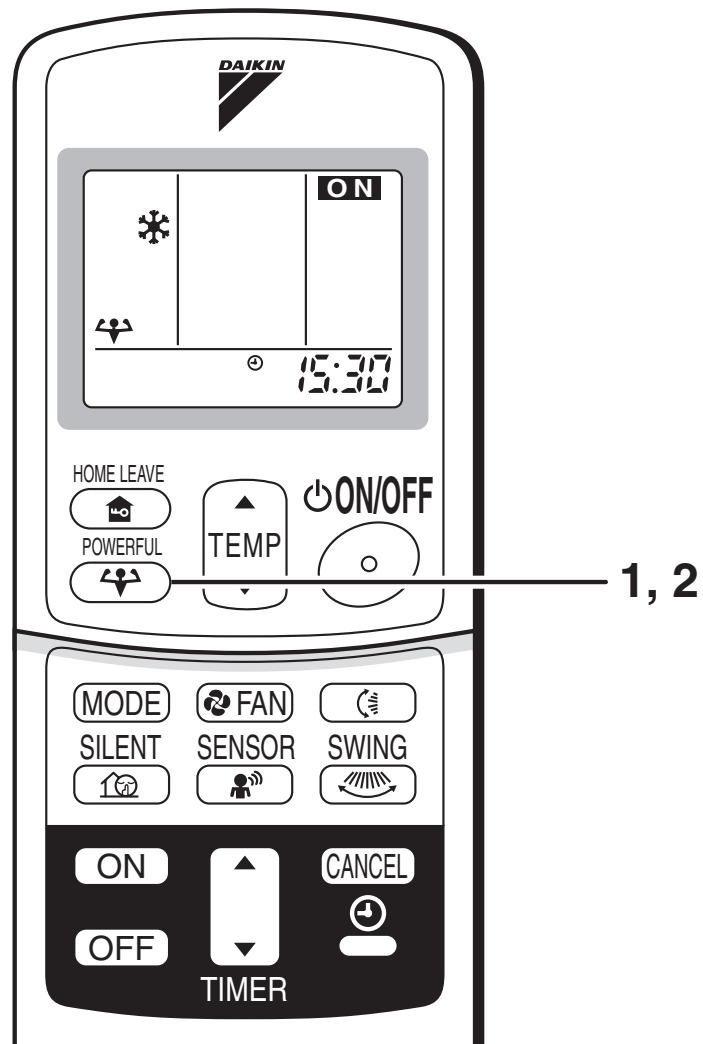

■ To start POWERFUL operation

1. Press “POWERFUL button”.
 - POWERFUL operation ends in 20 minutes. Then the system automatically operates again with the settings which were used before POWERFUL operation.
 - When using Powerful operation, there are some functions which are not available.

■ To cancel POWERFUL operation

2. Press “POWERFUL button” again.

NOTE

■ Notes on POWERFUL operation

- **In COOL and HEAT mode**

To maximize the cooling (heating) effect, the capacity of outdoor unit must be increased and the air flow rate be fixed to the maximum setting. The temperature and air flow settings are not variable.
- **In DRY mode**

The temperature setting is lowered by 2.5°C and the air flow rate is slightly increased.
- **In FAN mode**

The air flow rate is fixed to the maximum setting.
- **When using priority-room setting**

See “Note for multi system”

5.5 OUTDOOR UNIT SILENT Operation

OUTDOOR UNIT SILENT operation lowers the noise level of the outdoor unit by changing the frequency and fan speed on the outdoor unit. This function is convenient during night.

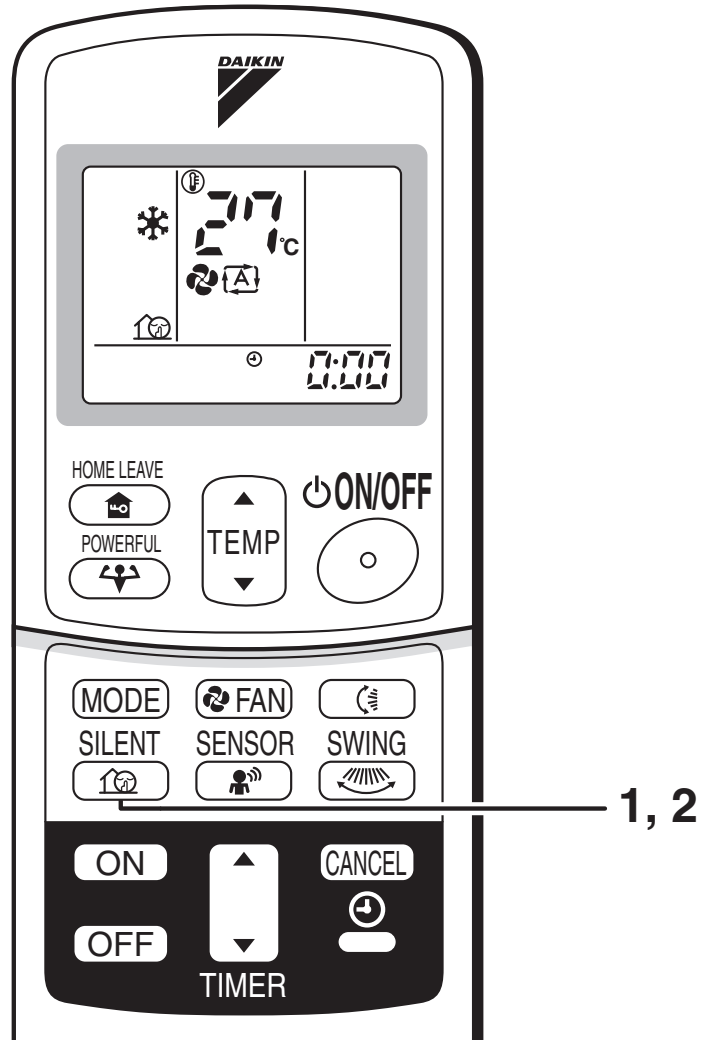

■ To start OUTDOOR UNIT SILENT operation

1. Press “SILENT button”.

■ To cancel OUTDOOR UNIT SILENT operation

2. Press “SILENT button” again.

NOTE

■ Note on OUTDOOR UNIT SILENT operation

- If using a multi system, this function will work only when the OUTDOOR UNIT SILENT operation is set on all operated indoor units. However, if using priority-room setting, see “Note for multi system”
- This function is available in COOL, HEAT, and AUTO modes. (This is not available in FAN and DRY mode.)
- POWERFUL operation and OUTDOOR UNIT SILENT operation cannot be used at the same time. Priority is given to POWERFUL operation. If operation is stopped using the remote control or the main unit ON/OFF switch when using OUTDOOR UNIT SILENT operation, “ ” will remain on the remote controller display.

5.6 HOME LEAVE Operation

HOME LEAVE operation is a function which allows you to record your preferred temperature and air flow rate settings.

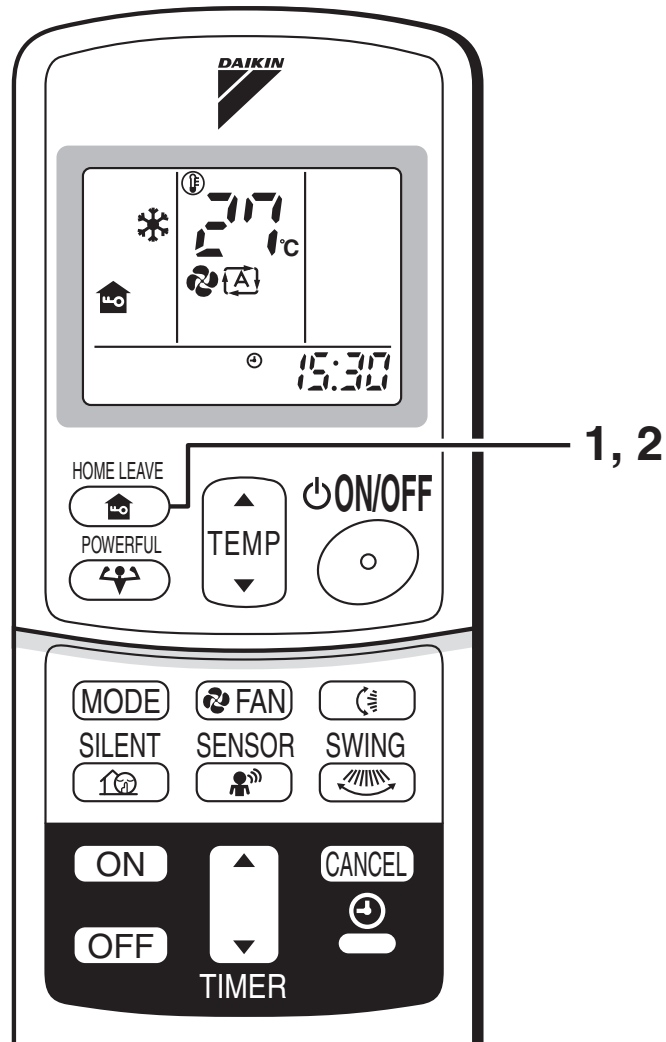

■ To start HOME LEAVE operation

1. Press “HOME LEAVE button”.

- The HOME LEAVE lamp lights up.

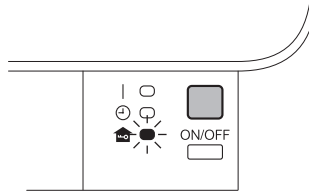

■ To cancel HOME LEAVE operation

2. Press “HOME LEAVE button” again.

- The HOME LEAVE lamp goes off.

Before using HOME LEAVE operation.

■ To set the temperature and air flow rate for HOME LEAVE operation

When using HOME LEAVE operation for the first time, please set the temperature and air flow rate for HOME LEAVE operation. Record your preferred temperature and air flow rate.

	Initial setting		Selectable range	
	temperature	Air flow rate	temperature	Air flow rate
Cooling	25°C	AUTO	18-32°C	5 step, AUTO and SILENT
Heating	25°C	AUTO	10-30°C	5 step, AUTO and SILENT

1. Press “HOME LEAVE button”. Make sure “

Home leave operation will run with these settings the next time you use the unit. To change the recorded information, repeat steps 1 – 3.

■ What’s the HOME LEAVE operation

Is there a set temperature and air flow rate which is most comfortable, a set temperature and air flow rate which you use the most? HOME LEAVE operation is a function that allows you to record your favorite set temperature and air flow rate. You can start your favorite operation mode simply by pressing the HOME LEAVE button on the remote controller. This function is convenient in the following situations.

■ Useful in these cases.

1. Use as an energy-saving mode

Set the temperature 2-3°C higher (cooling) or lower (heating) than normal. Setting the fan strength to the lowest setting allows the unit to be used in energy-saving mode. Also convenient for use while you are out or sleeping.

- **Every day before you leave the house...**

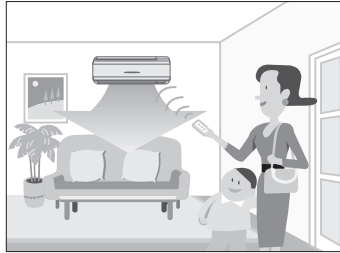

When you go out, push the “HOME LEAVE Operation” button, and the air conditioner will adjust capacity to reach the preset temperature for HOME LEAVE Operation.



When you return, you will be welcomed by a comfortably air conditioned room.

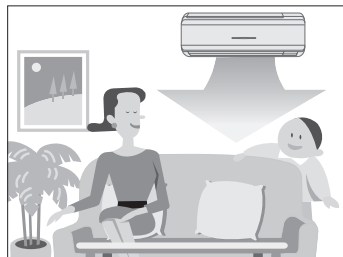

Push the “HOME LEAVE Operation” button again, and the air conditioner will adjust capacity to the set temperature for normal operation.

- **Before bed...**

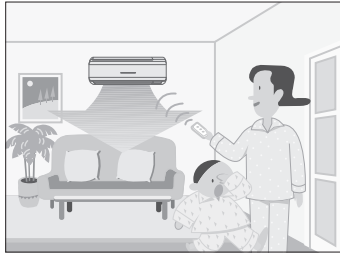

Set the unit to HOME LEAVE Operation before leaving the living room when going to bed.

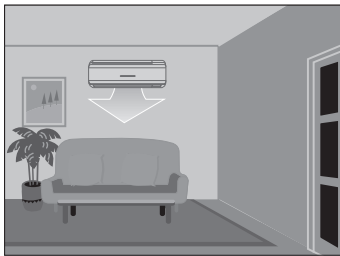

The unit will maintain the temperature in the room at a comfortable level while you sleep.

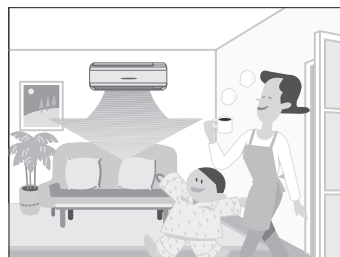

When you enter the living room in the morning, the temperature will be just right. Disengaging HOME LEAVE Operation will return the temperature to that set for normal operation. Even the coldest winters will pose no problem!

2. Use as a favorite mode

Once you record the temperature and air flow rate settings you most often use, you can retrieve them by pressing HOME LEAVE button. You do not have to go through troublesome remote control operations.

NOTE

- Once the temperature and air flow rate for HOME LEAVE operation are set, those settings will be used whenever HOME LEAVE operation is used in the future. To change these settings, please refer to the “Before using HOME LEAVE operation” section above.
- HOME LEAVE operation is only available in COOL and HEAT mode. Cannot be used in AUTO, DRY, and FAN mode.
- HOME LEAVE operation runs in accordance with the previous operation mode (COOL or HEAT) before using HOME LEAVE operation.
- HOME LEAVE operation and POWERFUL operation cannot be used at the same time. Last button that was pressed has priority.
- The operation mode cannot be changed while HOME LEAVE operation is being used.
- When operation is shut off during HOME LEAVE operation, using the remote controller or the indoor unit ON/OFF switch, “” will remain on the remote controller display.

5.7 ECONO Operation

ECONO operation is a function which enables efficient operation by lowering the maximum power consumption value.

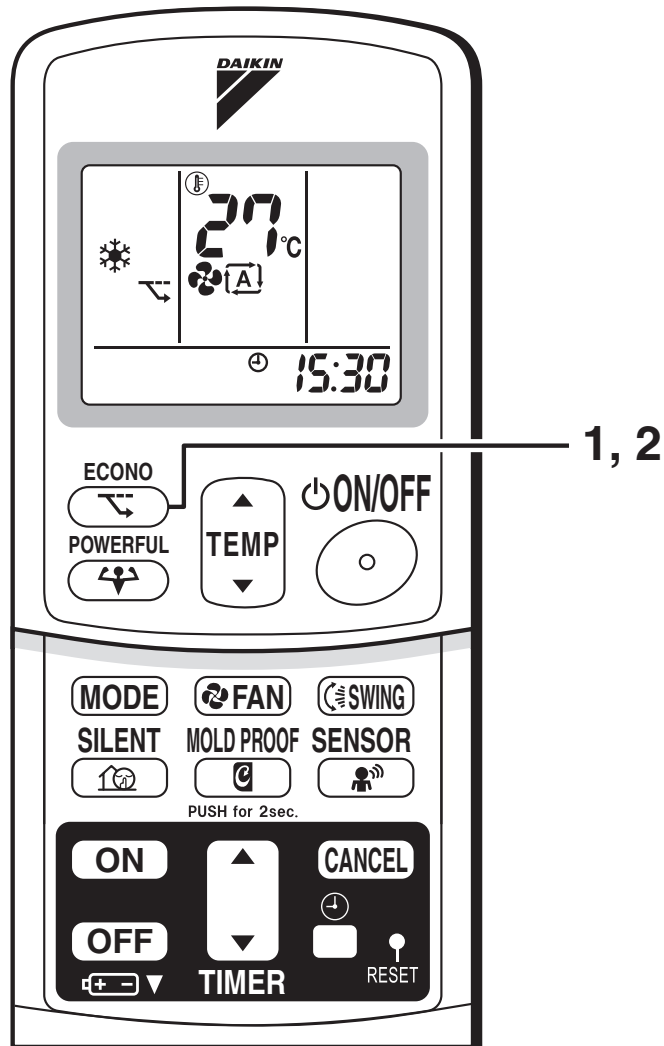

■ To start ECONO operation

1. Press “ECONO button” .

- “” is displayed on the LCD.

■ To cancel ECONO operation

2. Press “ECONO button” again.

- “” disappears from the LCD.

NOTE

- ECONO Operation can only be set when the unit is running. Pressing the operation stop button causes the settings to be canceled, and the “” disappears from the LCD.
- ECONO operation is a function which enables efficient operation by limiting the power consumption of the outdoor unit (operating frequency).
- ECONO operation functions in AUTO, COOL, DRY, and HEAT modes. The fan strength does not change in ECONO operation.
- POWERFUL operation and ECONO operation cannot be used at the same time. Priority is given to POWERFUL operation.
- Power consumption may not drop even if ECONO operation is used, when the level of power consumption is already low.

5.8 MOLD PROOF Operation

MOLD PROOF operation is a function which reduces the spread of mold by using Fan mode to lower the humidity inside the indoor unit.

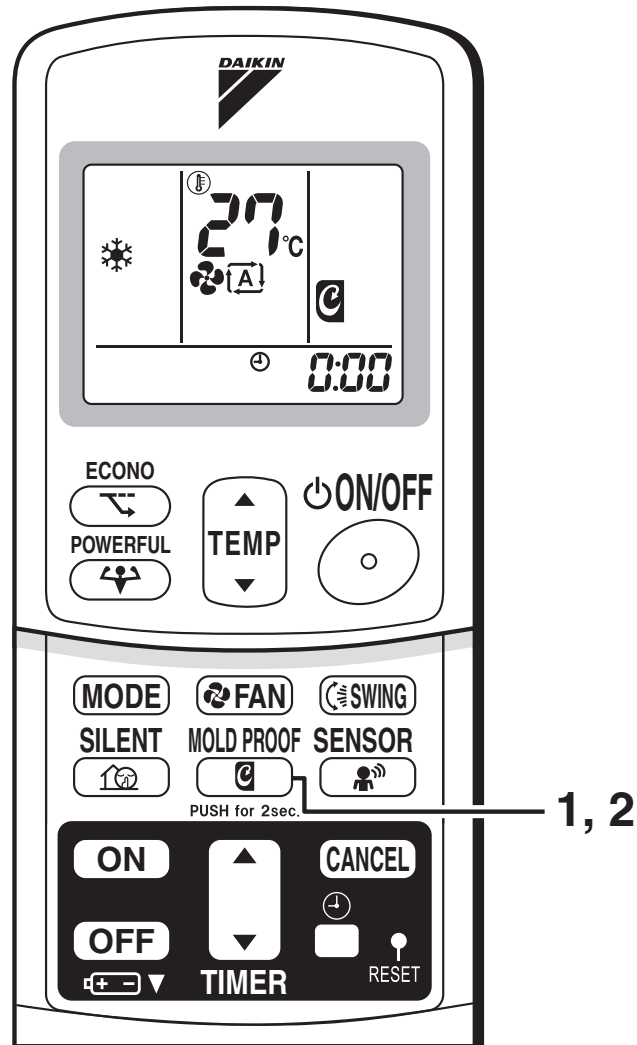

■ To set MOLD PROOF operation

1. Press and hold the MOLD PROOF button for two seconds.
 - “” is displayed on the LCD.

■ To cancel MOLD PROOF operation

2. Press and hold the MOLD PROOF button for two seconds one more time.
 - “” disappears from the LCD.

NOTE

- MOLD PROOF operation will operate for approximately one hour after dry or cooling mode is turned off.
- This function is not designed to remove existing dust or mold.
- MOLD PROOF operation is not available when the unit is turned off using the OFF TIMER.

5.9 INTELLIGENT EYE Operation

“INTELLIGENT EYE” is the infrared sensor which detects the human movement.

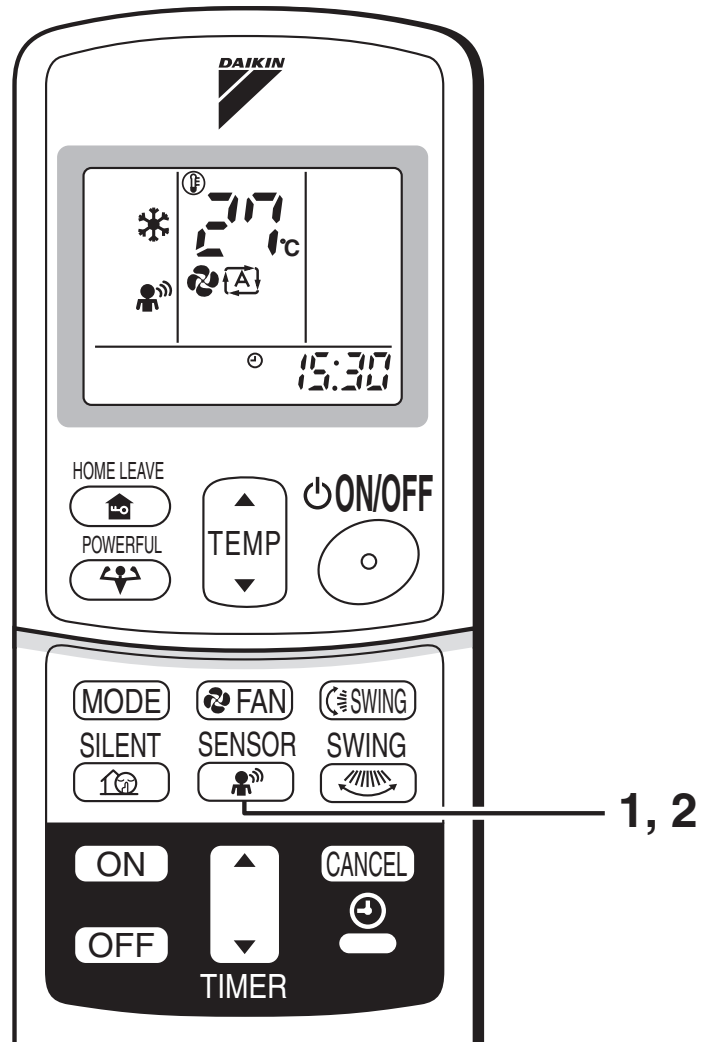

■ To start INTELLIGENT EYE operation

1. Press “SENSOR button”.

■ To cancel the INTELLIGENT EYE operation

2. Press “SENSOR button” again.

[EX.]

When somebody in the room

- Normal operation



When nobody in the room

- 20 min. after, start energy saving operation.



Somebody back in the room

- Back to normal operation.

“INTELLIGENT EYE” is useful for Energy Saving

■ Energy saving operation

- Change the temperature -2°C in heating / $+2^{\circ}\text{C}$ in cooling / $+1^{\circ}\text{C}$ in dry mode from set temperature.
- Decrease the air flow rate slightly in fan operation.
(In FAN mode only)

Notes on “INTELLIGENT EYE”

- Application range is as follows.

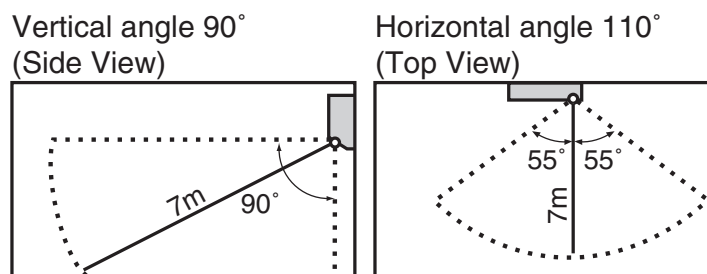

- Sensor may not detect moving objects further than 7m away.
(Check the application range)
- Sensor detection sensitivity changes according to indoor unit location, the speed of passersby, temperature range, etc.
- The sensor also mistakenly detects pets, sunlight, fluttering curtains and light reflected off of mirrors as passersby.
- INTELLIGENT EYE operation will not go on during powerful operation.
- Night set mode will not go on during you use INTELLIGENT EYE operation.

CAUTION

- Do not place large objects near the sensor.
Also keep heating units or humidifiers outside the sensor's detection area. This sensor can detect objects it shouldn't as well as not detect objects it should.
- Do not hit or violently push the INTELLIGENT EYE sensor.
This can lead to damage and malfunction.

5.10 TIMER Operation

Timer functions are useful for automatically switching the air conditioner on or off at night or in the morning. You can also use OFF TIMER and ON TIMER in combination.

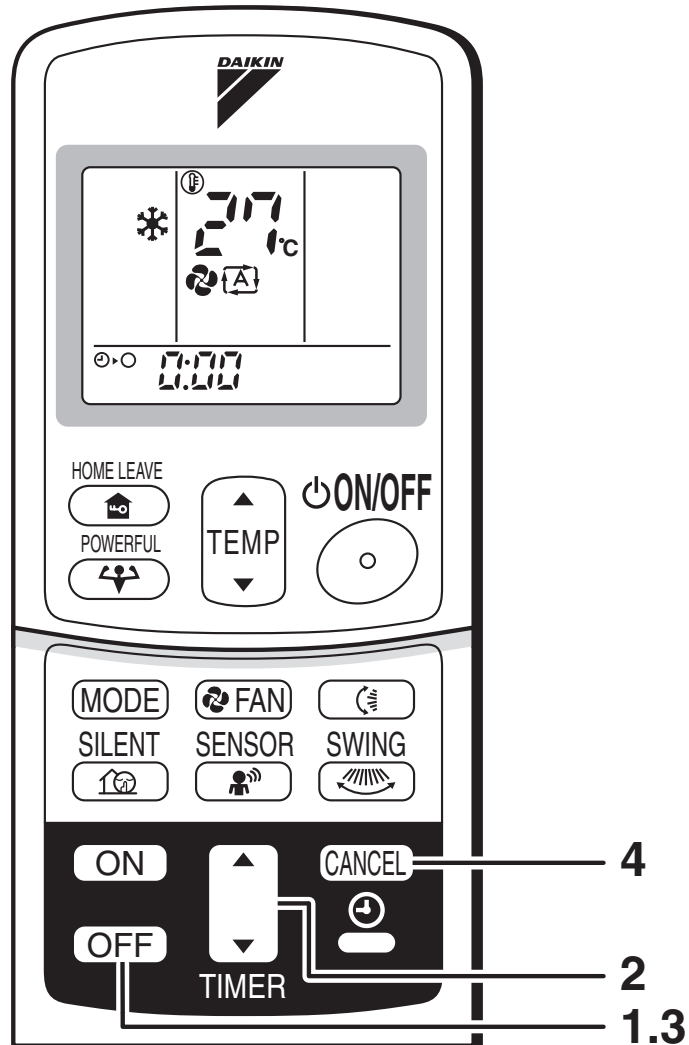

■ To use OFF TIMER operation

- Check that the clock is correct.
If not, set the clock to the present time.

1. Press “OFF TIMER button”.

0:00 is displayed.

⊕-○ blinks.

2. Press “TIMER Setting button” until the time setting reaches the point you like.

- Every pressing of either button increases or decreases the time setting by 10 minutes. Holding down either button changes the setting rapidly.

3. Press “OFF TIMER button” again.

- The TIMER lamp lights up.

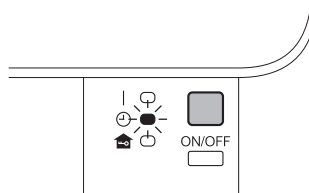

■ To cancel the OFF TIMER Operation

4. Press “CANCEL button”.

- The TIMER lamp goes off.

Notes

- When TIMER is set, the present time is not displayed.
- Once you set ON, OFF TIMER, the time setting is kept in the memory. (The memory is canceled when remote controller batteries are replaced.)
- When operating the unit via the ON/OFF Timer, the actual length of operation may vary from the time entered by the user. (Maximum approx. 10 minutes)

■ NIGHT SET MODE

When the OFF TIMER is set, the air conditioner automatically adjusts the temperature setting (0.5°C up in COOL, 2.0°C down in HEAT) to prevent excessive cooling (heating) for your pleasant sleep.

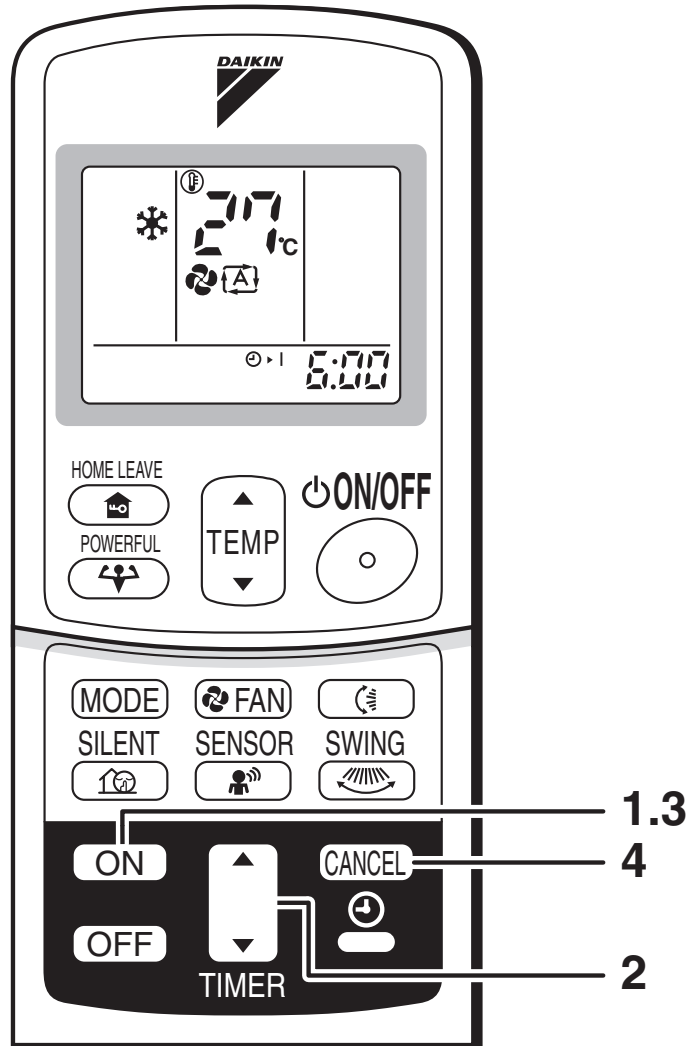

■ To use ON TIMER operation

- Check that the clock is correct. If not, set the clock to the present time

1. Press “ON TIMER button”.

5:00 is displayed.

⊕-| blinks.

2. Press “TIMER Setting button” until the time setting reaches the point you like.

- Every pressing of either button increases or decreases the time setting by 10 minutes. Holding down either button changes the setting rapidly.

3. Press “ON TIMER button” again.

- The TIMER lamp lights up.

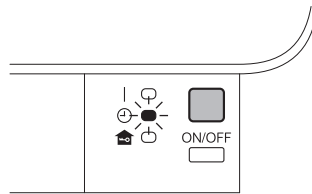

■ To cancel ON TIMER operation

4. Press “CANCEL button”.

- The TIMER lamp goes off.

■ To combine ON TIMER and OFF TIMER

- A sample setting for combining the two timers is shown below.

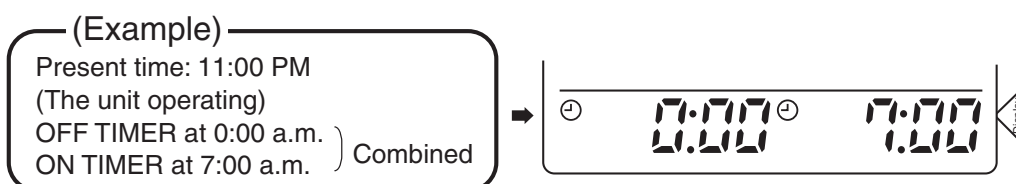

5.11 Note for Multi System

« What is a “Multi System”? »

This system has one outdoor unit connected to multiple indoor units.

■ Selecting the Operation Mode

1. With the Priority Room Setting present but inactive or not present

When more than one indoor unit is operating, priority is given to the first unit that was turned on.

In this case, set the units that are turned on later to the same operation mode (*1) as the first unit.

Otherwise, they will enter the Standby Mode, and the operation lamp will flash; this does not indicate malfunction.

(*1)

- COOL, DRY and FAN mode may be used at the same time.
- AUTO mode automatically selects COOL mode or HEAT mode based on the room temperature.

Therefore, AUTO mode is available when selecting the same operation mode as that of the room with the first unit to be turned on.

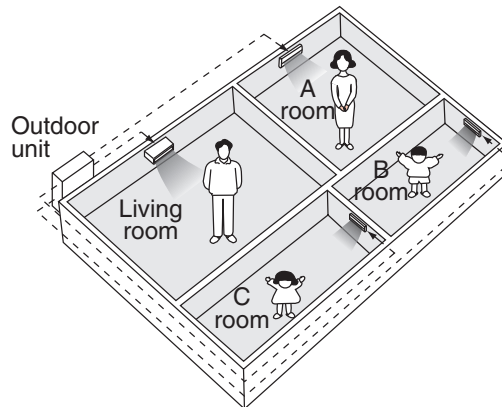

CAUTION

Normally, the operation mode in the room where the unit is first run is given priority, but the following situations are exceptions, so please keep this in mind. If the operation mode of the first room is **FAN Mode**, then using **Heating Mode** in any room after this will give priority to **heating**. In this situation, the air conditioner running in FAN Mode will go on standby, and the operation lamp will flash.

2. With the Priority Room Setting active

See “Priority Room Setting”

■ NIGHT QUIET Mode (Available only for cooling operation)

NIGHT QUIET Mode requires initial programming during installation.

Please consult your retailer or dealer for assistance.

NIGHT QUIET Mode reduces the operation noise of the outdoor unit during the night time hours to prevent annoyance to neighbors.

- The NIGHT QUIET Mode is activated when the temperature drops 5°C or more below the highest temperature recorded that day.
Therefore, when the temperature difference is less than 5°C, this function will not be activated.
- NIGHT QUIET Mode reduces slightly the cooling efficiency of the unit.

■ OUTDOOR UNIT SILENT Operation

1. With the Priority Room Setting present but inactive or not present

When using the OUTDOOR UNIT SILENT operation feature with the Multi system, set all indoor units to OUTDOOR UNIT SILENT operation using their remote controllers.

When clearing OUTDOOR UNIT SILENT operation, clear one of the operating indoor units using their remote controller.

However OUTDOOR UNIT SILENT operation display remains on the remote controller for other rooms.

We recommend you release all rooms using their remote controllers.

2. With the Priority Room Setting active

See "Priority Room Setting" on the next page.

■ Cooling / Heating Mode Lock (Available only for heat pump models)

The Cooling / Heating Mode Lock requires initial programming during installation. Please consult your retailer or dealer for assistance. The Cooling / Heating Mode Lock sets the unit forcibly to either Cooling or Heating Mode.

This function is convenient when you wish to set all indoor units connected to the Multi system to the same operation mode.

■ Priority Room Setting

The Priority Room Setting requires initial programming during installation. Please consult your retailer or dealer for assistance.

The room designated as the Priority Room takes priority in the following situations;

1. Operation Mode Priority

As the operation mode of the Priority Room takes precedence, the user can select a different operation mode from other rooms.

<Example>

* Room A is the Priority Room in the examples.

When COOL mode is selected in Room A while operating the following modes in Room B,C and D:

Operation mode in Room B, C and D	Status of Room B, C and D when the unit in Room A is in COOL mode
COOL or DRY or FAN	Current operation mode maintained
HEAT	The unit enters Standby Mode. Operation resumes when the Room A unit stops operating.
AUTO	If the unit is set to COOL mode, operation continues. If set to HEAT mode, it enters Standby Mode. Operation resumes when the Room A unit stops operating.

2. Priority when POWERFUL operation is used

Example

* Room A is the Priority Room in the examples.

The indoor units in Rooms A,B,C and D are all operating.

If the unit in Room A enters POWERFUL operation, operation capacity will be concentrated in Room A. In such a case, the cooling (heating) efficiency of the units in Rooms B,C and D may be slightly reduced.

3. Priority when using OUTDOOR UNIT SILENT operation

Example

* Room A is the Priority Room in the examples.

Just by setting the unit in Room A to SILENT operation, the air conditioner starts OUTDOOR UNIT SILENT operation.

You don't have to set all the operated indoor units to SILENT operation.