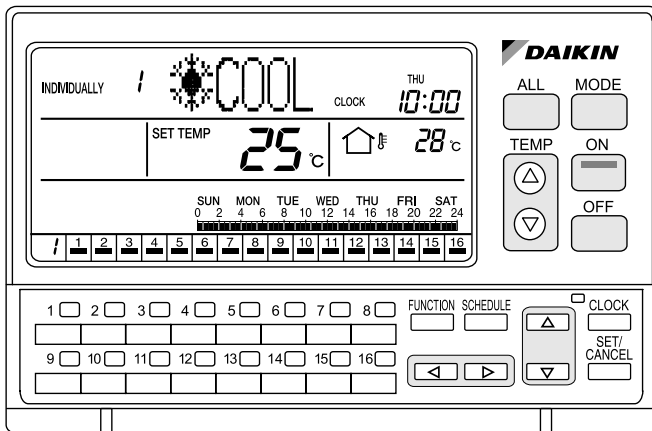

RESIDENTIAL CENTRAL REMOTE CONTROLLER

MODELS

DCS303A51

CONTENTS

PRE-OPERATION CHECK AND PRE-CAUTIONS

SAFETY CONSIDERATIONS.....	1
SYSTEM OVERVIEW.....	4
NAMES AND FUNCTIONS OF THE OPERATING SECTION.....	5

SCREENS

HOW TO DISPLAY THE ALL SCREEN.....	6
HOW TO DISPLAY THE INDIVIDUALLY SCREEN ..	7

OPERATION

HOW TO TURN ALL UNITS ON OR OFF SIMULTANEOUSLY	8
HOW TO TURN UNITS ON OR OFF INDIVIDUALLY.....	9
HOW TO CHANGE THE OPERATION MODE.....	10
HOW TO ADJUST THE SET TEMPERATURE	11

FUNCTIONS

OPERATION CODE.....	12
RESET FILTER SIGN.....	15
OUTDOOR TEMPERATURE DISPLAY	17
DAYLIGHT SAVING.....	18
HOW TO SET A DAYLIGHT SAVING PERIOD.....	20
CONTRAST SETTING.....	27
KEY LOCK SETTING.....	28
SCHEDULE SETTING	30
SCHEDULE SETTING - "OFF DAY" SETTING	33
SCHEDULE SETTING: COPY PREV DAY'S SETTING.....	36
SCHEDULE SETTING: CLEAR TIMER.....	38
CURRENT TIME SETTING	40
STANDBY MODE	41
OUTDOOR TEMPERATURE DISPLAY	42
ERROR DIAGNOSTIC FUNCTION	44
COOLING/HEATING PRIVILEGE SETTING	47

USEFUL INFORMATION

SPECIFICATIONS	48
AFTER-SALE SERVICE	49

SAFETY CONSIDERATIONS

To gain full advantage of the air conditioner's functions and to avoid malfunction due to mishandling, we recommend that you read this instruction manual carefully before use.

This air conditioner is classified under "appliances not accessible to the general public".

The precautions described herein are classified as **WARNING** and **CAUTION**. They both contain important information regarding safety. Be sure to observe all precautions without fail.

 **WARNING** Failure to follow these instructions properly may result in personal injury or loss of life.

 **CAUTION** Failure to observe these instructions properly may result in property damage or personal injury, which may be serious depending on the circumstances.

After reading, keep this manual in a convenient place so that you can refer to it whenever necessary. If the equipment is transferred to a new user, be sure also to hand over the manual.

 **WARNING**

Be aware that prolonged, direct exposure to cool or warm air from the air conditioner, or to air that is too cool or too warm can be harmful to your physical condition and health.

When the air conditioner is malfunctioning (giving off a burning odour, etc.) turn off power to the unit and contact your local dealer.

Continued operation under such circumstances may result in a failure, electric shocks or fire hazards.

Consult your local dealer to install your equipment. Doing the work yourself may result in water leakage, electric shocks or fire hazards.

Consult your local dealer regarding modification, repair and maintenance of the air conditioner or the remote controller.

Improper workmanship may result in water leakage, electric shocks or fire hazards.

Do not place objects, including rods, your fingers, etc., in the air inlet or outlet.

Injury may result due to contact with the air conditioner's highspeed fan blades.

Beware of fire in case of refrigerant leakage.

If the air conditioner is not operating correctly, i.e. not generating cool or warm air, refrigerant leakage could be the cause.

Consult your dealer for assistance.

The refrigerant within the air conditioner is safe and normally does not leak.

However, in the event of a leakage, contact with a naked burner, heater or cooker may result in generation of noxious gas.

Do not longer use the air conditioner until a qualified service person confirms that the leakage has been repaired.

Consult your local dealer regarding what to do in case of refrigerant leakage.

When the air conditioner is to be installed in a small room, it is necessary to take proper measures so that the amount of any leaked refrigerant does not exceed the concentration limit in the event of a leakage. Otherwise, this may lead to an accident due to oxygen depletion.

Contact professional personnel about attachment of accessories and be sure to use only accessories specified by the manufacturer.

If a defect results from your own workmanship, it may result in water leaks, electric shock or fire.

Consult your local dealer regarding relocation and reinstallation of the air conditioner.

Improper installation work may result in leakage, electric shocks or fire hazards.

Be sure to use fuses with the correct ampere reading.

Do not use improper fuses, copper or other wires as a substitute, as this may result in electric shock, fire, injury or damage to the unit.

Be sure to install an earth leakage breaker.

Failure to install an earth leakage breaker may result in electric shocks or fire.

Be sure to earth the unit.

Do not earth the unit to a utility pipe, lightning conductor or telephone earth lead. Imperfect earthing may result in electric shocks or fire.

A high surge current from lightning or other sources may cause damage to the air conditioner.

Consult the dealer if the air conditioner submerges owing to a natural disaster, such as a flood or typhoon.

Do not operate the air conditioner in that case, or otherwise a malfunction, electric shock, or fire may result.

Do not start or stop operating the air conditioner with the power supply breaker turned ON or OFF.

Otherwise, fire or water leakage may result. Furthermore, the fan will rotate abruptly if power failure compensation is enabled, which may result in injury.

Do not use the product in the atmosphere contaminated with oil vapor, such as cooking oil or machine oil vapor.

Oil vapor may cause crack damage, electric shocks, or fire.

Do not use the product in places with excessive oily smoke, such as cooking rooms, or in places with flammable gas, corrosive gas, or metal dust.

Using the product in such places may cause fire or product failures.

Do not use flammable materials (e.g., hairspray or insecticide) near the product.

Do not clean the product with organic solvents such as paint thinner.

The use of organic solvents may cause crack damage to the product, electric shocks, or fire.

Be sure to use a dedicated power supply for the air conditioner.

The use of any other power supply may cause heat generation, fire, or product failures.

 **CAUTION**

Do not use the air conditioner for purposes other than those for which it is intended.

Do not use the air conditioner for cooling precision instruments, food, plants, animals or works of art as this may adversely affect the performance, quality and/or longevity of the object concerned.

Do not remove the outdoor unit's fan guard.

The guard protects against the unit's high speed fan, which may cause injury.

Do not place objects that are susceptible to moisture directly beneath the indoor or outdoor units.

Under certain conditions, condensation on the main unit or refrigerant pipes, air filter dirt or drain blockage may cause dripping, resulting in fouling or failure of the object concerned.

To avoid oxygen depletion, ensure that the room is adequately ventilated if equipment such as a burner is used together with the air conditioner.

After prolonged use, check the unit stand and its mounts for damage.

If left in a damaged condition, the unit may fall and cause injury.

Do not place flammable sprays or operate spray containers near the unit as this may result in fire.

Before cleaning, be sure to stop unit operation, turn the breaker off or remove the power cord.

Otherwise, an electric shock and injury may result.

To avoid electric shocks, do not operate with wet hands.

Do not place appliances that produce naked flames in places exposed to the airflow from the unit as this may impair combustion of the burner.

Do not place heaters directly below the unit, as resulting heat can cause deformation.

Do not allow a child to mount on the outdoor unit or avoid placing any object on it.

Falling or tumbling may result in injury.

Do not block air inlets nor outlets.

Impaired airflow may result in insufficient performance or trouble.

Be sure that children, plants or animals are not exposed directly to airflow from the unit, as adverse effects may ensue.

Do not wash the air conditioner or the remote controller with water, as this may result in electric shocks or fire.

Do not place water containers (flower vases, etc.) on the unit, as this may result in electric shocks or fire.

Do not install the air conditioner at any place where there is a danger of flammable gas leakage.

In the event of a gas leakage, build-up of gas near the air conditioner may result in fire hazards.

Do not put flammable containers, such as spray cans, within 1 m from the blow-off mouth.

The containers may explode because the warm air output of the indoor or outdoor unit will affect them.

The batteries must be removed from the appliance before it is scrapped and they are disposed of safely.

Arrange the drain hose to ensure smooth drainage.

Imperfect drainage may cause wetting.

The appliance is not intended for use by unattended young children or infirm persons.

Impairment of bodily functions and harm to health may result.

Children should be supervised to ensure that they do not play with the unit or its remote controller.

Accidental operation by a child may result in impairment of bodily functions and harm health.

Do not let children play on or around the outdoor unit.

If they touch the unit carelessly, injury may be caused.

Consult your dealer regarding cleaning the inside of the air conditioner.

Improper cleaning may cause breakage of plastic parts, water leakage and other damage as well as electric shocks.

To avoid injury, do not touch the air inlet or aluminium fins of the unit.

Do not place objects in direct proximity of the outdoor unit and do not let leaves and other debris accumulate around the unit.

Leaves are a hotbed for small animals which can enter the unit. Once in the unit, such animals can cause malfunctions, smoke or fire when making contact with electrical parts.

Never touch the internal parts of the controller.

Do not remove the front panel. Touching certain internal parts will cause electric shocks and damage to the unit. Please consult your dealer about checking and adjustment of internal parts.

Do not leave the remote controller wherever there is a risk of wetting.

If water gets into the remote controller there is a risk of electrical leakage and damage to electronic components.

Watch your steps at the time of air filter cleaning or inspection.

High-place work is required, to which utmost attention must be paid.

If the scaffold is unstable, you may fall or topple down, thus causing injury.

SYSTEM OVERVIEW

This central remote controller can monitor and control up to 16 “indoor unit groups”.

By using eight units of this central remote controller, maximum of 128 “indoor unit groups” can be monitored and controlled.

Main Functions

1. Simultaneous ON/OFF control of all indoor units connected to the central remote controller.
2. Setting of operating conditions (such as ON/OFF and set temperature) of indoor units individually by “group”.
3. Monitoring of operating conditions such as operation mode and set temperature.
4. Connection of an external key system, central monitoring panel, etc. via Forced OFF input (T1, T2).

- When using one central remote controller unit

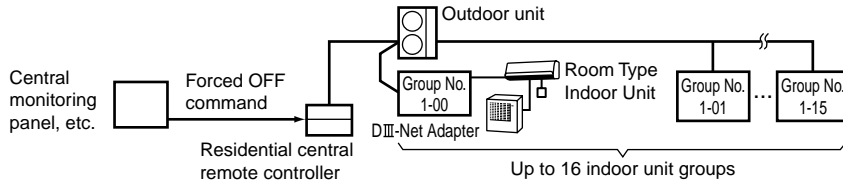

- When using eight central remote controller units

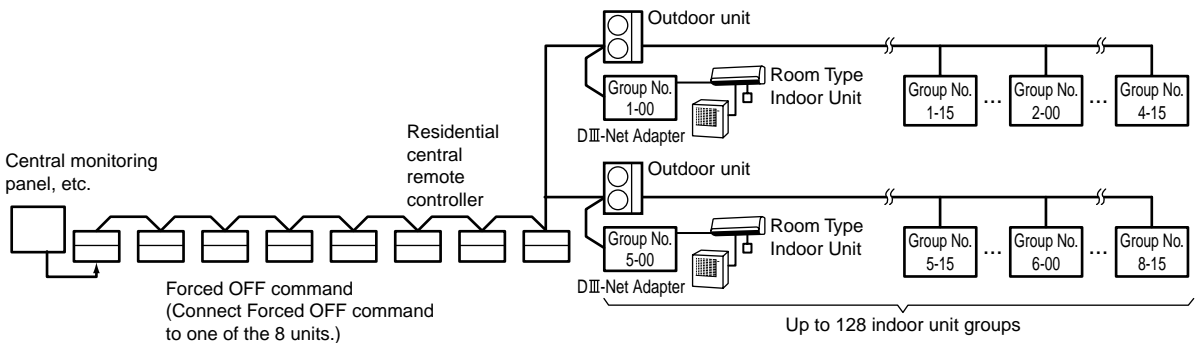

(The central remote controller cannot be used together with the optional remote control adaptor PCB or group remote control adaptor.)

* An “indoor unit group” refers to one of the following:

1. One indoor unit without remote controller

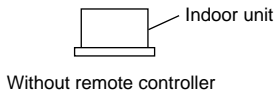

2. One indoor unit controlled by one or two remote controllers



3. Up to 16 indoor units group-controlled by one or two remote controllers

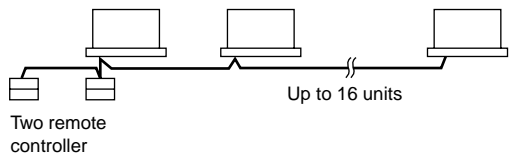
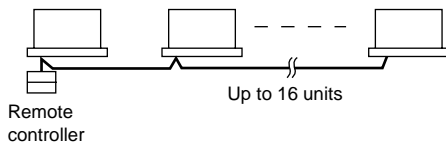

* “Group control” is a setting which enables simultaneous control of multiple indoor units from a single remote controller.

NAMES AND FUNCTIONS OF THE OPERATING SECTION

External View

(All indications are displayed in the following diagram of screen for the explanation purpose. Actual indications displayed during operation will vary.)

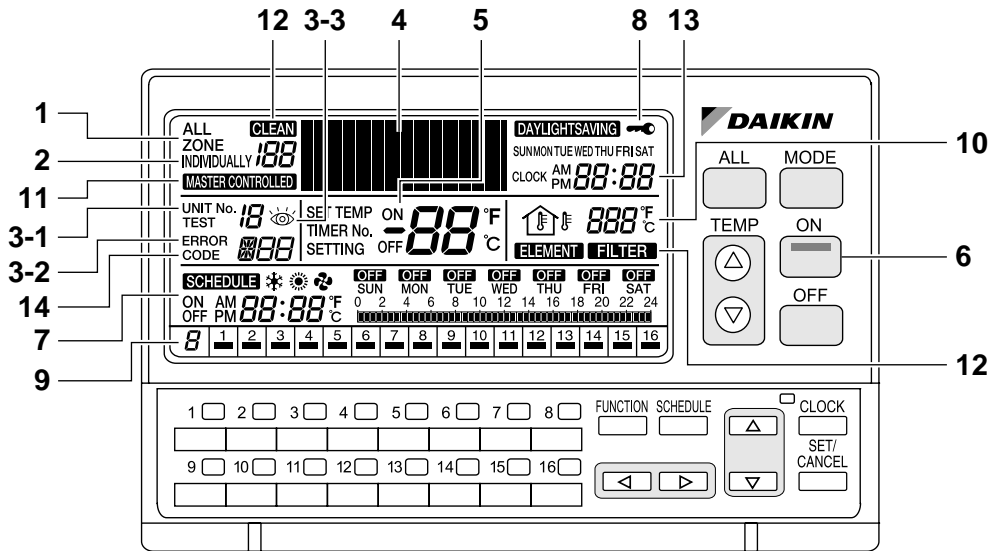

1	ALL This indicates that the display shows the ALL screen.
2	INDIVIDUALLY This indicates that the display shows the INDIVIDUALLY screen for the currently selected air conditioner No.
3	ERROR CODE DISPLAY When an equipment malfunction occurs, the malfunction UNIT No. (3-1), ERROR CODE (3-2) and (3-3) indications blink.
4	OPERATION MODE DISPLAY (Dot Matrix) This section displays the operation status.
5	SET TEMP DISPLAY This section displays the set temperature.
6	ON LAMP This lamp lights when one or more indoor units under control are operating.
7	SCHEDULE SETTING DISPLAY This section displays the programmed operation details.
8	KEY LOCK DISPLAY This symbol appears when the key lock has been activated.
9	OPERATION MONITOR Each box shows the No. of connected air conditioner (group) and its operation status.

10	OUTDOOR TEMP DISPLAY In the ALL screen, this displays the outside temperature detected by the outdoor unit connected to the air conditioner (group) with a cooling/heating selection privilege(*) that has the smallest unit No. In the INDIVIDUALLY screen, this displays the outside temperature detected by the outdoor unit connected to the selected air conditioner (group). If Total Heat Exchanger is selected, outdoor temperature is not displayed. (*An air conditioner (group) with a cooling/heating selection privilege is a unit which allows switching of the operation mode between cooling and heating.)
11	MASTER-CONTROLLED DISPLAY This indication appears when the selected air conditioner (group) does not have a cooling/heating selection privilege.
12	CLEAN SIGN The FILTER and ELEMENT indications appear when the filter and element need to be cleaned.
13	CLOCK DISPLAY This shows the current time.
14	OPERATION CODE DISPLAY This displays the operation code (prohibit remote controller, central control priority, last button priority, etc.) during the setting of operation details.

NAMES AND FUNCTIONS OF THE OPERATING SECTION

■ Names of Operation Buttons

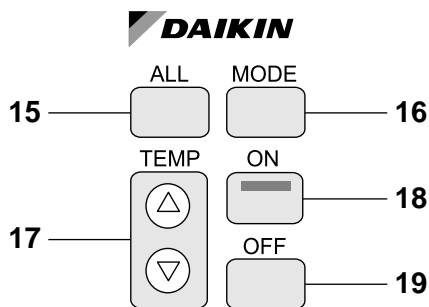

15	ALL BUTTON
	Changes the display to the ALL screen.
16	MODE BUTTON
	Used to select the operation mode.
17	TEMP BUTTONS
	Used to set the temperature.
18	ON BUTTON
	Turns on all indoor units or individual unit (group).
19	OFF BUTTON
	Stops all indoor units or individual unit (group).

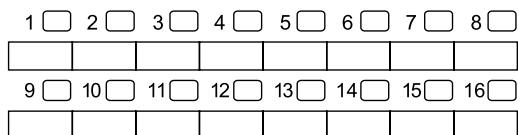

20

20	INDIVIDUAL UNIT (GROUP) SELECTION BUTTONS
	Changes the display to the INDIVIDUALLY screen for monitoring or setting the air conditioner (group) of the indicated No.

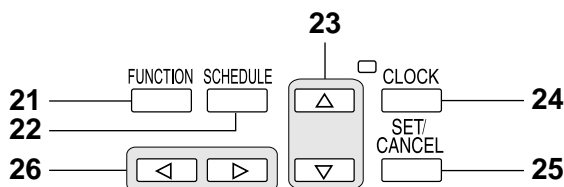

21	FUNCTION BUTTON
	Changes the display to the Function Menu setting screen.
22	SCHEDULE BUTTON
	Changes the display to the SCHEDULE setting screen.

23	△▽ BUTTONS
	Used to select a menu.
24	CLOCK BUTTON
	Changes the display to the current time setting screen.
25	SET/CANCEL BUTTON
	Enters or cancels settings.
26	<▷> BUTTONS
	Used to set an operation schedule or current time.

HOW TO DISPLAY THE ALL SCREEN

■ Displaying the ALL screen

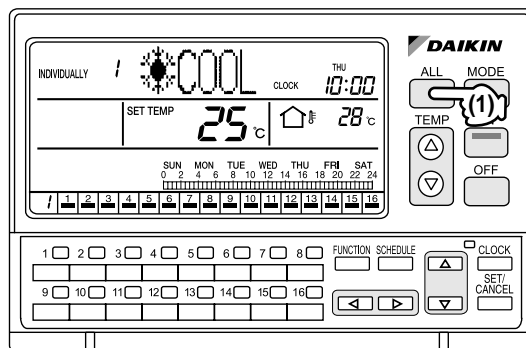

[Operating Procedure]

Press the ALL button (1).

When one or more connected air conditioners (groups) are operating, if no button is operated for 20 seconds, the display changes to the INDIVIDUALLY screen. If all air conditioners are in non-operation, the display does not change to the INDIVIDUALLY screen.

NOTE

Operate buttons while the backlights are lit.

[Screen Display]

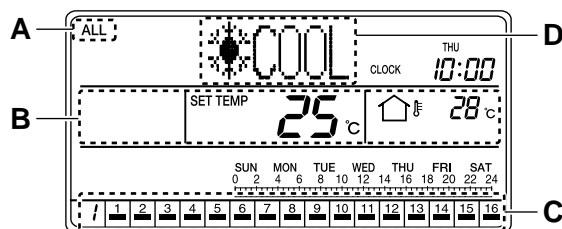

A. The ALL screen appears, and "ALL" is indicated at the upper left corner of the screen.

B. This section displays the operation information of the air conditioner in operation that has the smallest unit No. in the air conditioners (groups) with cooling/heating selection privilege.

- C. This section displays the Nos. of all connected air conditioners (groups).
The ■■■■ indication lights under the Nos. of air conditioners that are operating.
- D. "System Down" is indicated when all air conditioners in the system are in non-operation.

HOW TO DISPLAY THE INDIVIDUALLY SCREEN

■ Displaying the INDIVIDUALLY screen

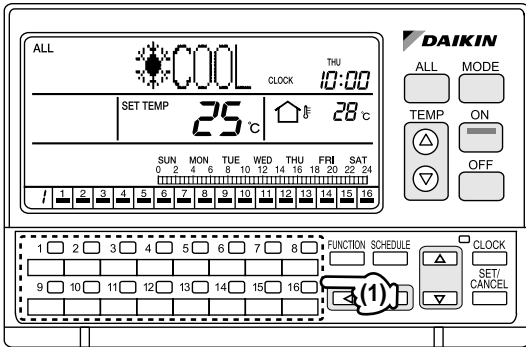

[Operating Procedure]

Press one of the individual group selection buttons (1) (1 - 16).

NOTE

Operate buttons only when the backlights are lit.

[Screen Display]

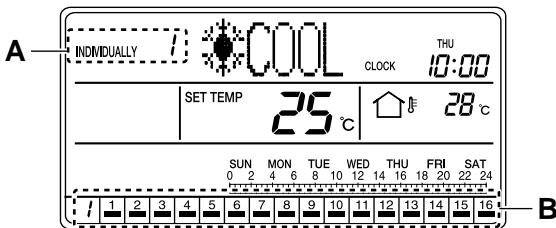

- A. The INDIVIDUALLY screen appears, and the No. of the selected air conditioner is indicated at the upper left corner of the screen.
(In the above screen, unit No. 1 is selected.)
- B. This section displays the Nos. of all connected air conditioners (groups).
The ■■■■ indication lights under the Nos. of air conditioners that are operating.

■ When an unconnected air conditioner (group) is selected

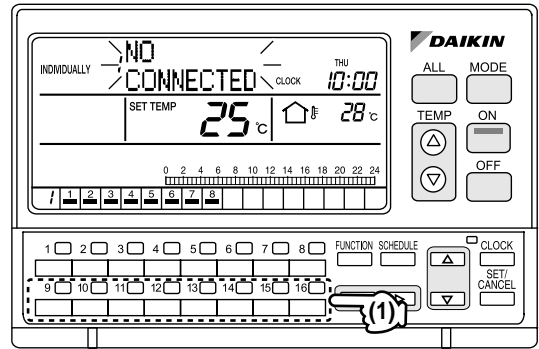

[Operating Procedure]

If the No. of an unconnected air conditioner is selected with one of the individual group selection buttons (1) (1 - 16), the operation mode display section (dot matrix) shows a blinking "NO CONNECTED" indication for 2 seconds.

After the indication blinks for 2 seconds, the display returns to the air conditioner screen that was displayed prior to the selection of the unconnected air conditioner (group).

* In the above diagram, unconnected air conditioners are unit Nos. 9 through 16.

[Screen Display]

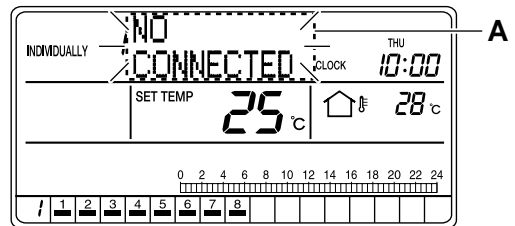

- A. If the No. of an unconnected air conditioner is selected with one of the individual group selection buttons (1 - 16), the operation mode display section (dot matrix) shows a blinking "NO CONNECTED" indication for 2 seconds.

HOW TO TURN ALL UNITS ON OR OFF SIMULTANEOUSLY

■ Turning on all connected units

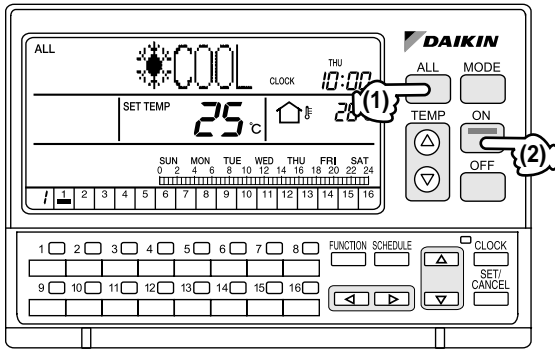

[Operating Procedure]

1. Press the ALL button (1) to display the ALL screen.
2. Press the ON button (2) to turn on all connected air conditioners (groups).

[Screen Display]

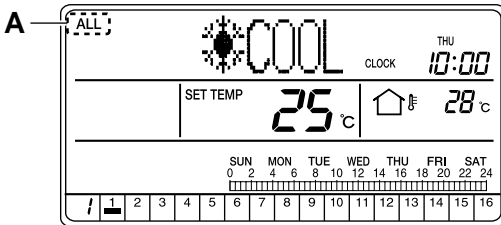

- A. When the ALL button (1) is pressed, the ALL screen appears and “ALL” is indicated at the upper left corner of the screen.
If no button is operated for 20 seconds, the display changes to the INDIVIDUALLY screen.

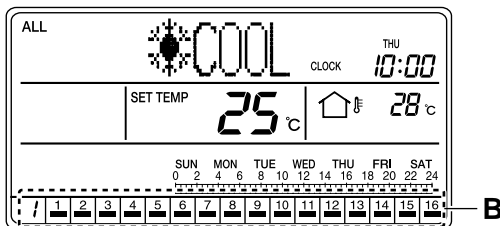

- B. When the ON button (2) is pressed, all connected air conditioners (groups) start operation.
The ■ indications appear in the operation monitor section.

■ Stopping all connected units

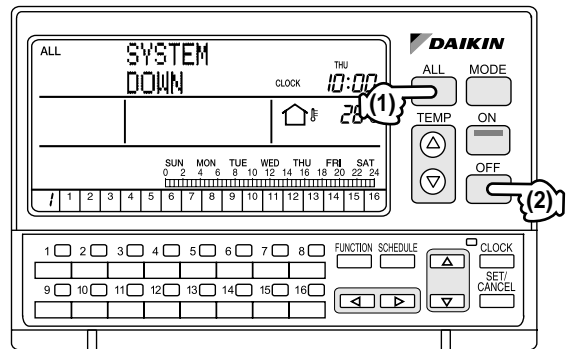

[Operating Procedure]

1. Press the ALL button (1) to display the ALL screen.
2. Press the OFF button (2) to stop all connected air conditioners (groups).

[Screen Display]

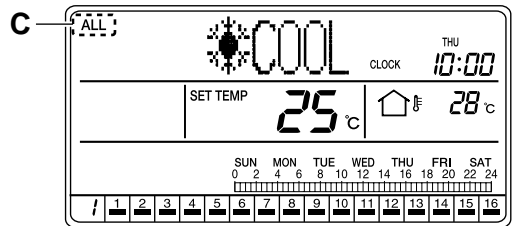

- C. When the ALL button (1) is pressed, the ALL screen appears and “ALL” is indicated at the upper left corner of the screen.

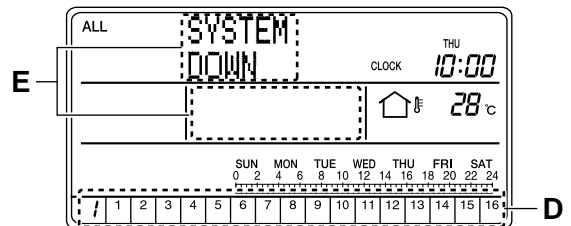

- D. Press the OFF button (2) to stop all connected air conditioners (groups).
The ■ indications in the operation monitor section disappear.
- E. “SYSTEM DOWN” is indicated in the operation mode display section (dot matrix), and the set temperature indication disappears.

HOW TO TURN UNITS ON OR OFF INDIVIDUALLY

■ Turning On specific connected air conditioners

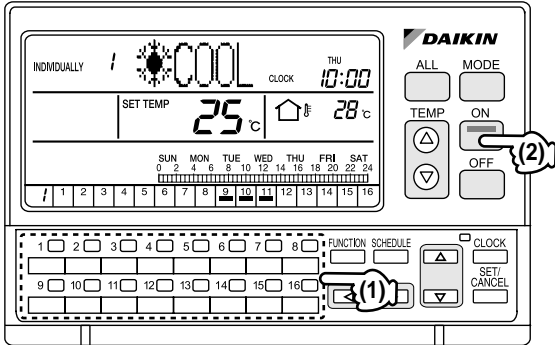

[Operating Procedure]

1. Select an air conditioner (group) using one of the individual group selection buttons (1) (1 - 16) to display the INDIVIDUALLY screen.
2. Press the ON button (2) to turn on the selected air conditioner (group).

[Screen Display]

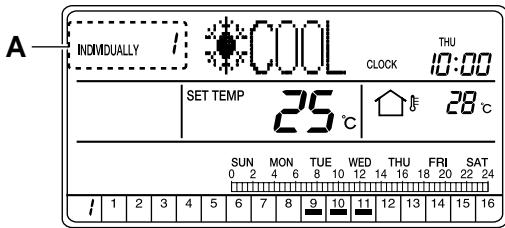

- A. When one of the individual group selection buttons (1) (1 - 16) is pressed, the INDIVIDUALLY screen appears and the selected air conditioner No. is shown at the upper left corner of the screen.

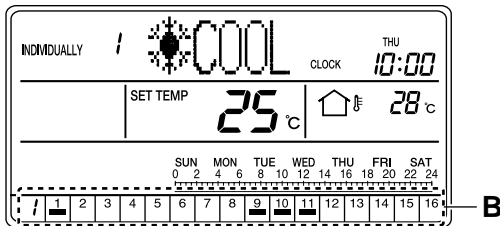

- B. Press the ON button (2) to turn on the selected air conditioner (group). The ■■■■ indication lights under the No. of the selected air conditioner.

■ Turning Off specific connected air conditioners

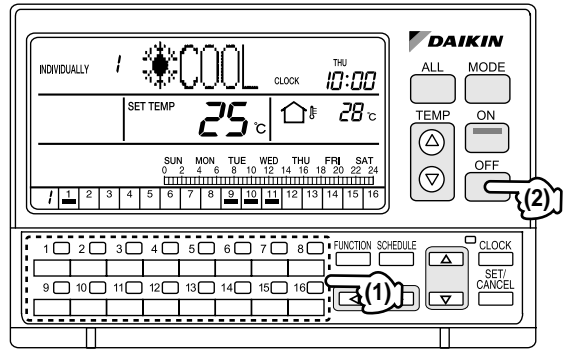

[Operating Procedure]

1. Select an air conditioner (group) using one of the individual group selection buttons (1) (1 - 16) to display the INDIVIDUALLY screen.
2. Press the OFF button (2) to turn off the selected air conditioner (group).

[Screen Display]

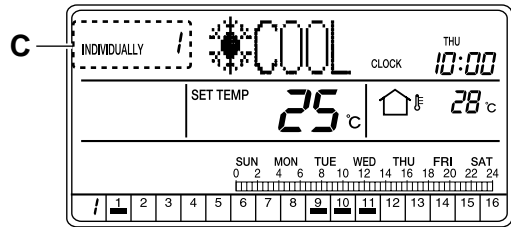

- C. When one of the individual group selection buttons (1) (1 - 16) is pressed, the INDIVIDUALLY screen appears and the selected air conditioner No. is shown at the upper left corner of the screen.

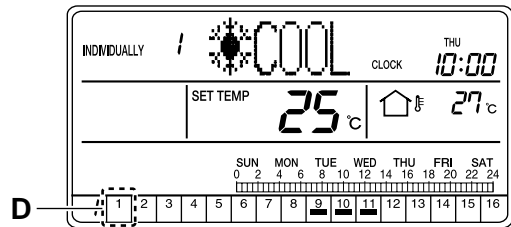

- D. Press the OFF button (2) to turn off the selected air conditioner (group). The ■■■■ indication under the selected air conditioner No. in the operation monitor section disappears.

HOW TO CHANGE THE OPERATION MODE

■ Changing the operation mode of all connected air conditioners

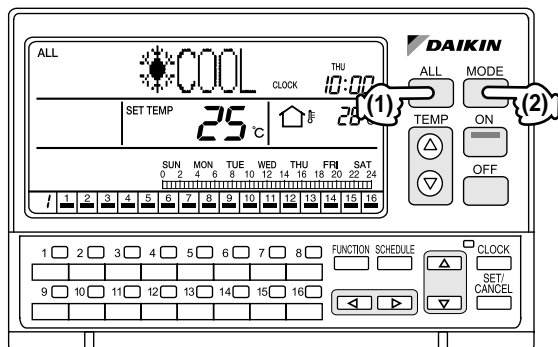

[Operating Procedure]

1. Press the ALL button (1) to display the ALL screen.
2. Each time the MODE button (2) is pressed, the operation mode changes in the following sequence.



[Screen Display]

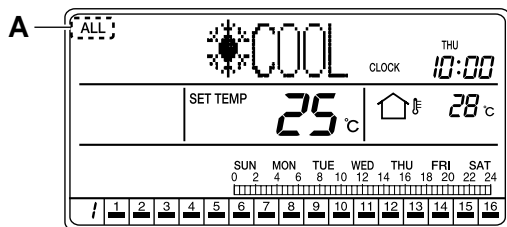

- A. When the ALL button (1) is pressed, the ALL screen appears and “ALL” is indicated at the upper left of the screen.
If no button is operated for 20 seconds, the display changes to the INDIVIDUALLY screen.

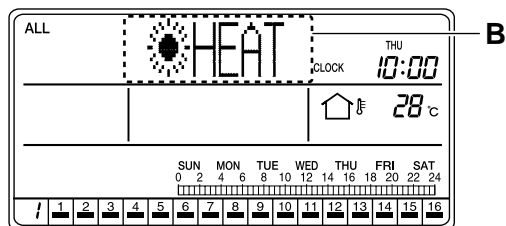

- B. Each time the MODE button (2) is pressed, the operation mode of all connected air conditioners (groups) changes in the following sequence.



■ Changing the operation mode of specific connected air conditioners

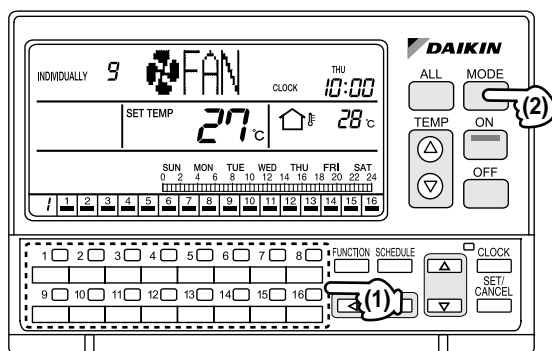

[Operating Procedure]

1. Select an air conditioner (group) using one of the individual group selection buttons (1) (1 - 16) to display the INDIVIDUALLY screen.
2. Each time the MODE button (2) is pressed, the operation mode changes in the following sequence.



NOTE

The operation mode cannot be changed to VENTILATION by selecting Total Heat Exchanger with one of the individual group selection buttons (1) (1 - 16) and by pressing the MODE button (2).
In this case, the “NO FUNCTION” indication blinks for 2 seconds in the operation mode display section (dot matrix).

[Screen Display]

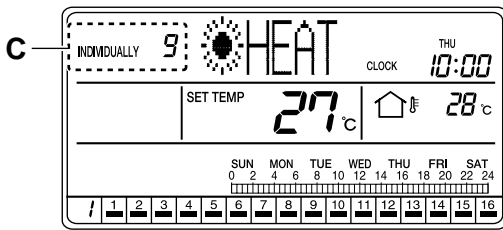

- C. When the No. of an air conditioner is selected with one of the individual group selection buttons (1) (1 - 16), the display changes to the INDIVIDUALLY screen and the No. of the selected air conditioner is shown at the upper left corner of the screen.

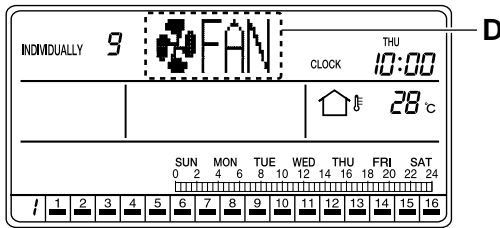

- D. Each time the MODE button (2) is pressed, the operation mode of the selected air conditioner (group) changes in the following sequence.



HOW TO ADJUST THE SET TEMPERATURE

- Adjusting the set temperature in all connected air conditioners

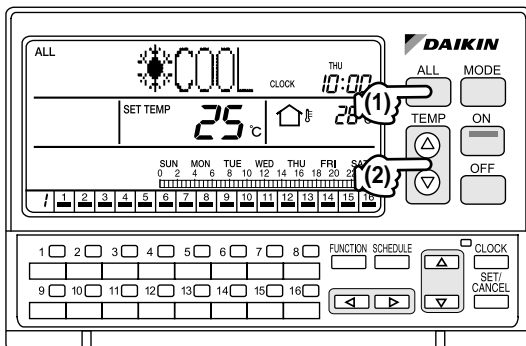

[Operating Procedure]

1. Press the ALL button (1) to display the ALL screen.
2. Each time one of the TEMP buttons (2) is pressed, the set temperature changes.
Press the Δ button to raise the set temperature by 1°C. Press the ∇ button to lower the set temperature by 1°C.

[Screen Display]

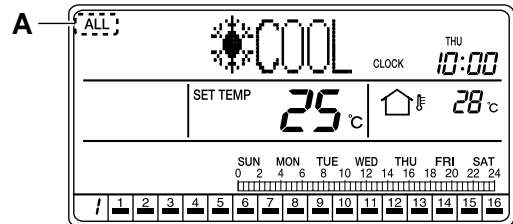

- A. When the ALL button (1) is pressed, the ALL screen appears and "ALL" is indicated at the upper left of the screen.

If no button is operated for 20 seconds, the display changes to the INDIVIDUALLY screen.

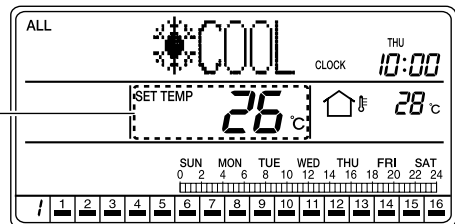

- B. Press the Δ TEMP button (2) to raise the set temperature by 1°C.

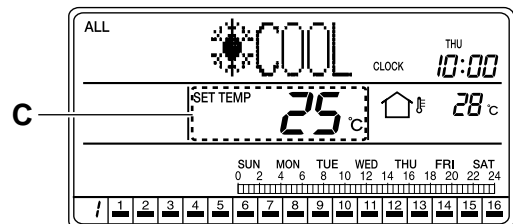

- C. Press the ∇ TEMP button (2) to lower the set temperature by 1°C.

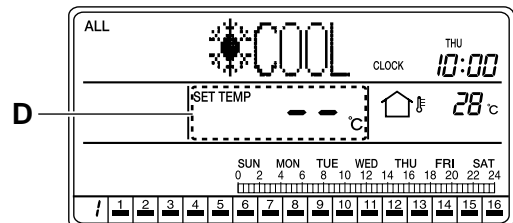

- D. If you do not want to set the temperature in all connected air conditioners (groups), set the set temperature to “-”.
- The “-” indication appears after pressing the Δ button to raise the set temperature to the highest temperature setting and pressing the Δ button one more time.
- The “-” indication also appears after pressing the ∇ button to set the lowest temperature setting and pressing the ∇ button one more time.

■ Adjusting the set temperature in specific connected air conditioners

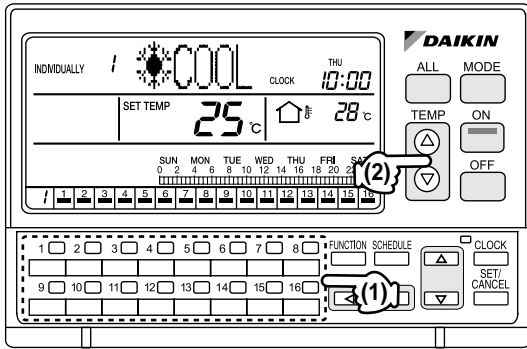

[Operating Procedure]

1. Select an air conditioner (group) to be set by using one of the individual group selection buttons (1) (1 - 16).
2. Each time one of the TEMP buttons (2) is pressed, the set temperature in the selected air conditioner (group) changes. Press the Δ button to raise the set temperature by 1°C. Press the ∇ button to lower the set temperature by 1°C.

[Screen Display]

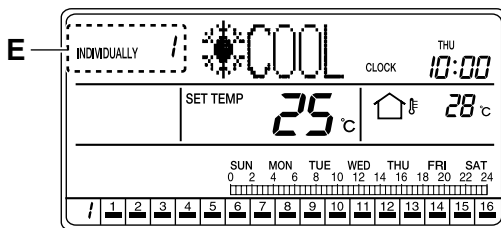

- E. This section displays the No. of the air conditioner selected with one of the individual group selection buttons (1) (1 - 16).

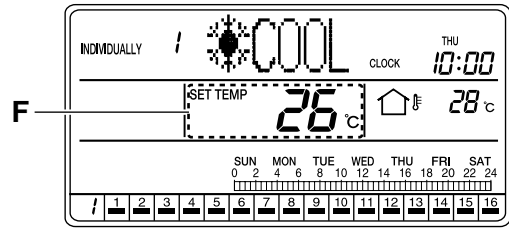

- F. Press the Δ TEMP button (2) to raise the set temperature in the selected air conditioner (group) by 1°C.

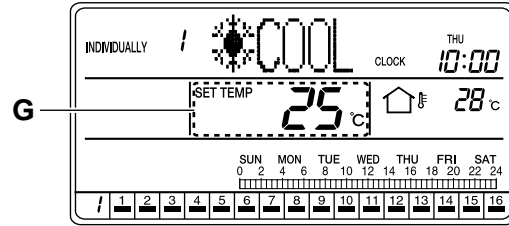

- G. Press the ∇ TEMP button (2) to lower the set temperature in the selected air conditioner (group) by 1°C.

OPERATION CODE

■ Setting Prohibit Remote Control, Central Control Priority, etc.

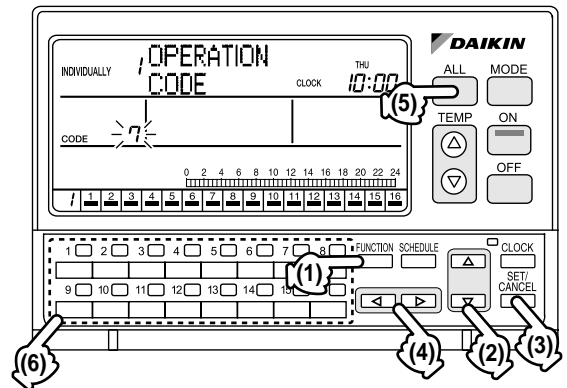

[Operating Procedure]

1. While the ALL or INDIVIDUALLY screen is displayed, press the FUNCTION button (1) once.
2. The Function Menu appears. The Function Menu changes as follows when the Δ or ∇ button (2) is pressed.

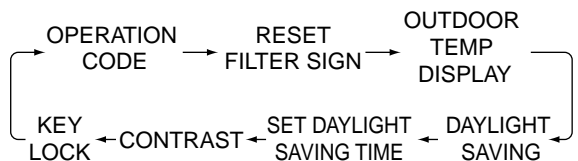

3. Select OPERATION CODE to display the operation code setting screen.
4. Using the ALL button (5) or one of the individual group selection buttons (6) (1 - 16), select the air conditioner (group) in which an operation code is to be set.
5. Press the ◀ or ▶ button (4) to set an operation code.
Press the ▶ button to increment the operation code. Press the ◀ button to decrement the operation code.
6. Press the SET/CANCEL button (3) once to complete the operation code setting procedure.
The operation code indication blinks for 3 seconds and changes to constant On. Then, the display returns to the ALL screen if the setting was made in the ALL screen, or to the INDIVIDUALLY screen if the setting was made in the INDIVIDUALLY screen.

* The operation code entered last takes precedence. Therefore, if the setting is made in the ALL screen after the setting is entered in the INDIVIDUALLY screen, the setting made in the ALL screen will be applied.

NOTE 🗨️

1. Operate buttons while the backlights are lit.
2. In steps 2 through 5, if no button is operated for 1 minute, the display returns to the ALL screen when the setting was made in the ALL screen, or to the INDIVIDUALLY screen if the setting was made in the INDIVIDUALLY screen.
In the above-mentioned case, the setting being entered will not be applied.

[Screen Display]

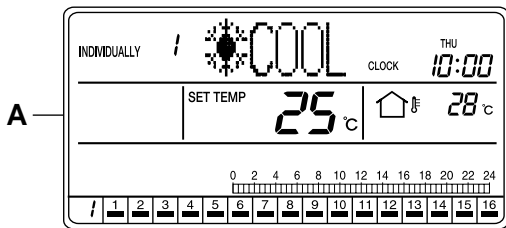

- A. While the ALL or INDIVIDUALLY screen is displayed, press the FUNCTION button (1) once.

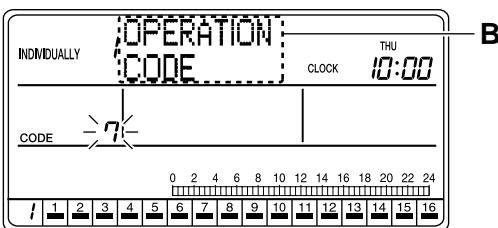

- B. The Function Menu appears. The Function Menu changes as follows when the Δ or ▽ button (2) is pressed.

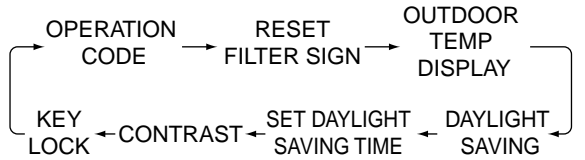

If no button is pressed for 2 seconds while the display shows screen B to screen E on page 13, a guidance message, "Δ ▽ BUTTONS: CHANGE FUNCTION, ◀ ▶ BUTTONS: CHANGE OPERATION CODE, SET/CANCEL BUTTON: SET," appears in the operation mode display section (dot matrix).

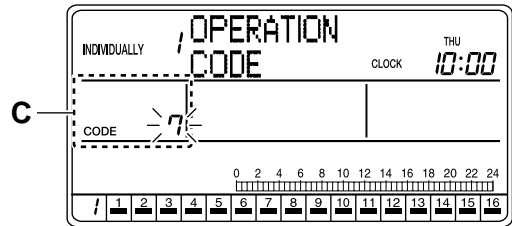

- C. Select OPERATION CODE to display the operation code setting screen.

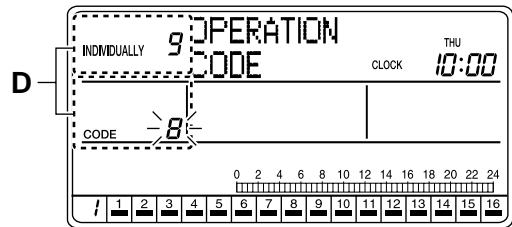

- D. Using the ALL button (5) or one of the individual group selection buttons (6) (1 - 16), select the air conditioner (group) in which an operation code is to be set.

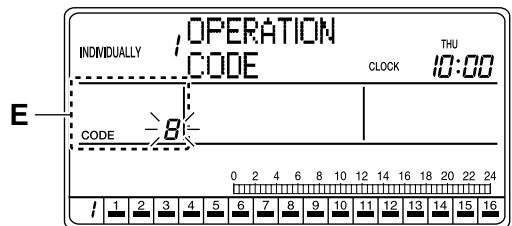

- E. Press the ◀ or ▶ button (4) to set an operation code.
Press the ▶ button to increment the operation code. Press the ◀ button to decrement the operation code.

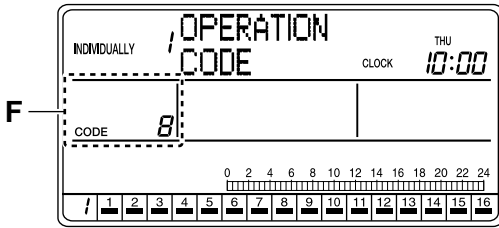

F. Press the SET/CANCEL button (3) once to complete the operation code setting procedure. The operation code indication blinks for 3 seconds and changes to constantly On. Then, the display returns to the ALL screen if the setting was made in the ALL screen, or to the INDIVIDUALLY screen if the setting was made in the INDIVIDUALLY screen.

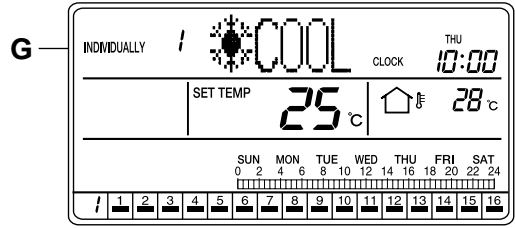

G. The operation code indication blinks for 3 seconds and changes to constantly On. Then, the display returns to the ALL screen if the setting was made in the ALL screen, or to the INDIVIDUALLY screen if the setting was made in the INDIVIDUALLY screen.

* Regarding the details of operation codes, refer to "Details of Operation Codes" on the following page.

[Details of Operation Codes]

Twenty modes, which are combinations of one of the following operation control modes and the remote ON/OFF, set temperature and operation mode that can be performed with a remote controller, can be set in operation codes 0 through 19. They can be also displayed on the screen.

- Prohibit Remote Controller..... To enable ON/OFF control only from the central remote controller. (Remote controllers cannot be used for ON/OFF control.)
- Permit Only OFF from Remote Controller..... To enable ON control only from the central remote controller and allows the use of remote controllers for OFF control only. (The central remote controller can be also used for OFF control.)
- Central Controller Priority..... To enable ON control only from the central remote controller and allows the use of remote controllers for ON/OFF control of units that were turned on by the central remote controller.
- Last Button Priority..... To enable ON/OFF control from both the central remote controller and remote controllers.
- Remote Controller Permit Timer..... To enable ON/OFF control from remote controllers during the SCHEDULE timer operation, and disallow the central remote controller to turn on units at the programmed ON time. (Use of remote controllers is permitted at the programmed ON time, and use of remote controllers is prohibited at the programmed OFF time. Air conditioners turn off at the programmed OFF time.)

How to select an operation code

- When using a remote controller, select either permit or prohibit for each of the ON/OFF, set temperature and operation mode settings, and set the operation code indicated in the rightmost column in the table below.

(Examples)

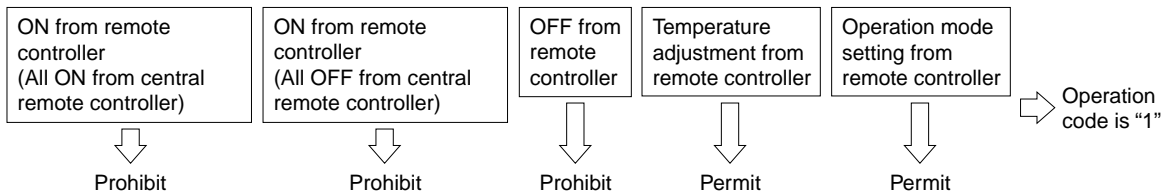

Control mode	Operation performed from remote controller					Operation Code
	ON		OFF	Temperature setting	Operation mode setting	
	All ON by central remote controller, individual ON, ON by timer	All OFF by central remote controller, individual OFF, OFF by timer				
Prohibit Remote Controller	Prohibit (Examples)	Prohibit (Examples)	Prohibit (Examples)	Prohibit (Examples)	Prohibit	0
Permit Only OFF from Remote Controller					Permit (Examples)	1 (Examples)
	Central Control Priority	Permit	Permit	Permit	Prohibit	2
Permit					3	
Last Button Priority	Permit	Permit	Permit	Prohibit	4	
				Permit	5	
Remote Controller Permit Timer	Permit (When timer ON)	Prohibit (When timer OFF)	Permit	Prohibit	6	
				Permit	7	
					Prohibit	8
					Permit	9
					Prohibit	10
					Permit	11
					Prohibit	12
					Permit	13
					Prohibit	14
					Permit	15
					Prohibit	16
					Permit	17

Remote Controller Permit Timer	Permit (When timer ON)	Prohibit (When timer OFF)	Permit	Prohibit	8
				Permit	18
				Permit	9
				Prohibit	19

NOTE) When remote controllers are not used, do not select "Remote Controller Permit Timer."
Selecting this setting disallows the use of the timer for air conditioner operation.

RESET FILTER SIGN

■ Turning off the Filter sign

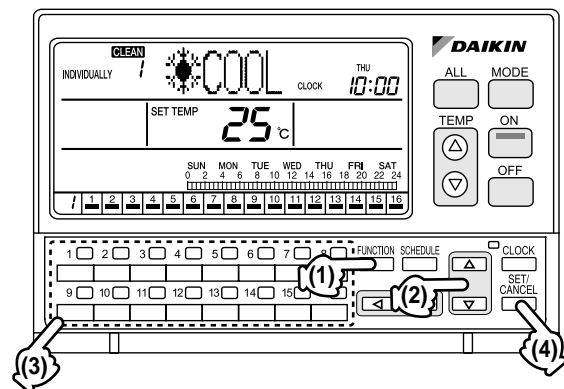

[CLEAN Signs]

When the filter or element needs cleaning, the Filter or Element sign appears on the multi-language central remote controller.

(* For details, refer to "CLEAN SIGN" on page 5.)

After cleaning the filter, reset the Filter sign by using RESET FILTER SIGN in the Function Menu.

[Operating Procedure]

1. While the ALL or INDIVIDUALLY screen is displayed, press the FUNCTION button (1) once.
2. The Function Menu appears.
The Function Menu changes as follows when the Δ or ∇ button (2) is pressed.

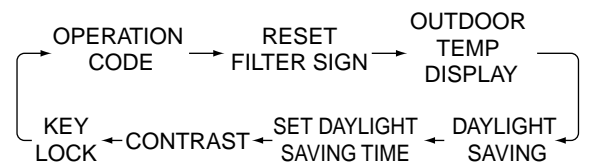

3. In the Reset Filter Sign screen, select the air conditioner for which the filter sign is to be reset by using one of the individual group selection buttons (3).
4. Press the SET/CANCEL button (4) to reset the Filter sign.

* When the SET/CANCEL button is held pressed for more than 4 seconds, the Filter sign will be reset in all units.

- If no button is operated for 1 minute or the FUNCTION button (1) is pressed, the display returns to the ALL screen when the setting was made in the ALL screen, or to the INDIVIDUALLY screen when the setting was made in the INDIVIDUALLY screen.

NOTE

- In each of steps 2 through 4, if no button is operated for 1 minute, the display returns to the ALL screen when the setting was made in the ALL screen, or to the INDIVIDUALLY screen when the setting was made in the INDIVIDUALLY screen.
In the above-mentioned case, the setting being entered will not be applied.

[Screen Display]

* The Element sign is displayed as shown below.

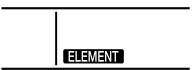
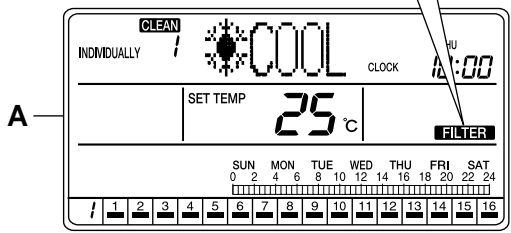
- To reset the Filter sign, press the FUNCTION button (1) once while the ALL or INDIVIDUALLY screen is displayed.

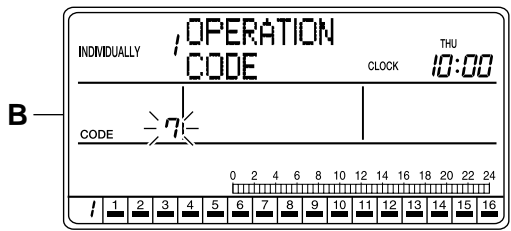

- The Function Menu appears.
If no button is pressed for 2 seconds, a guidance message, "△ ▽ BUTTONS: CHANGE OPERATION CODE, < > BUTTONS: CHANGE OPERATION CODE, SET/CANCEL BUTTON: SET," appears in the operation mode display section (dot matrix).

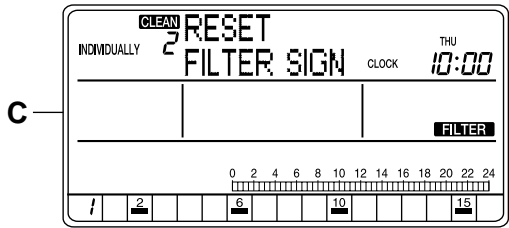

- Each time the △ or ▽ button (2) is pressed, the Function Menu changes in the following sequence:

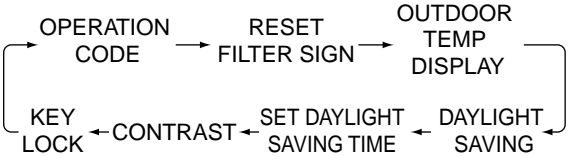

Display the Reset Filter Sign screen.

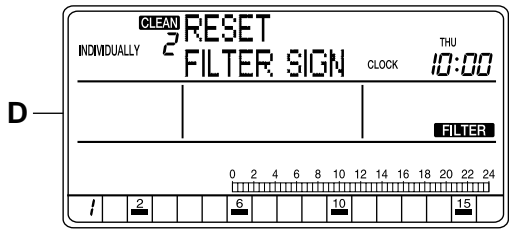

- The Reset Filter Sign screen indicates the air conditioner for which the Filter or Element sign has turned on.
If no button is pressed for 2 seconds while the display shows screen C on page 16 to screen H on page 17, a guidance message, "△ ▽ BUTTONS: CHANGE FUNCTION, 1 - 16 BUTTONS: SELECT INDIVIDUAL GROUP, SET/CANCEL BUTTON: RESET," appears.

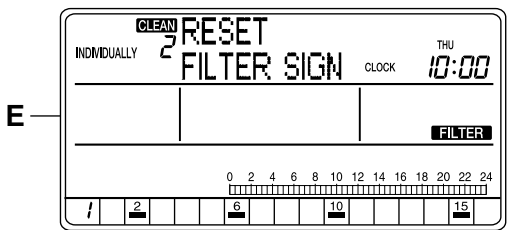

- Using an individual group selection button, select the air conditioner to be reset, and press the SET/CANCEL button.
The Filter sign in the selected air conditioner will be reset.

OUTDOOR TEMPERATURE DISPLAY

■ Displaying the temperature of the outdoor unit connected to the selected air conditioner

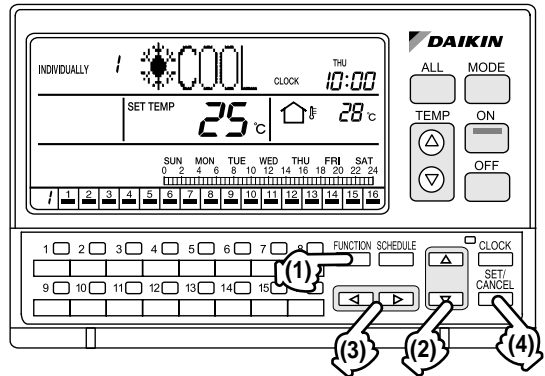

[Operating Procedure]

1. While the ALL or INDIVIDUALLY screen is displayed, press the FUNCTION button (1) once.
2. The Function Menu appears. The Function Menu changes as follows when the Δ or ∇ button (2) is pressed.

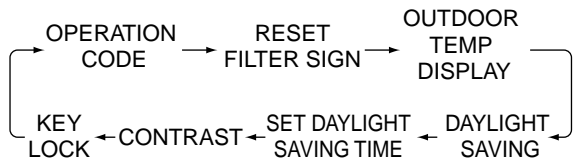

3. In the Outdoor Temp Display setting screen, press the \triangleleft or \triangleright button (3) to display or hide the temperature indication.

* The Outdoor Temp Display is turned Off by default.

4. Press the SET/CANCEL button (4) to complete the Outdoor Temp Display setting procedure.
5. If no button is operated for 1 minute or the FUNCTION button (1) is pressed, the display returns to the ALL screen when the setting was made in the ALL screen, or to the INDIVIDUALLY screen when the setting was made in the INDIVIDUALLY screen.

NOTE

1. In each of steps 2 through 4, if no button is operated for 1 minute, the display returns to the ALL screen when the setting was made in the ALL screen, or to the INDIVIDUALLY screen when the setting was made in the INDIVIDUALLY screen. In the above-mentioned case, the setting being entered will not be applied.

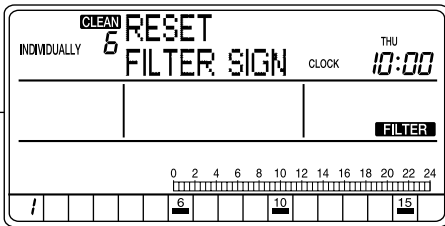

- F. The Filter sign in the selected air conditioner has been reset.

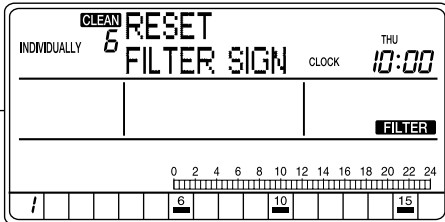

- G. To reset the Filter sign in all units, hold the SET/CANCEL button pressed for more than 4 seconds.

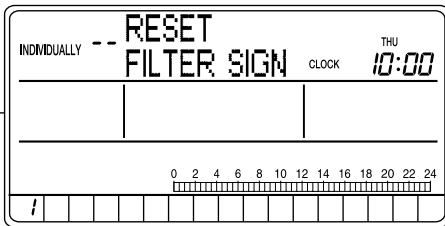

- H. The Filter sign has been reset in all units. If no button is operated for 1 minute or the FUNCTION button (1) is pressed, the display returns to the INDIVIDUALLY screen.

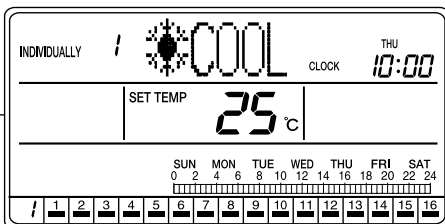

- I. The display shows the INDIVIDUALLY screen. The Filter sign has been reset.

[Screen Display]

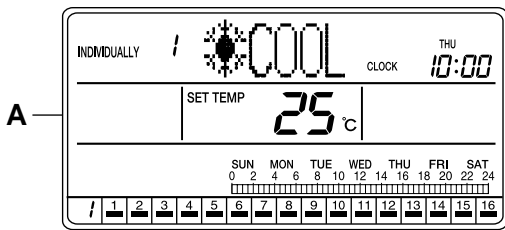

A. To set the Outdoor Temp Display, press the FUNCTION button (1) once while the ALL or INDIVIDUALLY screen is displayed.

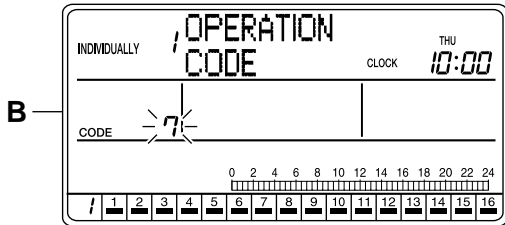

B. The Function Menu appears. If no button is pressed for 2 seconds, a guidance message, “△ ▽ BUTTONS: CHANGE FUNCTION, ◀ ▶ BUTTONS: CHANGE OPERATION CODE, SET/CANCEL BUTTON: SET,” appears in the operation mode display section (dot matrix).

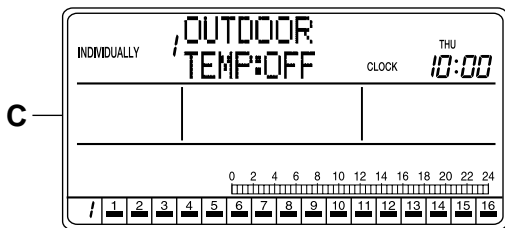

C. Each time the △ or ▽ button (2) is pressed, the Function Menu changes in the following sequence:

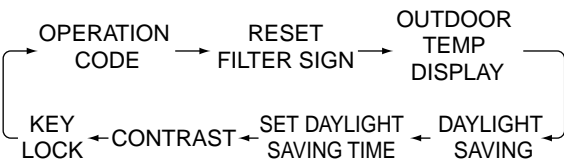

Display the Outdoor Temp Display setting screen.

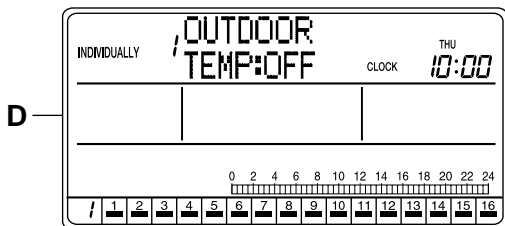

D. The Outdoor Temp Display setting screen appears.

If no button is pressed for 2 seconds while the display shows screen C to screen E on page 18, a guidance message, “△ ▽ BUTTONS: CHANGE FUNCTION, ◀ ▶ BUTTONS: DISPLAY ON/OFF, SET/CANCEL BUTTON: SET,” appears.

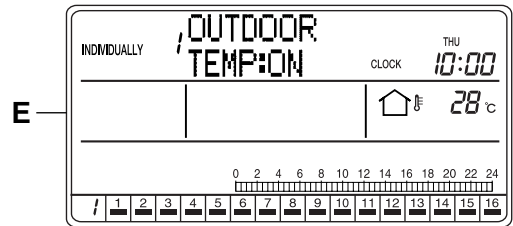

E. Using the ◀ or ▶ button, display or hide the Outdoor Temp Display. This completes the Outdoor Temp Display setting procedure.

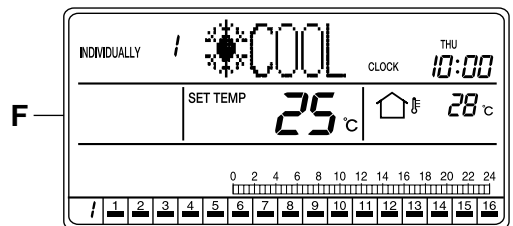

F. If no button is operated for 1 minute or the FUNCTION button (1) is pressed once, the display returns to the INDIVIDUALLY screen. If the Outdoor Temp Display has been set to ON, the outdoor temperature will be displayed.

* The outdoor temperature display time is 1 minute.

DAYLIGHT SAVING

■ Automatic advancement of the current time for daylight saving period

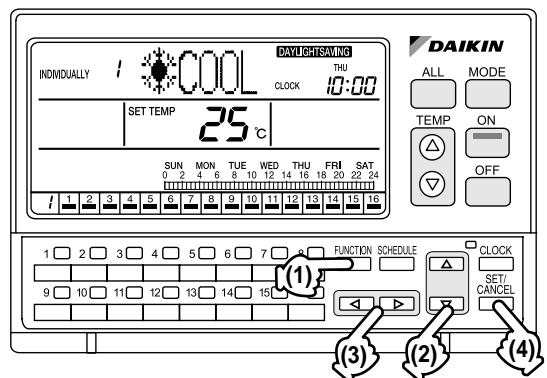

[Operating Procedure]

1. While the ALL or INDIVIDUALLY screen is displayed, press the FUNCTION button (1) once.
2. The Function Menu appears. The Function Menu changes as follows when the Δ or ∇ button (2) is pressed.

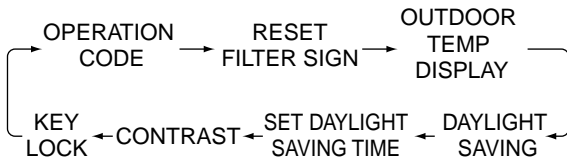

3. In the Daylight Saving setting screen, enable or disable the Daylight Saving function by using the \triangleleft or \triangleright button (3).
 - * The Daylight Saving function is enabled by default.
4. Press the SET/CANCEL button (4) to complete the Daylight Saving setting procedure.
5. If no button is operated for 1 minute or the FUNCTION button (1) is pressed, the display returns to the ALL screen when the setting was made in the ALL screen, or to the INDIVIDUALLY screen when the setting was made in the INDIVIDUALLY screen.

NOTE

1. In each of steps 2 through 4, if no button is operated for 1 minute, the display returns to the ALL screen when the setting was made in the ALL screen, or to the INDIVIDUALLY screen when the setting was made in the INDIVIDUALLY screen. In the above-mentioned case, the setting being entered will not be applied.

[Screen Display]

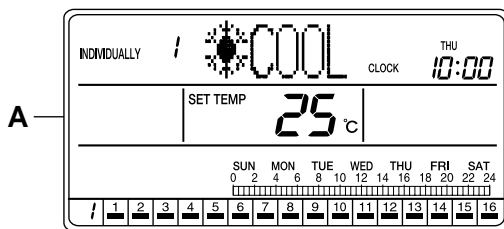

- A. To set the Daylight Saving function, press the FUNCTION button (1) once while the ALL or INDIVIDUALLY screen is displayed.

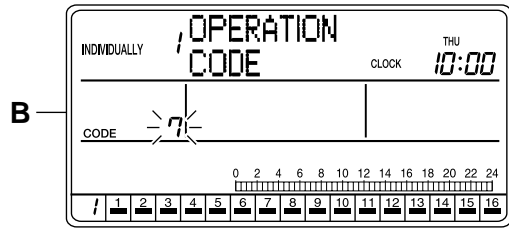

- B. The Function Menu appears. If no button is pressed for 2 seconds, a guidance message, “ Δ ∇ BUTTONS: CHANGE FUNCTION, \triangleleft \triangleright BUTTONS: CHANGE OPERATION CODE, SET/CANCEL BUTTON: SET,” appears in the operation mode display section (dot matrix).

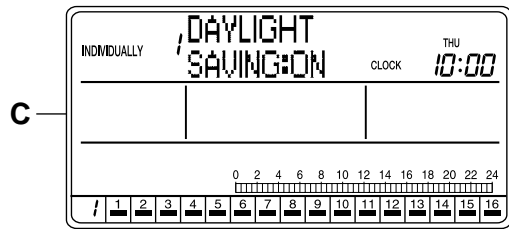

- C. Each time the Δ or ∇ button (2) is pressed, the Function Menu changes in the following sequence:

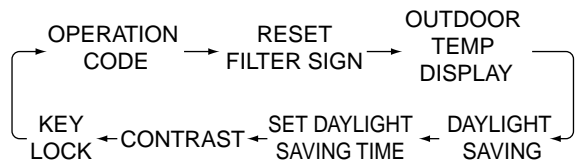

Display the Daylight Saving setting screen.

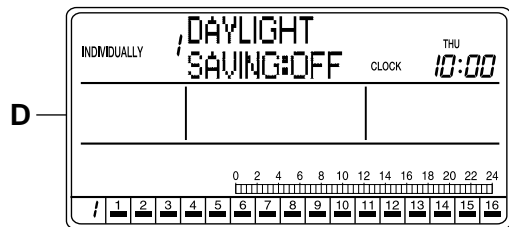

- D. The Daylight Saving setting screen appears. If no button is pressed for 2 seconds while the display shows screen C on page 19 to screen E on page 20, a guidance message, “ Δ ∇ BUTTONS: CHANGE FUNCTION, \triangleleft \triangleright BUTTONS: DISPLAY ON/OFF, SET/CANCEL BUTTON: SET,” appears.

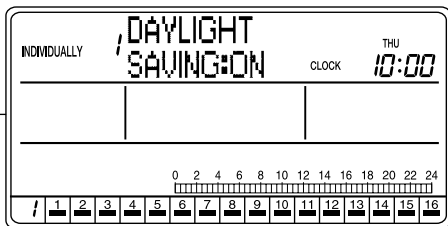

E

- E. Using the ◀ or ▶ button, enable or disable the Daylight Saving function.
This completes the Daylight Saving setting procedure.

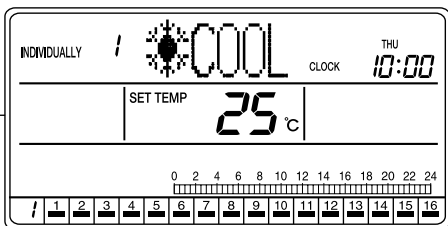

F

- F. If no button is operated for 1 minute or the FUNCTION button (1) is pressed once, the display returns to the INDIVIDUALLY screen.

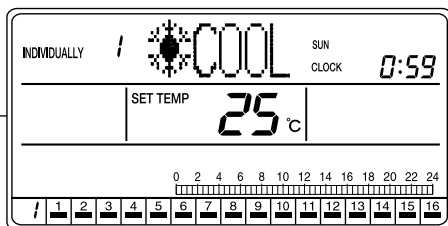

G

- G. If the Daylight Saving function is enabled, the clock automatically advances 1 hour when the daylight saving period starts.

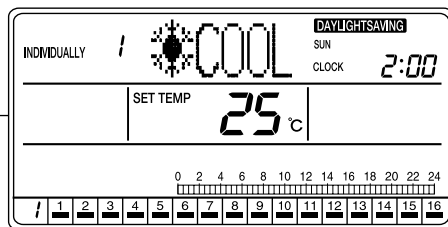

H

- H. The daylight saving time is displayed. During the daylight saving period, the "DAYLIGHT SAVING" indication is displayed on the screen.

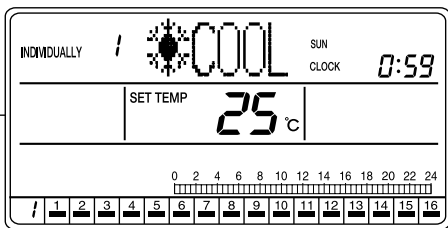

I

- When the daylight saving period ends, the clock moves back 1 hour, and the "DAYLIGHT SAVING" indication disappears.

HOW TO SET A DAYLIGHT SAVING PERIOD

■ Setting the start day and end day of daylight saving period

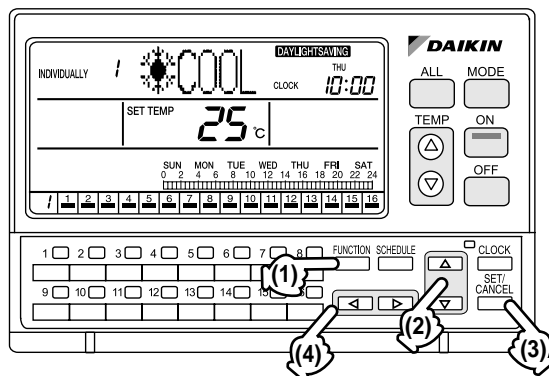

[Operating Procedure]

- While the ALL or INDIVIDUALLY screen is displayed, press the FUNCTION button (1) once.
- The Function Menu appears. The Function Menu changes as follows when the Δ or ∇ button (2) is pressed.

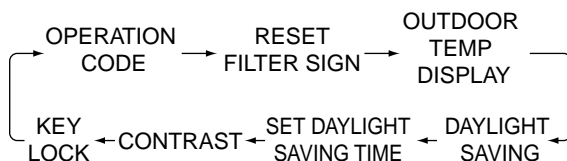

- Press the SET/CANCEL button (3) in the Daylight Saving setting screen. The display changes to the menu screen for setting the daylight saving period.

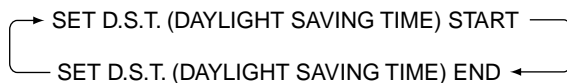

- Press the Δ or ∇ button (2) to select SET D.S.T. (DAYLIGHT SAVING TIME) START or SET D.S.T. (DAYLIGHT SAVING TIME) END. Press the SET/CANCEL button (3) to display the input setting screen for the selected setting item for daylight saving period.

- Press the Δ or ∇ button (2) to select the input setting for the selected start/end day of daylight saving period.

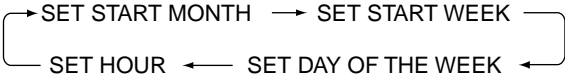

- Using the \triangleleft or \triangleright button (4), enter the daylight saving period. Press the SET/CANCEL button (3) to end the setting procedure.

* [Default start day setting]
 Month: March, week: final week, day of the week: Sunday, hour: 1:00

* [Default end day setting]
 Month: October, week: final week, day of the week: Sunday, hour: 1:00

- If no button is operated for 1 minute or if the FUNCTION button (1) is pressed, the display returns to the ALL screen when the settings were made in the ALL screen, or to the INDIVIDUALLY screen when the settings were made in the INDIVIDUALLY screen.

NOTE

- In each of steps 2 through 6, if no button is operated for 1 minute, the display returns to the ALL screen when the setting was made in the ALL screen, or to the INDIVIDUALLY screen when the setting was made in the INDIVIDUALLY screen. In the above-mentioned case, the setting being entered will not be applied.

[Screen Display: SET D.S.T. (DAYLIGHT SAVING TIME) START]

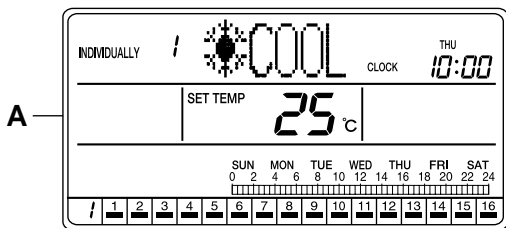

- To set the daylight saving period, press the FUNCTION button (1) once while the ALL screen or INDIVIDUALLY screen is displayed.

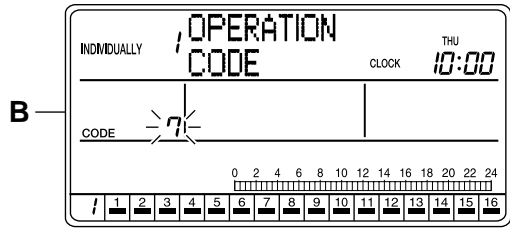

- The Function Menu appears. If no button is operated for 2 seconds, a guidance message, " Δ ∇ BUTTONS: CHANGE FUNCTION, \triangleleft \triangleright BUTTONS: CHANGE OPERATION CODE, SET/CANCEL BUTTON: SET," appears in the operation mode display section (dot matrix).

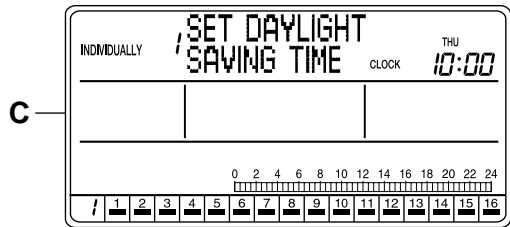

- The Function Menu changes as follows when the Δ or ∇ button (2) is pressed.

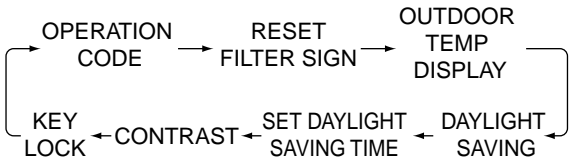

Display the Daylight Saving setting screen.

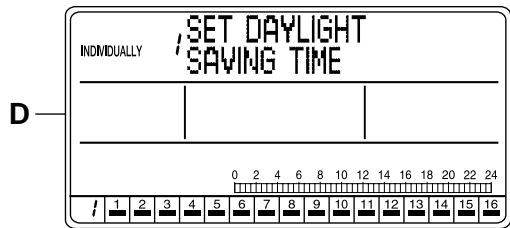

- The Daylight Saving setting screen appears. If no button is operated for 2 seconds in screen D, a guidance message, " Δ ∇ BUTTONS: CHANGE FUNCTION, SET/CANCEL BUTTON: SET D.S.T PERIOD," appears.

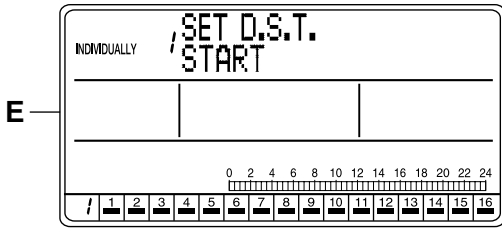

E. Press the SET/CANCEL button (3) to display the menu screen for setting the daylight saving period. Press the Δ or ∇ button (2) to select the start day of the daylight saving period.

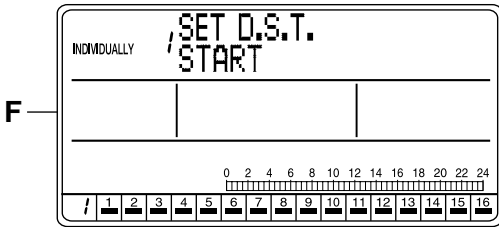

F. If no button is operated for 2 seconds in screen F, a guidance message, “ Δ ∇ BUTTONS: START/END, SET/CANCEL BUTTON: SET,” appears. Press the SET/CANCEL button (3) to display the input setting screen for setting the start day of the daylight saving period.

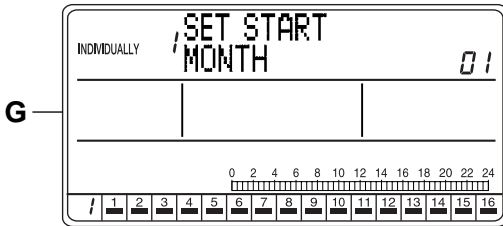

G. The input setting screen for setting the daylight saving period appears. If no button is operated for 2 seconds while the display shows screen G on page 22 to screen S on page 23, a guidance message, “ Δ ∇ BUTTONS: SET M/W/D AND TIME, \triangleleft \triangleright BUTTONS: SET D.S.T., SET/CANCEL BUTTON: SET,” appears.

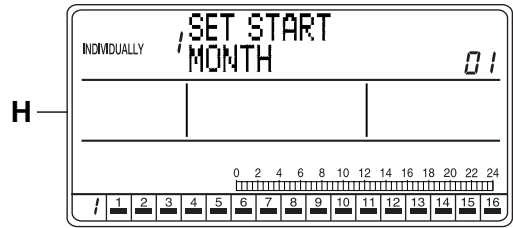

H. Press the Δ or ∇ button (2) to select the input setting for the start day of the daylight saving period.

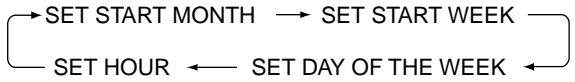

Select the input setting for the month of the daylight saving start day.

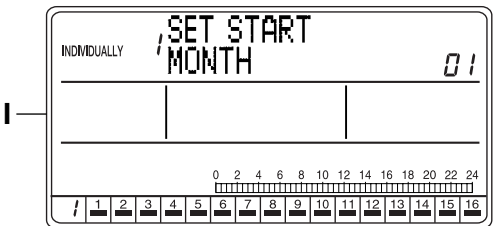

I. Using the \triangleleft or \triangleright button (4), set the month of the daylight saving start day. Pressing the \triangleright button advances the month indication. Pressing the \triangleleft button reverses the indication.

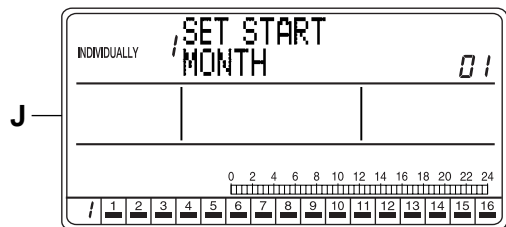

J. Press the Δ or ∇ button (2) to select the input setting for the week of the daylight saving start day.

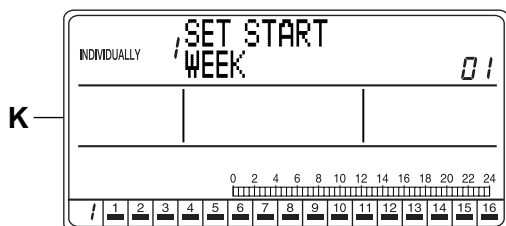

K. The display changes to the input setting screen for the week of the daylight saving start day.

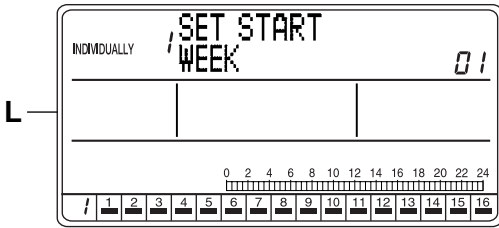

L. Using the ◀ or ▶ button (4), set the week of the daylight saving start day. Pressing the ▶ button advances the week indication. Pressing the ◀ button reverses the indication.

* 01 - 04: 1st week to 4th week, 05: final week of the set month

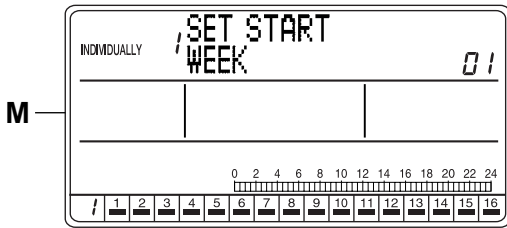

M. Press the ▲ or ▼ button (2) to select the input setting for the day of the week of the daylight saving start day.

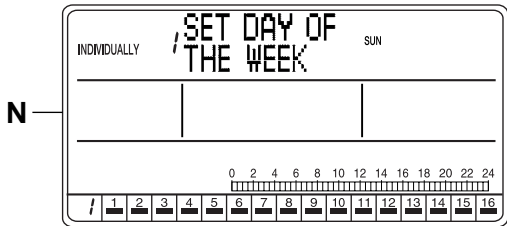

N. The display changes to the input setting screen for the day of the week of the daylight saving start day.

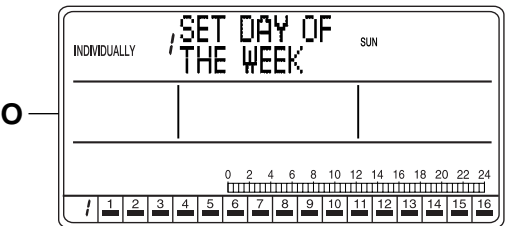

O. Using the ◀ or ▶ button (4), set the day of the week of the daylight saving start day. Pressing the ▶ button advances the day of the week indication. Pressing the ◀ button reverses the indication.

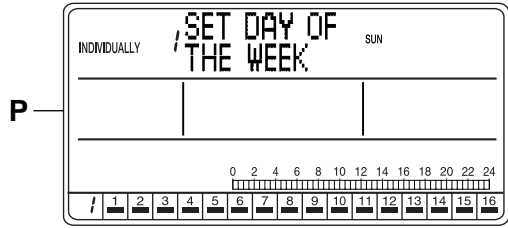

P. Press the ▲ or ▼ button (2) to select the input setting for the daylight saving start time.

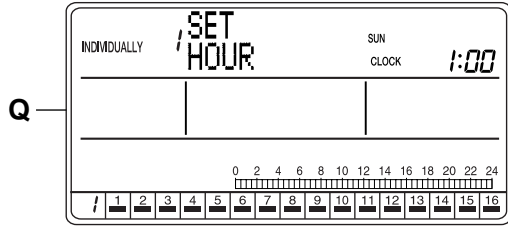

Q. The display changes to the input setting screen for the daylight saving start time.

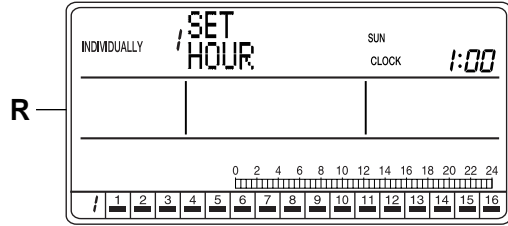

R. Using the ◀ or ▶ button (4), set the daylight saving start time.

Pressing the ▶ button advances the time indication. Pressing the ◀ button reverses the indication.

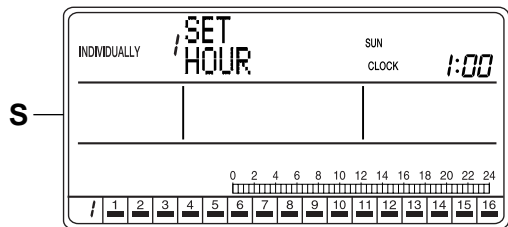

S. Press the SET/CANCEL button (3) to end the setting.

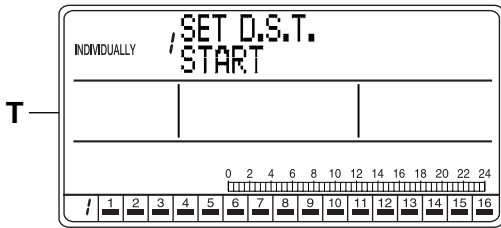

- T.** The display returns to the setting screen for the daylight saving period.
To continue setting the end day of the daylight saving period, see E on page 24.

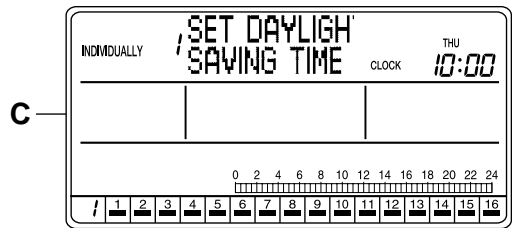

- C.** The Function Menu changes as follows when the Δ or ∇ button (2) is pressed.

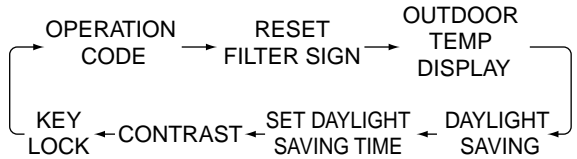

Display the Daylight Saving setting screen.

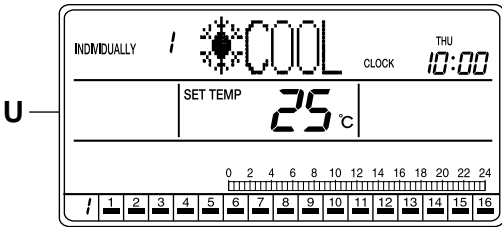

- U.** If no button is operated for 1 minute or if the FUNCTION button (1) is pressed once, the display returns to the INDIVIDUALLY screen.

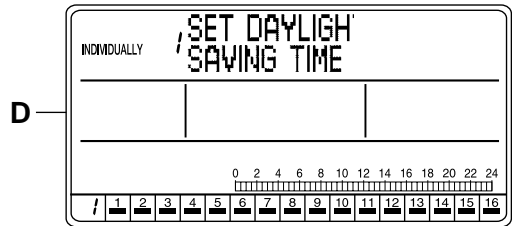

- D.** The Daylight Saving setting screen appears.
If no button is operated for 2 seconds in screen D, a guidance message, “ Δ ∇ BUTTONS: CHANGE FUNCTION, SET/CANCEL BUTTON: SET D.S.T PERIOD,” appears.

[Screen Display: SET D.S.T. (DAYLIGHT SAVING TIME) END]

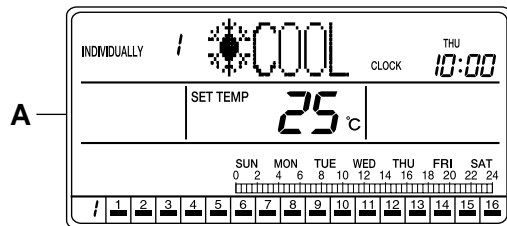

- A.** To set the daylight saving period, press the FUNCTION button (1) once while the ALL screen or INDIVIDUALLY screen is displayed.

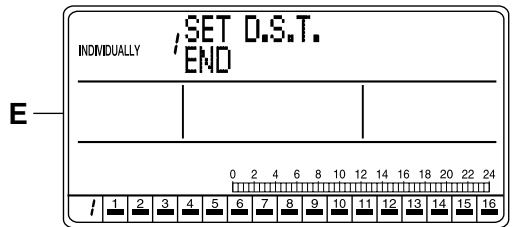

- E.** Press the SET/CANCEL button (3) to display the menu screen for setting the daylight saving period. Press the Δ or ∇ button (2) to select the end day of the daylight saving period.

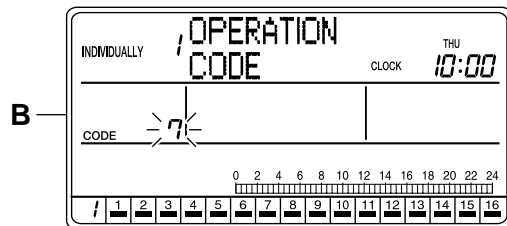

- B.** The Function Menu appears.
If no button is operated for 2 seconds, a guidance message, “ Δ ∇ BUTTONS: CHANGE FUNCTION, \triangleleft \triangleright BUTTONS: CHANGE OPERATION CODE, SET/CANCEL BUTTON: SET,” appears in the operation mode display section (dot matrix).

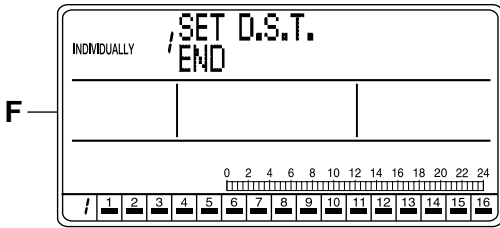

F. If no button is operated for 2 seconds in screen F, a guidance message, “△ ▽ BUTTONS: START/END, SET/CANCEL BUTTON: SET,” appears. Press the SET/CANCEL button (3) to display the input setting screen for setting the end day of the daylight saving period.

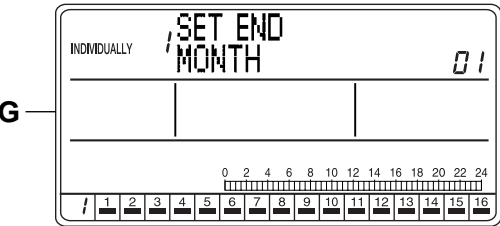

G. The input setting screen for setting the daylight saving period appears. If no button is operated for 2 seconds while the display shows screen G on page 25 to screen S on page 26, a guidance message, “△ ▽ BUTTONS: SET M/W/D AND TIME, < > BUTTONS: SET D.S.T., SET/CANCEL BUTTON: SET,” appears.

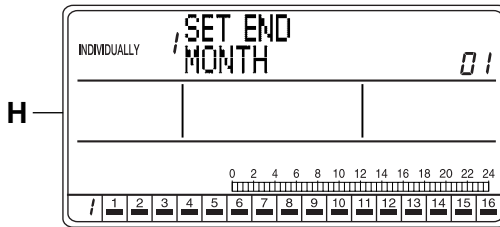

H. Press the △ or ▽ button (2) to select the input setting for the end day of the daylight saving period.

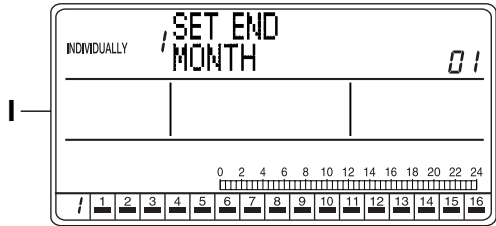
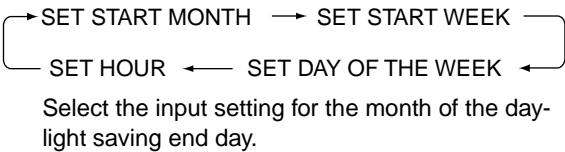

I. Using the < or > button (4), select the month of the daylight saving end day. Pressing the > button advances the month indication. Pressing the < button reverses the indication.

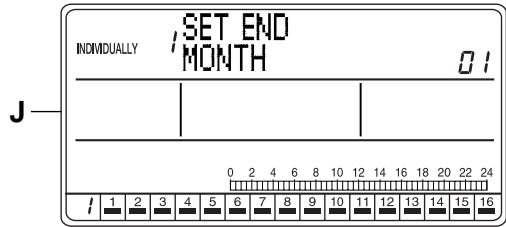

J. Press the △ or ▽ button (2) to select the input setting for the week of the daylight saving end day.

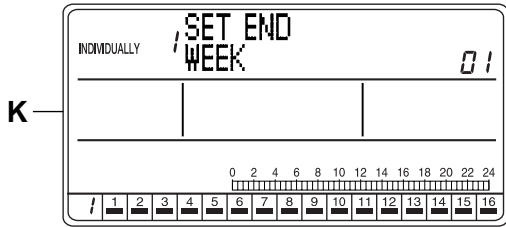

K. The display changes to the input setting screen for the week of the daylight saving end day.

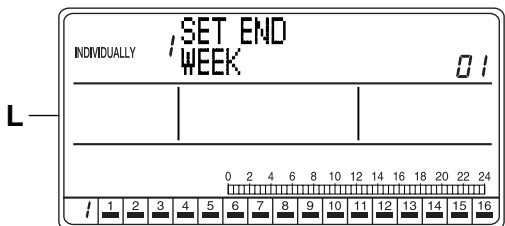

L. Using the < or > button (4), set the week of the daylight saving end day. Pressing the > button advances the week indication. Pressing the < button reverses the indication.

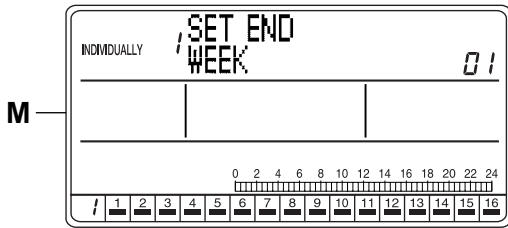

M. Press the Δ or ∇ button (2) to select the input setting for the day of the week of the daylight saving end day.

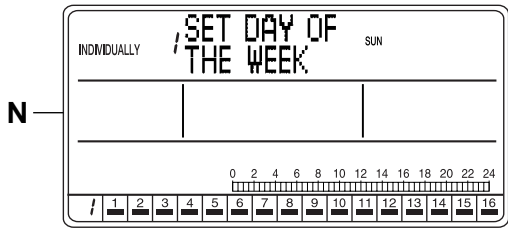

N. The display changes to the input setting screen for the day of the week of the daylight saving end day.

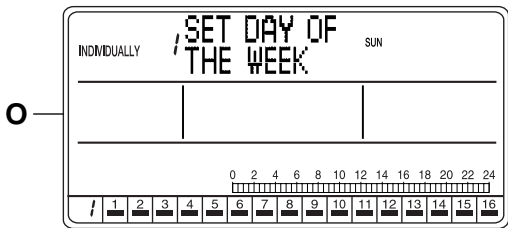

O. Using the \triangleleft or \triangleright button (4), set the day of the week of the daylight saving end day. Pressing the \triangleright button advances the day of the week indication. Pressing the \triangleleft button reverses the indication.

* 01 - 04: 1st week to 4th week, 05: final week of the set month

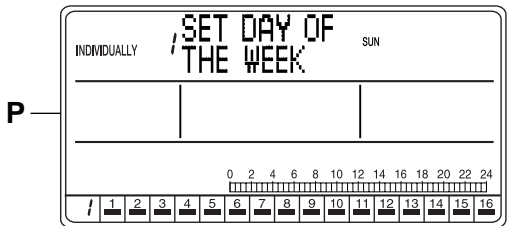

P. Press the Δ or ∇ button (2) to select the input setting for the daylight saving end time.

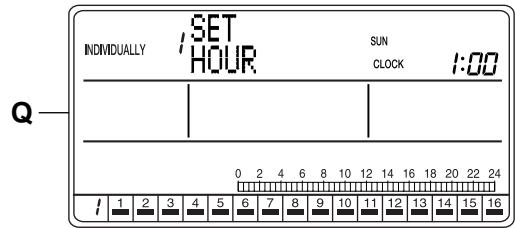

Q. The display changes to the input setting screen for the daylight saving end time.

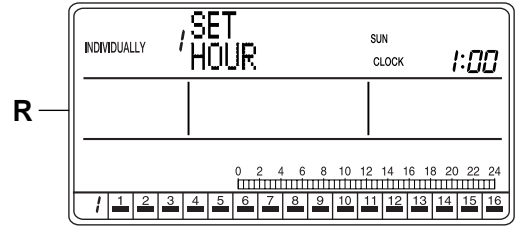

R. Using the \triangleleft or \triangleright button (4), set the daylight saving end time. Pressing the \triangleright button advances the time indication. Pressing the \triangleleft button reverses the indication.

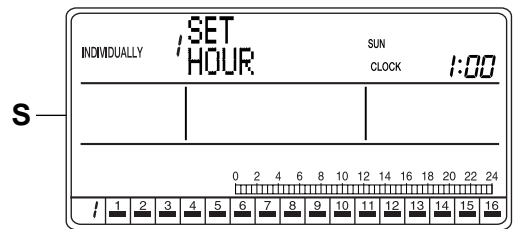

S. Press the SET/CANCEL button (3) to end the setting.

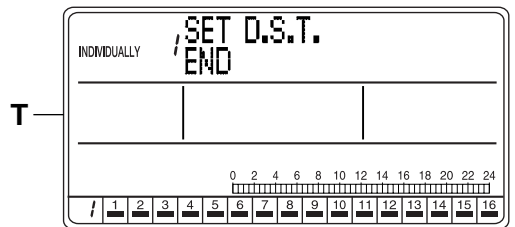

T. The display returns to the setting screen for the daylight saving period.

NOTE 🗨️

1. In each of steps 2 through 4, if no button is operated for 1 minute, the display returns to the ALL screen when the adjustment was made in the ALL screen, or to the INDIVIDUALLY screen when the adjustment was made in the INDIVIDUALLY screen.

[Screen Display]

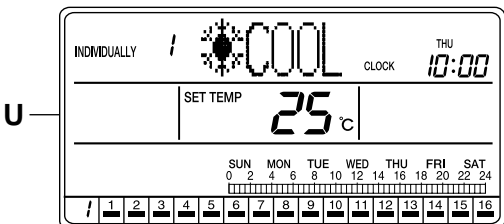

- U.** If no button is operated for 1 minute or if the FUNCTION button (1) is pressed once, the display returns to the INDIVIDUALLY screen.

CONTRAST SETTING

■ Adjusting the contrast of the LCD

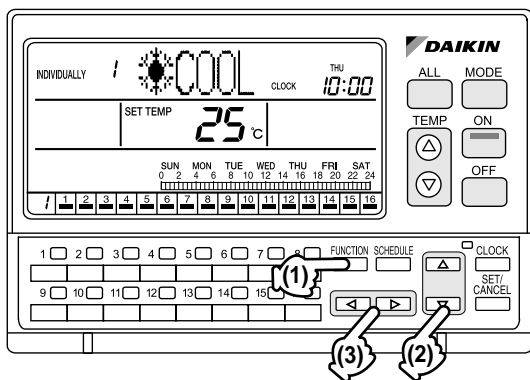

[Operating Procedure]

1. While the ALL or INDIVIDUALLY screen is displayed, press the FUNCTION button (1) once.
2. The Function Menu appears. The Function Menu changes as follows when the Δ or ∇ button (2) is pressed.

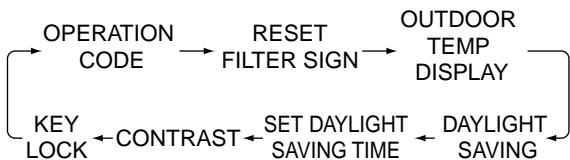

3. On the Contrast setting screen, adjust the contrast level by using the < or > button (3).

* The contrast level is set to "3" by default.

4. If no button is operated for 1 minute or the FUNCTION button (1) is pressed, the display returns to the ALL screen when the setting was made in the ALL screen, or to the INDIVIDUALLY screen when the setting was made in the INDIVIDUALLY screen.

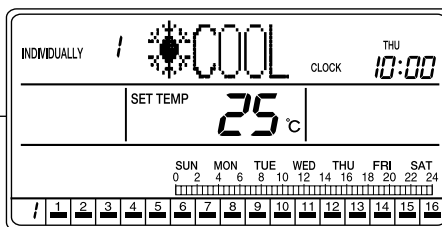

- A.** To adjust the contrast, press the FUNCTION button (1) once while the ALL or INDIVIDUALLY screen is displayed.

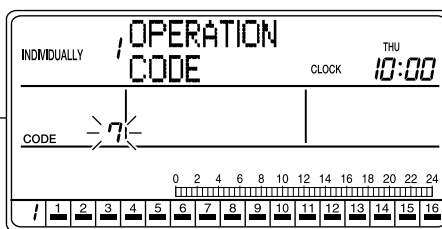

- B.** The Function Menu appears. If no button is pressed for 2 seconds, a guidance message, "Δ ∇ BUTTONS: CHANGE FUNCTION, < > BUTTONS: CHANGE OPERATION CODE, SET/CANCEL BUTTON: SET" appears in the operation mode display section (dot matrix).

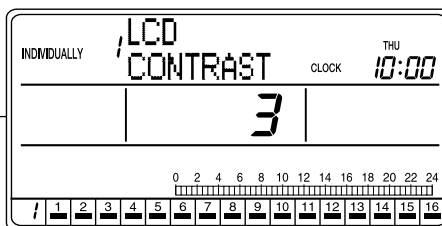

- C.** Each time the Δ or ∇ button (2) is pressed, the Function Menu changes in the following sequence:

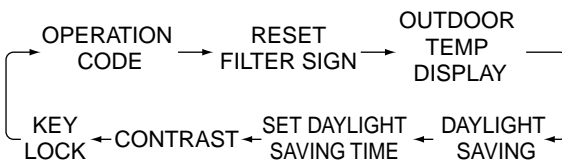

Display the Contrast setting screen.

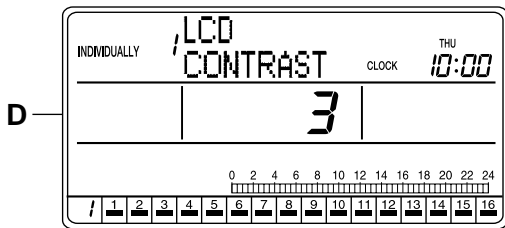

D. The Contrast setting screen appears and indicates the current contrast level.

If no button is operated for 2 seconds while the display shows screen C to screen E on page 27, a guidance message, “△ ▽ BUTTONS: CHANGE FUNCTION, ◀ ▶ BUTTONS: ADJUST CONTRAST,” appears.

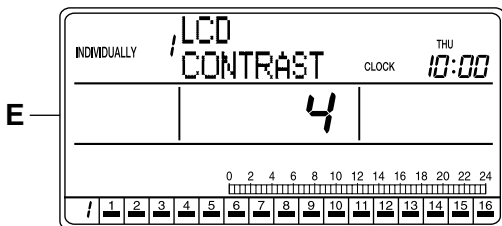

E. Press the ◀ or ▶ button to adjust the contrast level.

The contrast can be adjusted between 1 and 4.

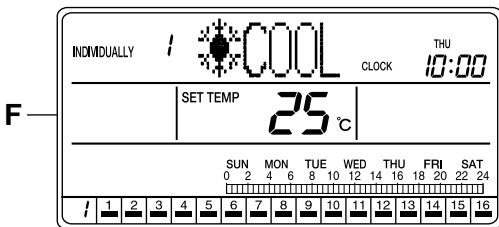

F. If no button is operated for 1 minute or the FUNCTION button (1) is pressed once, the display returns to the INDIVIDUALLY screen.

KEY LOCK SETTING

■ Disabling operation buttons

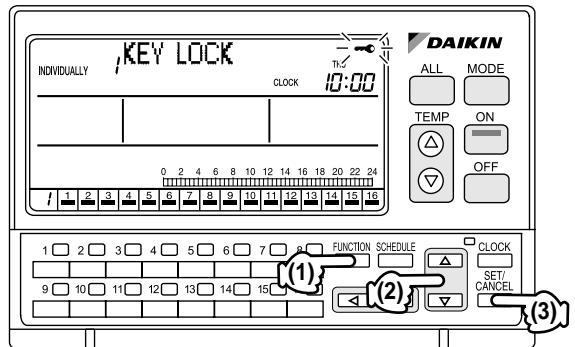

[Operating Procedure]

1. While the ALL or INDIVIDUALLY screen is displayed, press the FUNCTION button (1) once.
2. The Function Menu appears.
The Function Menu changes as follows when the △ or ▽ button (2) is pressed.

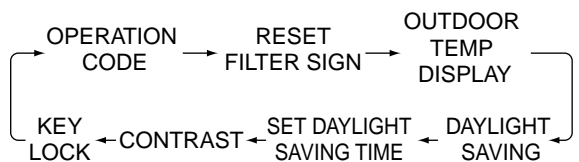

3. While the Key Lock screen is displayed, press the SET/CANCEL button (3) once.
The mark blinks for 2 seconds and changes to constant On. The key lock is set, and the display returns to the ALL screen if the setting was made in the ALL screen, or to the INDIVIDUALLY screen if the setting was made in the INDIVIDUALLY screen.
After the key lock is set, button operations for ON, OFF, operation mode change, etc. are disabled. If an operation for ON, OFF or operation mode change is performed, the “KEY LOCK” indication blinks for 4 seconds.
4. To cancel the key lock, hold the SET/CANCEL button (3) for more than 4 seconds.
The mark blinks for 1 second and then turns Off, indicating that the key lock has been cancelled.

NOTE

1. Operate buttons while the backlights are lit.
2. In each of steps 2 and 3, if no button is operated for 1 minute, the display returns to the ALL screen when the setting was made in the ALL screen, or to the INDIVIDUALLY screen when the setting was made in the INDIVIDUALLY screen.
In the above-mentioned case, the setting being entered will not be applied.

[Screen Display]

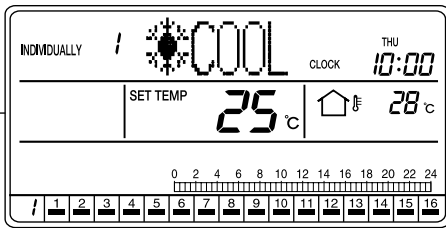

- A. While the ALL or INDIVIDUALLY screen is displayed, press the FUNCTION button (1) once.

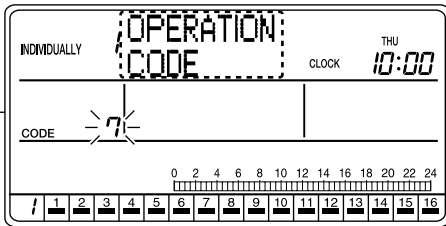

- B. The Function Menu appears.
If no button is operated for 2 seconds while the display shows screen B or C on page 29, a guidance message, "△ ▽ BUTTONS: CHANGE FUNCTION, ◀ ▶ BUTTONS: CHANGE OPERATION CODE, SET/CANCEL BUTTON: SET," appears in the operation mode display section (dot matrix).

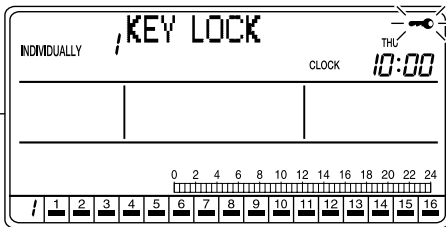

- C. Each time the △ or ▽ button (2) is pressed, the Function Menu changes in the following sequence:

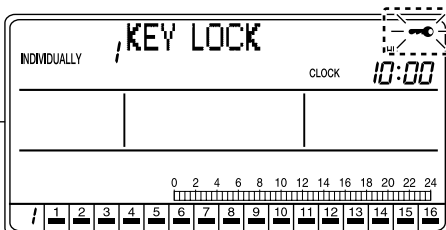
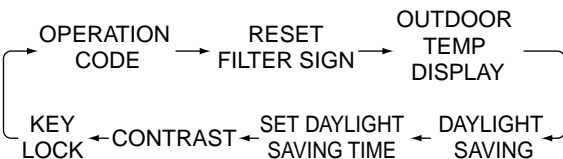

- D. While the KEY LOCK Menu screen is displayed, press the SET/CANCEL button (3) once.

- D. While the Key Lock Menu screen is displayed, press the SET/CANCEL button (3) once.
The  mark blinks for 2 seconds and changes to constant On. The key lock is set, and the display returns to the ALL screen if the setting was made in the ALL screen, or to the INDIVIDUALLY screen if the setting was made in the INDIVIDUALLY screen.

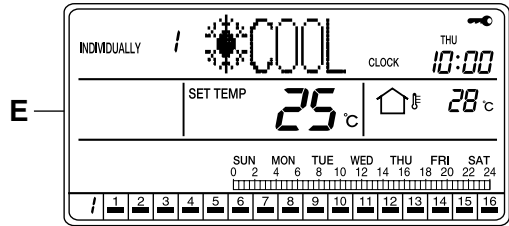

- E. The key lock is set and the display returns to the ALL screen if the setting was made in the ALL screen, or to the INDIVIDUALLY screen if the setting was made in the INDIVIDUALLY screen.

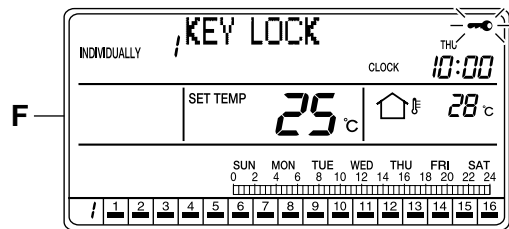

- F. When the key lock is enabled, button operations for ON, OFF, operation mode change, etc. cannot be performed.
If an operation for ON, OFF or operation mode change is performed, the "KEY LOCK" indication blinks for 4 seconds.

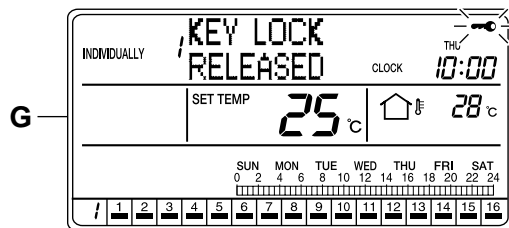

- G. To cancel the key lock, hold the SET/CANCEL button (3) pressed for more than 4 seconds.
The  mark blinks for 1 second and then turns Off, indicating that the key lock has been cancelled.

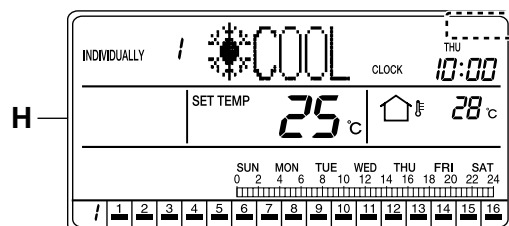

- H. While the ALL or INDIVIDUALLY screen is displayed, press the FUNCTION button (1) once.

- H. The key lock is cancelled, and the display returns to the ALL screen if the key lock was cancelled in the ALL screen, or to the INDIVIDUALLY screen if the key lock was cancelled in the INDIVIDUALLY screen.

SCHEDULE SETTING

■ Programming ON time and OFF time for each day of the week

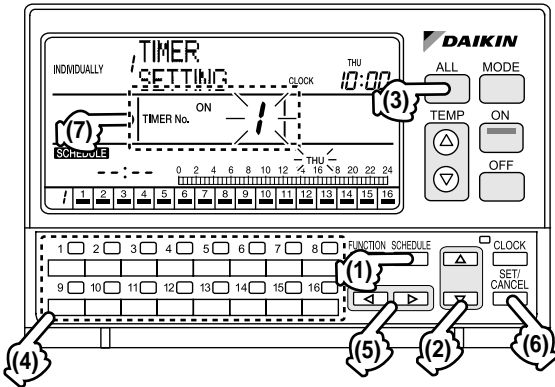

[Operating Procedure]

1. While the ALL or INDIVIDUALLY screen is displayed, press the SCHEDULE button (1) once.
2. The Schedule setting screen appears.
3. Using the ALL button (3) or one of the individual group selection buttons (4) (1 - 16), select the air conditioner (group) to be set.
4. Using the Δ or ∇ button (2), select a Timer No. (7). To set ON time, select TIMER ON. To set OFF time, select TIMER OFF. Up to 4 timer settings can be entered.

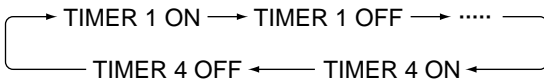

5. Press the \triangleleft or \triangleright button (5) to set the day of the week.
6. Press the SET/CANCEL button (6) once to apply the settings.
7. Using the Δ or ∇ button (2), select "SCHEDULE SETTING". The display changes to the Time setting screen. Press the \triangleleft or \triangleright button (5) to set time.
8. Press the SET/CANCEL button (6) once to apply the time setting. (All timers will be set.)

9. If no button is operated for 1 minute or the SCHEDULE button (1) is pressed, the display returns to the ALL screen when the setting was made in the ALL screen, or to the INDIVIDUALLY screen when the setting was made in the INDIVIDUALLY screen.

NOTE

1. Operate buttons while the backlights are lit.
2. In each of steps 2 through 7, if no button is operated for 1 minute, the display returns to the ALL screen when the setting was made in the ALL screen, or to the INDIVIDUALLY screen when the setting was made in the INDIVIDUALLY screen. In the above-mentioned case, the setting being entered will not be applied.
3. In step 4 (Timer No. (7) and "day of the week" setting screen) and step 7 (Time setting screen), pressing the SET/CANCEL button (6) moves the screen forward for the next setting step.

[Screen Display: Timer ON Setting]

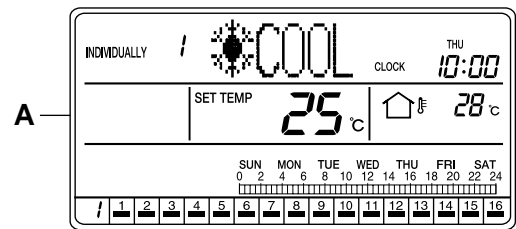

- A. While the ALL or INDIVIDUALLY screen is displayed, press the SCHEDULE button (1) once.

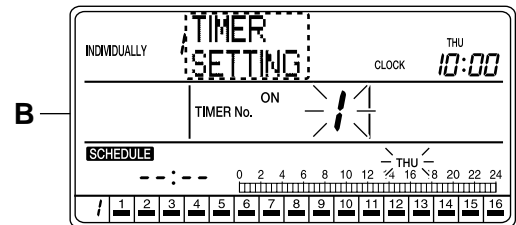

- B. The Schedule setting screen appears. If no button is operated for 2 seconds while the display shows screen B to screen F on page 30, a guidance message, " Δ ∇ BUTTONS: SELECT TIMER No., \triangleleft \triangleright BUTTONS: SELECT DAY OF THE WEEK, SET/CANCEL BUTTON: SET," appears and scrolls in the operation mode display section (dot matrix).

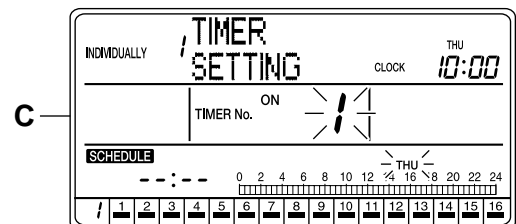

- C. Using the ALL button (3) or one of the individual group selection buttons (4) (1 - 16), select the air conditioner (group) to be set.

* If the timer is set in the ALL screen, the setting will apply to all air conditioners (groups).

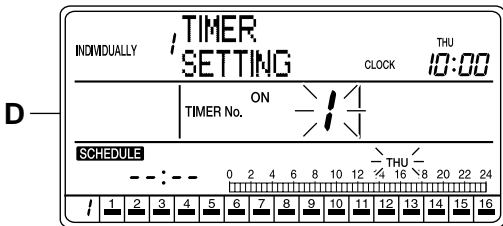

- D. Using the Δ or ∇ button (2), select TIMER ON and a Timer No. (7).

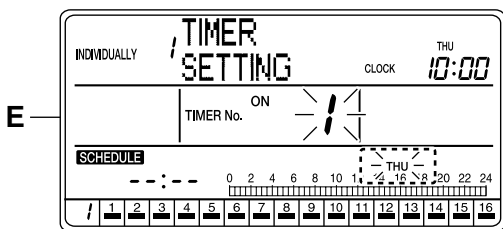
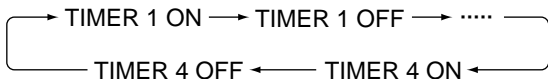

- E. Using the \triangleleft or \triangleright button (5), select the day of the week to set.

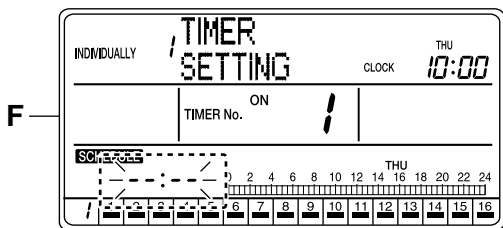
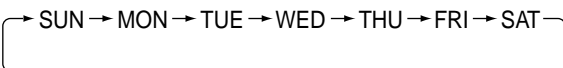

- F. Press the SET/CANCEL button (6) once to apply the setting.
The Timer No. (7) and "day of the week" indications change from blinking to constant On, and the set time indication blinks.

When the SET/CANCEL button (6) is pressed once again, the display returns to screen B (blinking Timer No. (7) and "day of the week" indications) shown on page 30.

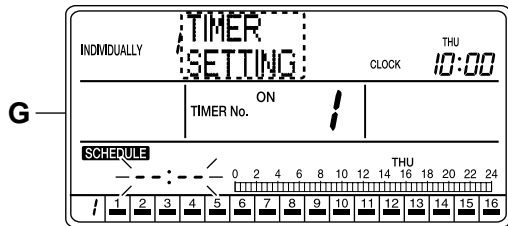

- G. If no button is operated for 2 seconds while the display shows screen G or screen H on page 31, a guidance message, " $\Delta \nabla$ BUTTONS: CHANGE FUNCTION, $\triangleleft \triangleright$ BUTTONS: SET TIME, SET/CANCEL BUTTON: SET," appears and scrolls in the operation mode display section (dot matrix).

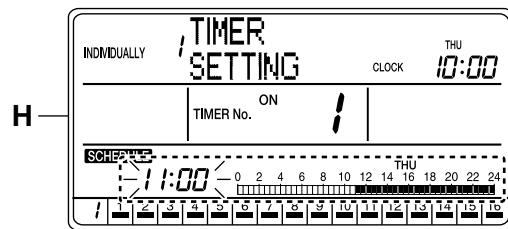

- H. Using the Δ or ∇ button (2), select "SCHEDULE SETTING". (This procedure is not necessary since "SCHEDULE SETTING" was selected in the first step.)

Press the \triangleleft or \triangleright button (5) to set time.
The blinking set time indication and the schedule bar graph shows the time setting.

* When the button is held pressed, the displayed time changes faster.

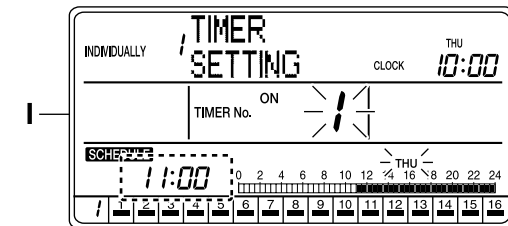

- I. Press the SET/CANCEL button (6) once to apply the setting.

The set time indication changes from blinking to constant On, and the display returns to screen B (blinking Timer No. (7) and "day of the week" indications) shown on page 30.

To set a Timer OFF time continuously, see section D on page 32.

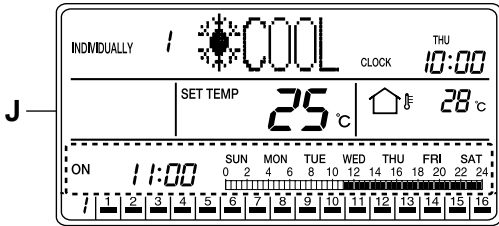

J. If no button is operated for 1 minute or the SCHEDULE button (1) is pressed once, the display returns to the ALL screen when the setting was made in the ALL screen, or to the INDIVIDUALLY screen when the setting was made in the INDIVIDUALLY screen.

If the set time is ahead of the current time, the Schedule setting screen appears.

[Screen Display: Timer OFF Setting]

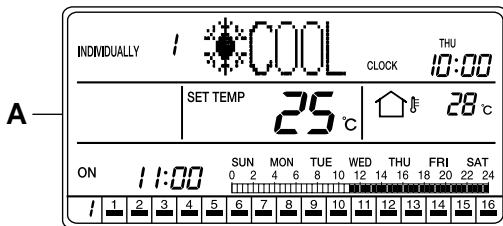

A. While the ALL or INDIVIDUALLY screen is displayed, press the SCHEDULE button (1) once.

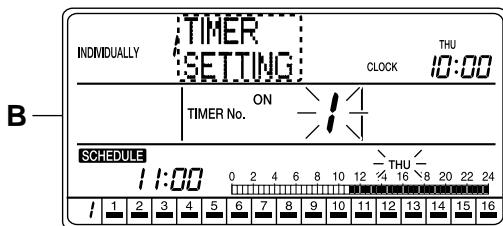

B. The Schedule setting screen appears. If no button is operated for 2 seconds while the display shows screen B on page 32 to screen F on page 32, a guidance message, "△ ▽ BUTTONS: SELECT TIMER No., < > BUTTONS: SELECT DAY OF THE WEEK, SET/CANCEL BUTTON: SET," appears and scrolls in the operation mode display section (dot matrix).

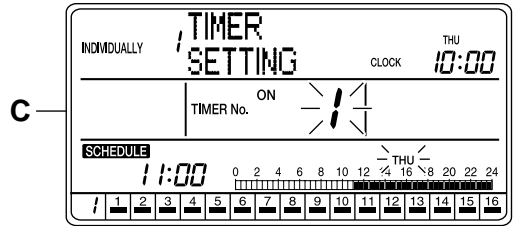

C. Using the ALL button (3) or one of the individual group selection buttons (4) (1 - 16), select the air conditioner (group) to be set.

* If the timer is set in the ALL screen, the setting will apply to all air conditioners (groups).

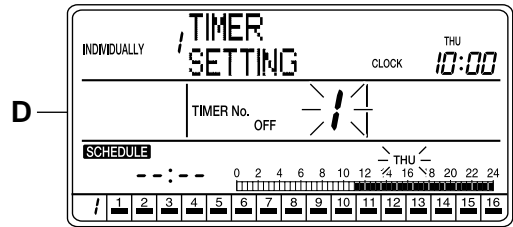

D. Using the △ or ▽ button (2), select TIMER OFF and a Timer No. (7).

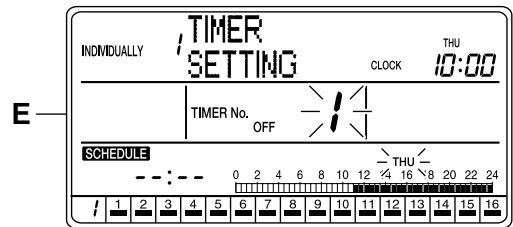
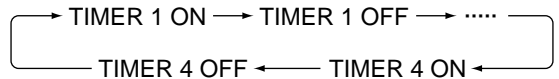

E. Using the < or > button (5), select the day of the week to set.

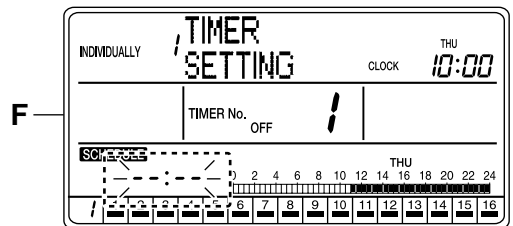
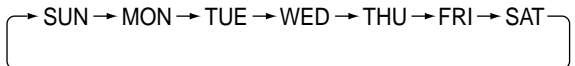

- F. Press the SET/CANCEL button (6) once to apply the setting.
The Timer No. (7) and “day of the week” indications change from blinking to constant On, and the set time indication blinks.

When the SET/CANCEL button (6) is pressed once again, the display returns to screen D (blinking Timer No. (7) and “day of the week” indications) shown on page 32.

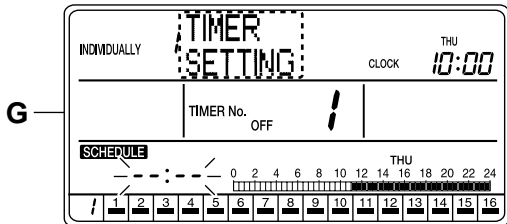

- G. If no button is operated for 2 seconds while the display shows screen G or screen H on page 33, a guidance message, “△ ▽ BUTTONS: CHANGE FUNCTION, ◀ ▶ BUTTONS: SET TIME, SET/CANCEL BUTTON: SET,” appears and scrolls in the operation mode display section (dot matrix).

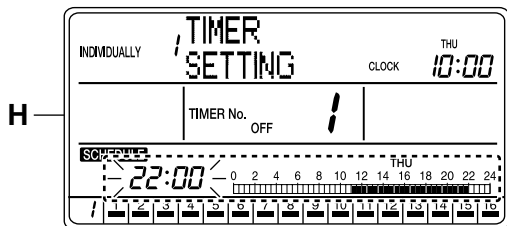

- H. Using the △ or ▽ button (2), select “TIMER SETTING”. (This procedure is not necessary since “TIMER SETTING” was selected in the first step.) Press the ◀ or ▶ button (5) to set time. The blinking set time indication and the schedule bar graph shows the time setting.

* When the button is held pressed, the displayed time changes faster.

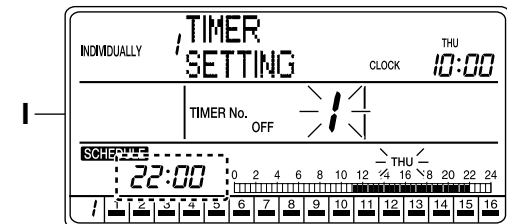

- I. Press the SET/CANCEL button (6) once to apply the setting.
The set time indication changes from blinking to constant On, and the display returns to screen D (blinking Timer No. (7) and “day of the week” indications) shown on page 32.

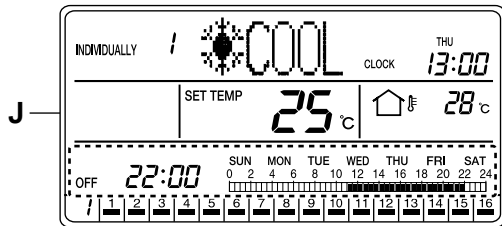

- J. If no button is operated for 1 minute or the SCHEDULE button (1) is pressed once, the display returns to the ALL screen when the setting was made in the ALL screen, or to the INDIVIDUALLY screen when the setting was made in the INDIVIDUALLY screen.
If the set time is ahead of the current time, the Schedule setting screen appears.

SCHEDULE SETTING - “OFF DAY” SETTING

■ Keeping units turned off on a specific day of the week

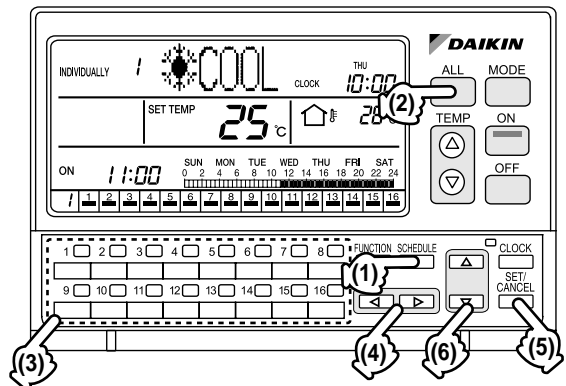

[Operating Procedure]

< “OFF DAY” SETTING >

1. While the ALL or INDIVIDUALLY screen is displayed, press the SCHEDULE button (1) once.
2. The Schedule setting screen appears.
3. Using the ALL button (2) or one of the individual group selection buttons (3) (1 - 16), select the air conditioner (group) to be set.
4. Press the ◀ or ▶ button (4) to set the day of the week for “OFF DAY” SETTING.
5. Press the SET/CANCEL button (5) once to apply the settings.
6. The display changes to the Time setting screen. Using the △ or ▽ button (6), select “OFF DAY”.
7. Press the SET/CANCEL button (5) once to complete the setting procedure.

- If no button is operated for 1 minute or the SCHEDULE button (1) is pressed, the display returns to the ALL screen when the setting was made in the ALL screen, or to the INDIVIDUALLY screen when the setting was made in the INDIVIDUALLY screen.

< “OFF DAY” SETTING Cancellation >

- To cancel the “OFF DAY” SETTING, press the SCHEDULE button (1) once while the ALL screen or INDIVIDUALLY screen is displayed. The display returns to the Schedule setting screen.
 - Press the < or > button (4) to select the day of the week for the cancellation of the “OFF DAY” SETTING.
 - Hold the SET/CANCEL button (5) pressed for more than 4 seconds to cancel the “OFF DAY” SETTING.
- * Schedule setting cannot be made unless the “OFF DAY” SETTING is cancelled.

NOTE

- Operate buttons while the backlights are lit.
- In each of steps 2 through 6, if no button is operated for 1 minute, the display returns to the ALL screen when the setting was made in the ALL screen, or to the INDIVIDUALLY screen when the setting was made in the INDIVIDUALLY screen. In the above-mentioned case, the setting being entered will not be applied.

[Screen Display: “OFF DAY” SETTING]

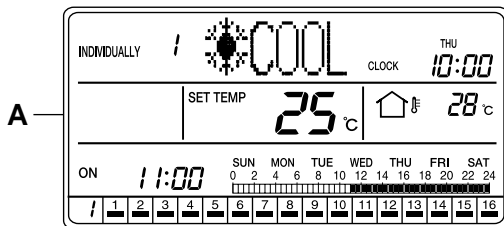

- While the ALL or INDIVIDUALLY screen is displayed, press the SCHEDULE button (1) once.

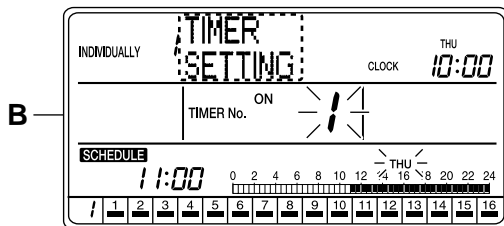

- The Schedule setting screen appears. If no button is operated for 2 seconds while the display shows screen B on page 34 to screen F on page 34, a guidance message, “△ ▽ BUTTONS: SELECT TIMER No., < > BUTTONS: SELECT DAY OF THE WEEK, SET/CANCEL BUTTON: SET,” appears and scrolls in the operation mode display section (dot matrix).

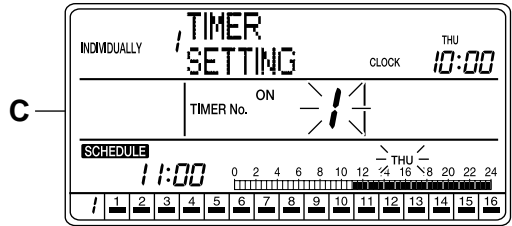

- Using the ALL button (2) or one of the individual group selection buttons (3) (1 - 16), select the air conditioner (group) to be set.

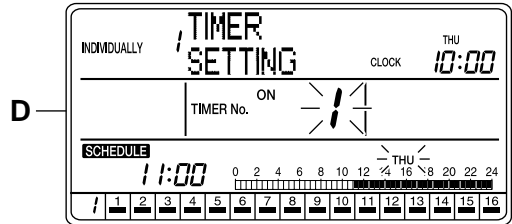

- Press the < or > button (4) to set the day of the week for “OFF DAY” SETTING.

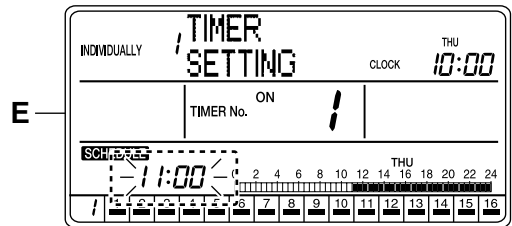

- Press the SET/CANCEL button (5) once to apply the setting. The Timer No. and “day of the week” indications change from blinking to constant On, and the set time indication blinks.

When the SET/CANCEL button (5) is pressed once again, the display returns to screen B (blinking Timer No. (7) and “day of the week” indications) shown on page 34.

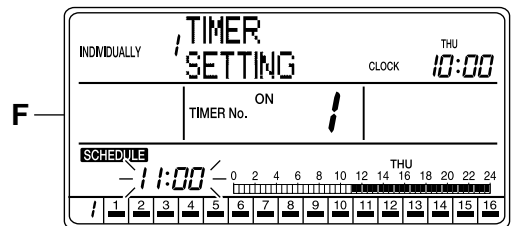

- Using the △ or ▽ button (6), select “OFF DAY” SETTING.

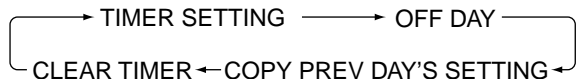

[Screen Display: "OFF DAY" SETTING Cancellation]

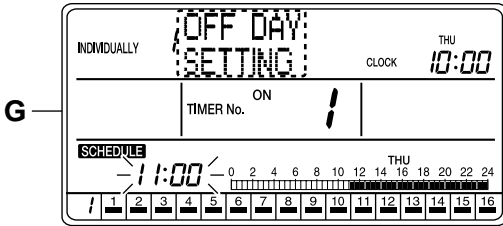

- G. Select "OFF DAY" SETTING, and press the SET/CANCEL button (5) once to apply the setting.

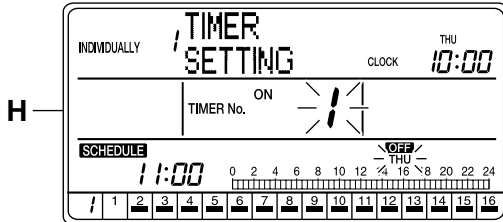

- H. After the "OFF DAY" SETTING is completed, the time indication on the schedule bar graph turns off. The "OFF" mark lights at the specified day of the week.

The set time indication changes from blinking to constant On, and the display returns to screen B (blinking Timer No. and "day of the week" indications) shown on page 34.

* Schedule setting cannot be made for the day for "OFF DAY" SETTING is made, until the "OFF DAY" SETTING is cancelled.

Refer to section C on page 34 for the method of cancelling "OFF DAY" SETTING.

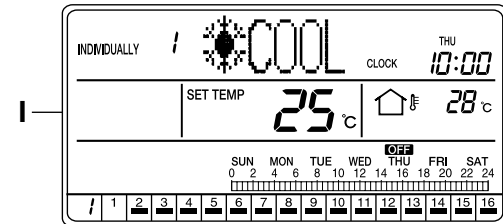

- I. If no button is operated for 1 minute or the SCHEDULE button (1) is pressed once, the display returns to the ALL screen when the setting was made in the ALL screen, or to the INDIVIDUALLY screen when the setting was made in the INDIVIDUALLY screen.

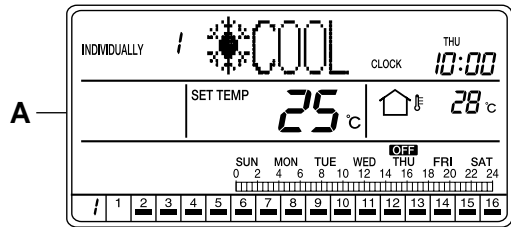

- A. While the ALL or INDIVIDUALLY screen is displayed, press the SCHEDULE button (1) once.

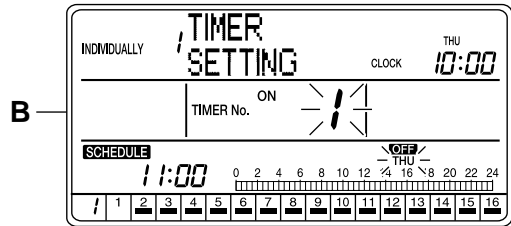

- B. The Schedule setting screen appears. If no button is operated for 2 seconds while the display shows screen B to screen D on page 35, a guidance message, "△ ▽ BUTTONS: SELECT TIMER No., ◀ ▶ BUTTONS: SELECT DAY OF THE WEEK, SET/CANCEL BUTTON: SET," appears and scrolls in the operation mode display section (dot matrix).

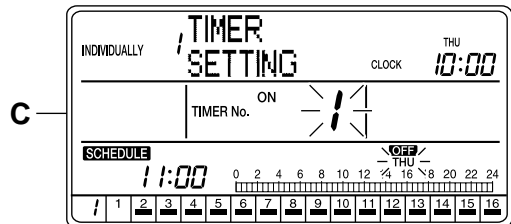

- C. Press the ALL button (2) or one of the individual group selection buttons (3) (1 - 16) to select the air conditioner (group) for which the "OFF DAY" SETTING is to be cancelled.

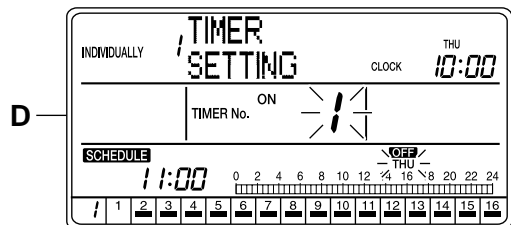

- D. Press the ◀ or ▶ button (4) to select the day of the week for the cancellation of the "OFF DAY" SETTING.

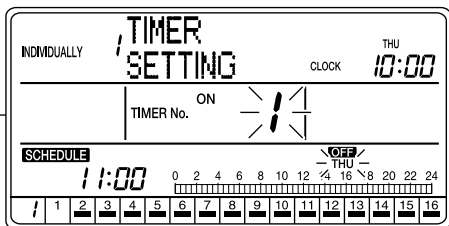

E. Hold the SET/CANCEL button (5) pressed for more than 4 seconds.

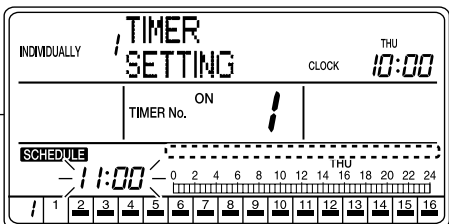

F. The "OFF DAY" SETTING is cancelled and the "OFF" mark turns Off. The set time indication blinks, and a new setting can be entered. The set time indication for the schedule bar graph lights.

If no button is operated for 1 minute or the SCHEDULE button (1) is pressed once, the display returns to the ALL screen when the setting was made in the ALL screen, or to the INDIVIDUALLY screen when the setting was made in the INDIVIDUALLY screen.

SCHEDULE SETTING: COPY PREV DAY'S SETTING

■ Copying the schedule setting of the day before

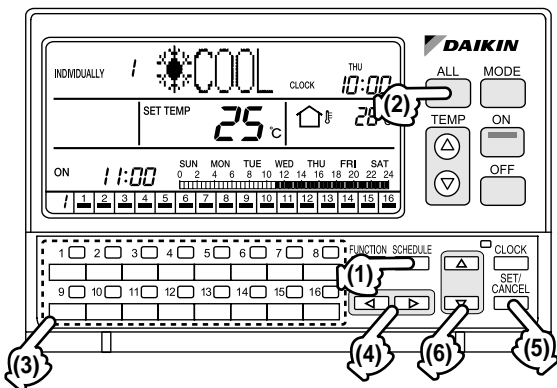

[Operating Procedure]

1. While the ALL or INDIVIDUALLY screen is displayed, press the SCHEDULE button (1) once.
2. The Schedule setting screen appears.

3. Using the ALL button (2) or one of the individual group selection buttons (3) (1 - 16), select the air conditioner (group) to be set.
4. Press the ◀ or ▶ button (4) to select the day of the week to which the setting of the day before is to be copied.

* If "Thursday" is selected, for example, the schedule setting for "Wednesday" will be copied to that day.

5. Press the SET/CANCEL button (5) once to apply the settings.
6. The display changes to the Time setting screen. Using the ▲ or ▼ button (6), select "COPY PREV DAY'S SETTING".
7. Press the SET/CANCEL button (5) once to apply the setting. The schedule setting for the day before the selected day of the week has been copied.
8. If no button is operated for 1 minute or the SCHEDULE button (1) is pressed, the display returns to the ALL screen when the setting was made in the ALL screen, or to the INDIVIDUALLY screen when the setting was made in the INDIVIDUALLY screen.

NOTE

1. Operate buttons while the backlights are lit.
2. In each of steps 2 through 6, if no button is operated for 1 minute, the display returns to the ALL screen when the setting was made in the ALL screen, or to the INDIVIDUALLY screen when the setting was made in the INDIVIDUALLY screen. In the above-mentioned case, the setting being entered will not be applied.

[Screen Display]

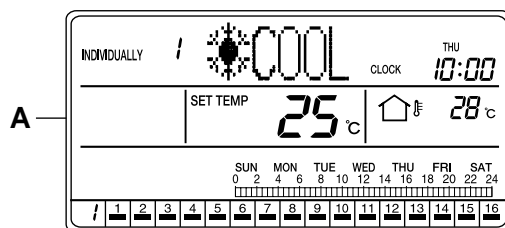

A. While the ALL or INDIVIDUALLY screen is displayed, press the SCHEDULE button (1) once.

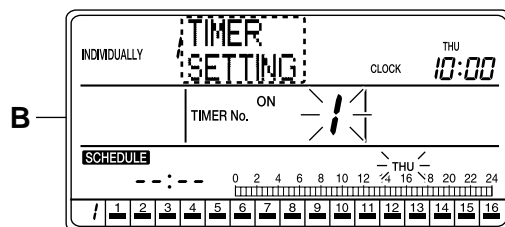

B

- B.** The Schedule setting screen appears.
If no button is operated for 2 seconds while the display shows screen B to screen D on page 36, a guidance message, “△ ▽ BUTTONS: SELECT TIMER No., ◀ ▶ BUTTONS: SELECT DAY OF THE WEEK, SET/CANCEL BUTTON: SET,” appears and scrolls in the operation mode display section (dot matrix).

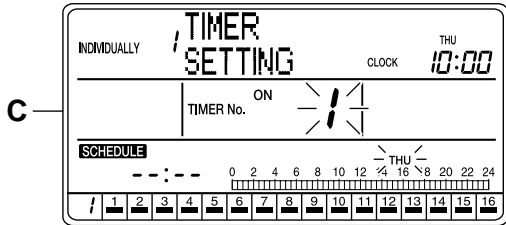

- C.** Using the ALL button (2) or one of the individual group selection buttons (3) (1 - 16), select the air conditioner (group) to be set.

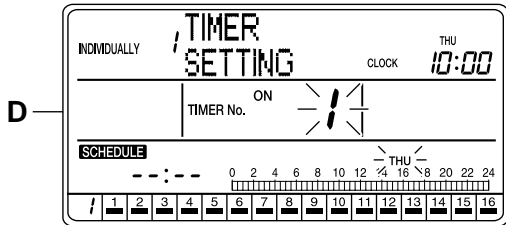

- D.** Press the ◀ or ▶ button (4) to select the day of the week for the “Copy the Day Before” setting.

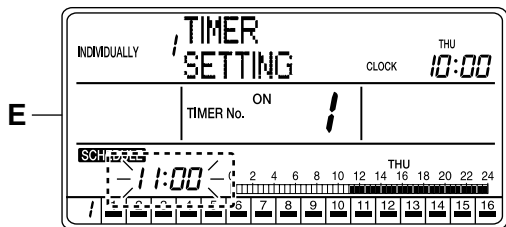

- E.** Press the SET/CANCEL button (5) once to apply the setting.
The Timer No. and “day of the week” indications change from blinking to constant On, and the set time indication blinks.

When the SET/CANCEL button (5) is pressed once again, the display returns to screen B (blinking Timer No. and “day of the week” indications) shown on page 36.

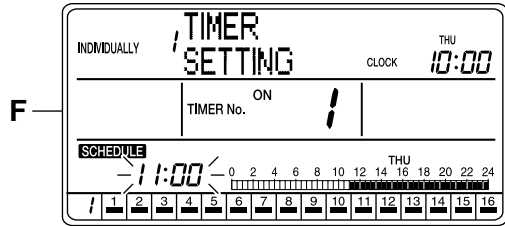

- F.** Press the △ or ▽ button (6) to select “COPY PREV DAY’S SETTING”.

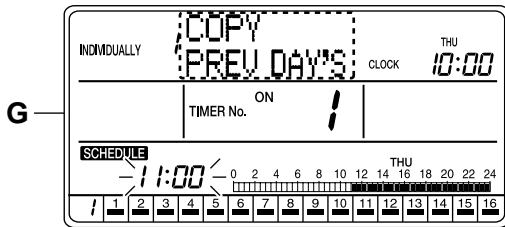
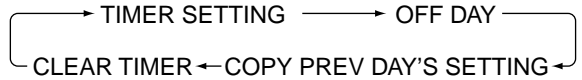

- G.** The above screen appears when “COPY PREV DAY’S SETTING” is selected with the △ or ▽ button (6).

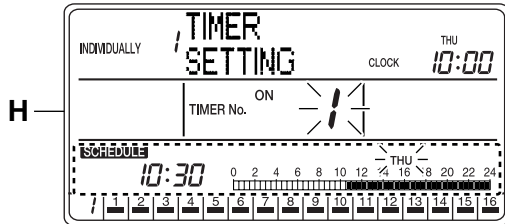

- H.** Press the SET/CANCEL button (5) once to apply the setting.
The schedule setting for the day before the selected day of the week is copied to the selected day of the week.
The set time indication changes from blinking to constant On, and the display returns to screen B (blinking Timer No. and “day of the week” indications) shown on page 36.

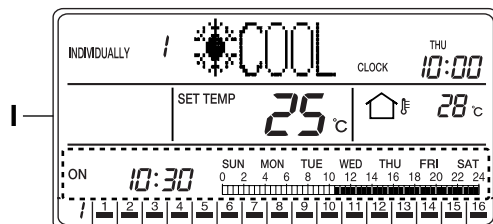

- I. If no button is operated for 1 minute or the SCHEDULE button (1) is pressed once, the display returns to the ALL screen when the setting was made in the ALL screen, or to the INDIVIDUALLY screen when the setting was made in the INDIVIDUALLY screen.

If the setting copied by the above operation is for an operation to be activated after the current time, it is displayed on the Schedule screen.

SCHEDULE SETTING: CLEAR TIMER

■ Clearing ON/OFF setting to "--:--"

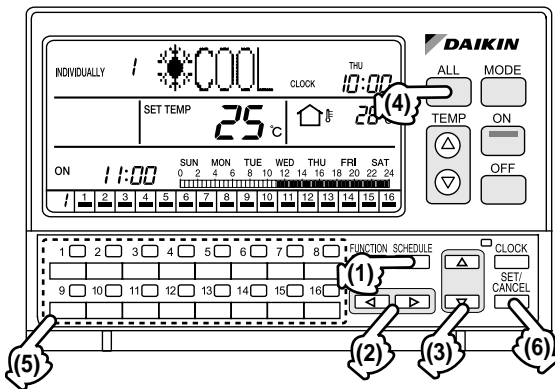

[Operating Procedure]

1. While the ALL or INDIVIDUALLY screen is displayed, press the SCHEDULE button (1) once.
2. The Schedule setting screen appears.
3. Press the ALL button (4) or one of the individual group selection buttons (5) (1 - 16) to select an air conditioner (group) for which the timer is to be cleared.
4. Press the ◀ or ▶ button (2) to select the day of the week for the clearing of timer setting.
5. Using the Δ or ▽ button (3), select the Timer No. to be cleared.

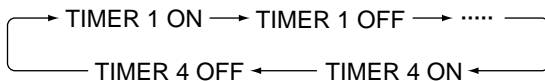

6. Press the SET/CANCEL button (6) once to apply the settings.
7. The Time setting screen appears. Using the Δ or ▽ button (3), select "CLEAR TIMER".
8. Press the SET/CANCEL button (6) once to complete the setting procedure.

9. If no button is operated for 1 minute or the SCHEDULE button (1) is pressed, the display returns to the ALL screen when the setting was made in the ALL screen, or to the INDIVIDUALLY screen when the setting was made in the INDIVIDUALLY screen.

NOTE

1. Operate buttons while the backlights are lit.
2. In each of steps 2 through 7, if no button is operated for 1 minute, the display returns to the ALL screen when the setting was made in the ALL screen, or to the INDIVIDUALLY screen when the setting was made in the INDIVIDUALLY screen. In the above-mentioned case, the setting being entered will not be applied.

[Screen Display]

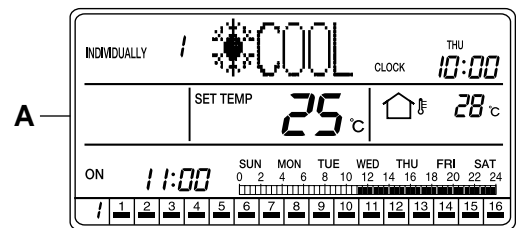

- A. While the ALL or INDIVIDUALLY screen is displayed, press the SCHEDULE button (1) once.

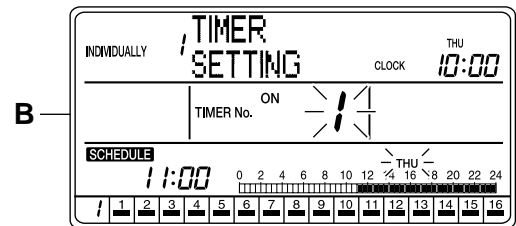

- B. The Schedule setting screen appears. If no button is operated for 2 seconds while the display shows screen B to screen E on page 38, a guidance message, "Δ ▽ BUTTONS: SELECT TIMER No., ◀ ▶ BUTTONS: SELECT DAY OF THE WEEK, SET/CANCEL BUTTON: SET," appears and scrolls in the operation mode display section (dot matrix).

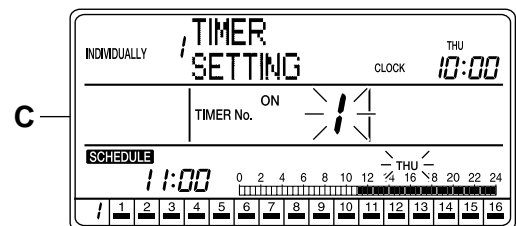

- C. Press the ALL button (4) or one of the individual group selection buttons (5) (1 - 16) to select an air conditioner (group) for which the schedule setting is to be cleared.

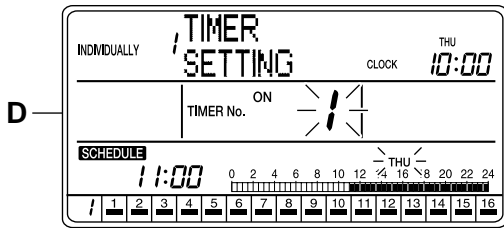

D. Using the ◀ or ▶ button (2), select the day of the week for which the schedule setting is to be cleared.

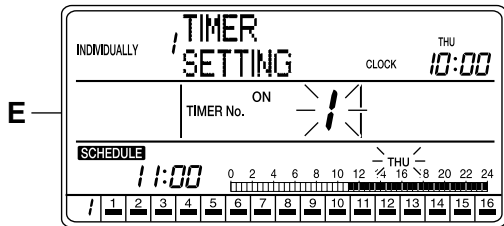

E. Using the ▲ or ▼ button (3), select TIMER ON or TIMER OFF and a Timer No. to be cleared.

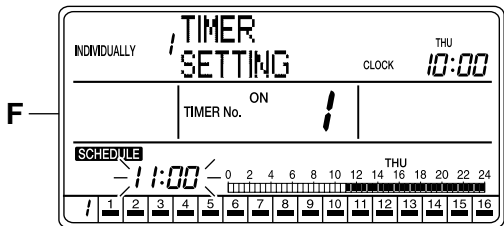
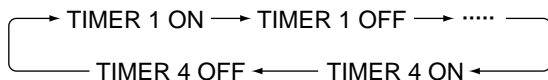

F. Press the SET/CANCEL button (6) once to apply the setting.

The Timer No. and “day of the week” indications change from blinking to constant On, and the set time indication blinks.

When the SET/CANCEL button (6) is pressed once again, the display returns to screen B (blinking Timer No. and “day of the week” indications) shown on page 38.

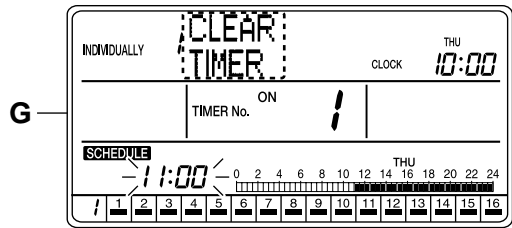

G. Press the ▲ or ▼ button (3) to select CLEAR TIMER.

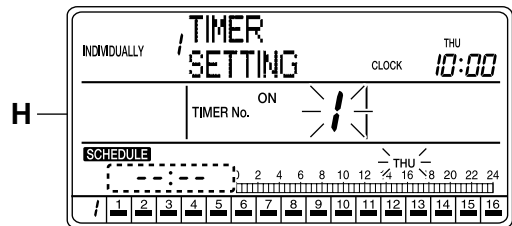
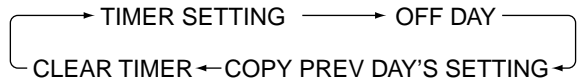

H. Press the SET/CANCEL button (6) once to apply the setting.

The setting is cleared and the setting indication changes to “- - - -”.

The set time indication changes from blinking to constant On, and the display returns to screen B (blinking Timer No. and “day of the week” indications) shown on page 38.

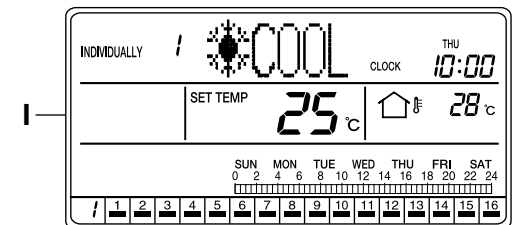

I. If no button is operated for 1 minute or the SCHEDULE button (1) is pressed once, the display returns to the ALL screen when the setting was made in the ALL screen, or to the INDIVIDUALLY screen when the setting was made in the INDIVIDUALLY screen.

CURRENT TIME SETTING

■ Setting the current day of the week and the current time

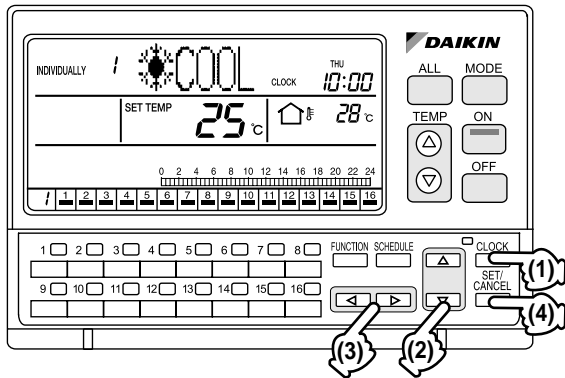

[Operating Procedure]

1. Press the CLOCK button (1) once while the ALL screen or INDIVIDUALLY screen is displayed.
2. The Time setting screen appears.
3. Press the Δ or ∇ button (2) to select an item to set.

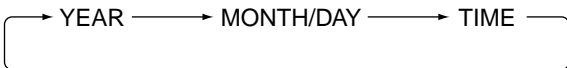

4. While the setting screen is display, make a setting with the < or > button (3).
5. Press the SET/CANCEL button (4) once to complete the setting procedure. (After the setting is completed, the display returns to the operation screen shown prior to the setting procedure.)
6. If no button is operated for 1 minute or the CLOCK button (1) is pressed, the display returns to the ALL screen when the setting was made in the ALL screen, or to the INDIVIDUALLY screen when the setting was made in the INDIVIDUALLY screen.

NOTE

1. Operate buttons while the backlights are lit.
2. In each of steps 2 through 4, if no button is operated for 1 minute, the display returns to the ALL screen when the setting was made in the ALL screen, or to the INDIVIDUALLY screen when the setting was made in the INDIVIDUALLY screen. In the above-mentioned case, the setting being entered will not be applied.

[Screen Display]

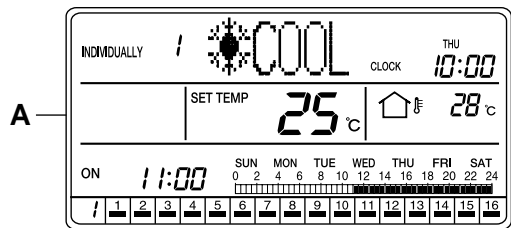

- A. While the ALL or INDIVIDUALLY screen is displayed, press the CLOCK button (1) once.

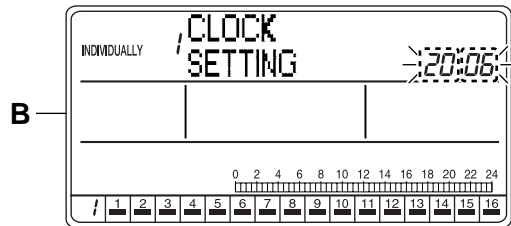

- B. The Setting Time screen appears. The display shows “CLOCK SETTING” for 2 seconds, and then indicates “YEAR”.

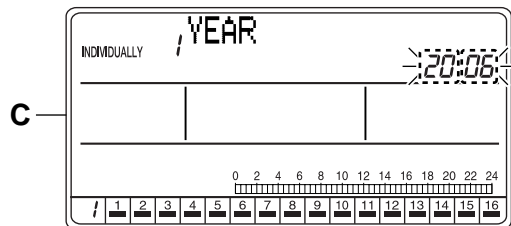

- C. The “YEAR” setting screen appears. If no button is operated for 2 seconds while the display shows screen C on page 40 to screen I on page 41, a guidance message, “Δ ∇ BUTTONS: SET Y/M/D AND TIME, < > BUTTONS: SET TIME, SET/CANCEL BUTTON: SET,” appears and scrolls in the operation mode display section (dot matrix).

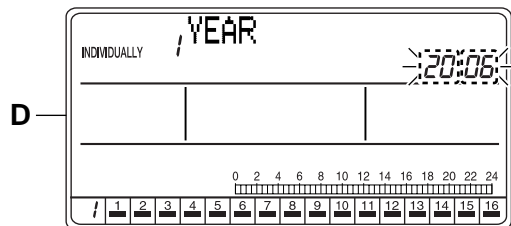

- D. When the Δ or ∇ button (2) is pressed, the setting item changes. Select an item to set.



- * This manual describes the methods of setting 1. YEAR, 2. MONTH/DAY and 3. TIME in that order.

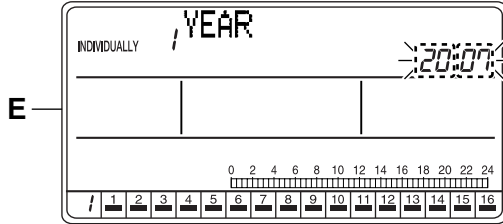

- E. While the "YEAR" setting screen is displayed, set Year by using the \triangleleft or \triangleright button (3). Pressing the \triangleright button increments the year indication. Pressing the \triangleleft button decrements the indication.

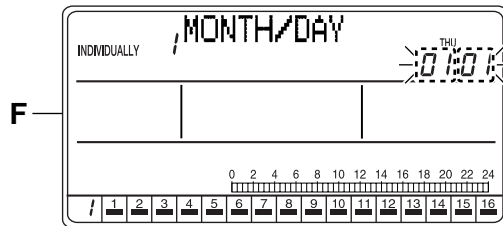

- F. Press the Δ or ∇ button (2) to select "MONTH/DAY".

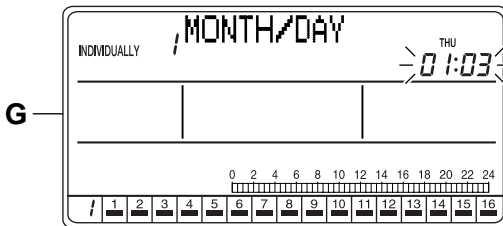

- G. Pressing the \triangleright button (3) increments the month/day indication. Pressing the \triangleleft button decrements the indication.

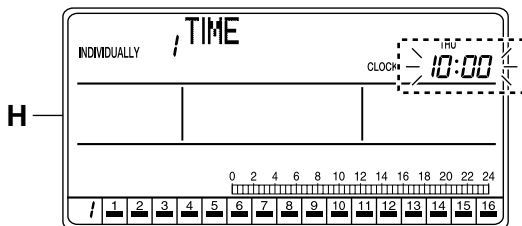

- H. Press the Δ or ∇ button (2) to select "TIME".

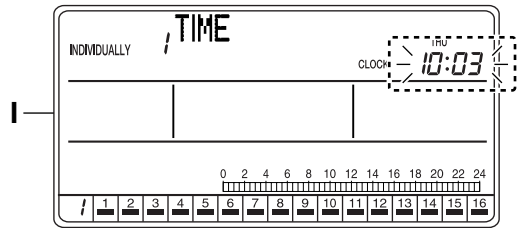

- I. Pressing the \triangleright button (3) increments the time indication. Pressing the \triangleleft button decrements the indication.

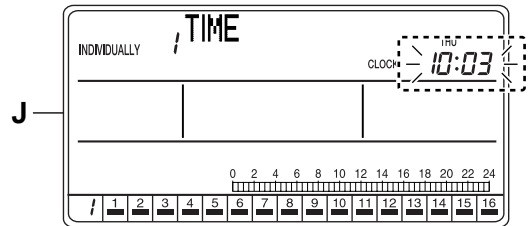

- J. Press the SET/CANCEL button (4) once. The settings will be applied. This completes the setting procedure.

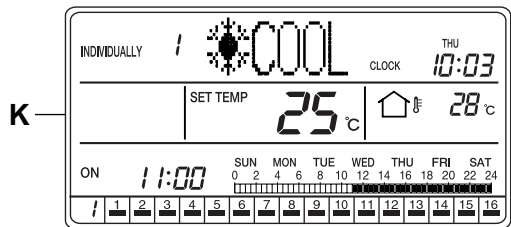

- K. The set time is displayed in the ALL screen if the settings were made in the ALL screen, or in the INDIVIDUALLY screen when the settings were made in the INDIVIDUALLY screen.

STANDBY MODE

- Turning Off the LCD and activating the energy-saving mode

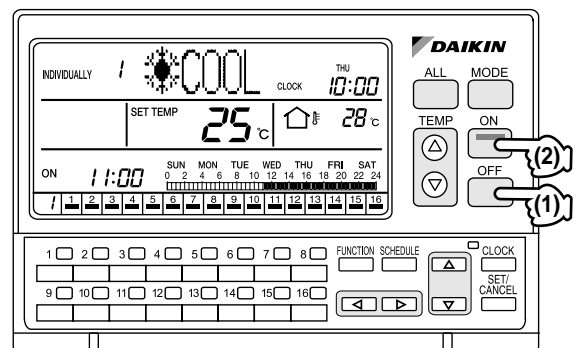

[Operating Procedure]

1. Hold the OFF button (1) pressed for more than 10 seconds while the ALL screen or INDIVIDUALLY screen is displayed.
2. The LCD turns Off and the standby mode (energy-saving mode) will be activated. While in the standby mode, the ON and other buttons are inoperable.
3. Holding the ON button (2) pressed for more than 5 seconds cancels the standby mode (energy-saving mode), and the LCD turns back On.

[Screen Display]

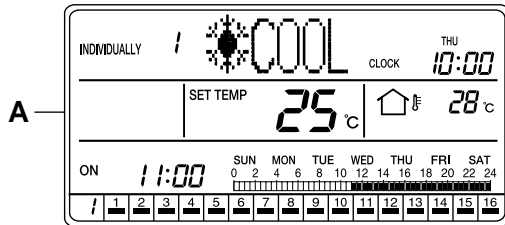

- A. Hold the OFF button (1) pressed for more than 10 seconds while the ALL screen or INDIVIDUALLY screen is displayed.

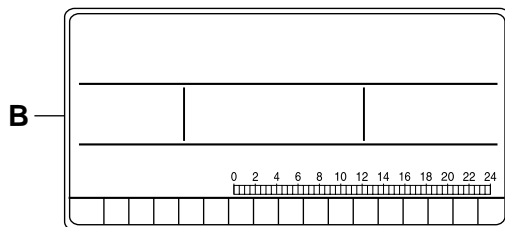

- B. The LCD turns Off and the standby mode (energy-saving mode) will be activated. While in the standby mode, the ON and other buttons are inoperable.

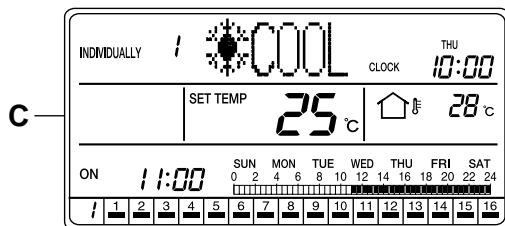

- C. Holding the ON button (2) pressed for more than 5 seconds cancels the standby mode (energy-saving mode), and the LCD turns back On.

OUTDOOR TEMPERATURE DISPLAY

■ Displaying the outside temperature detected by the outdoor unit connected to an air conditioner

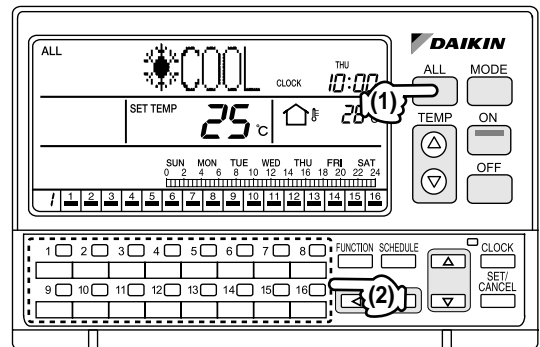

[Operating Procedure]

1. When the ALL button (1) is pressed, the display shows the outdoor temperature detected by the outdoor unit connected to the air conditioner (group) with a cooling/heating selection privilege (*) that has the smallest unit No. (* An air conditioner (group) with a cooling/heating selection privilege is a unit which allows switching of the operation mode between cooling and heating.)
2. When an air conditioner (group) is selected by pressing one of the individual group selection buttons (2) (1 - 16), the display shows the outdoor temperature detected by the outdoor unit connected to the selected air conditioner (group).

[Screen Display]

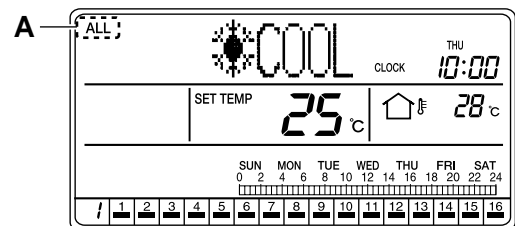

- A. Press the ALL button (1) or one of the individual group selection buttons (2) (1 - 16) to select an air conditioner (group) for the display of the outdoor temperature.

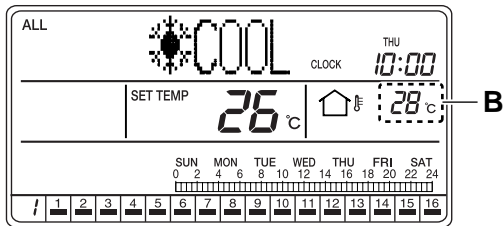

- B.** In the case of the ALL screen, the display shows the outdoor temperature detected by the outdoor unit connected to the air conditioner (group) with a cooling/heating selection privilege (*) that has the smallest unit No.

In the case of the INDIVIDUALLY screen, the display shows the outdoor temperature detected by the outdoor unit connected to the selected air conditioner (group).

(* An air conditioner (group) with a cooling/heating selection privilege is a unit which allows switching of the operation mode between cooling and heating.)

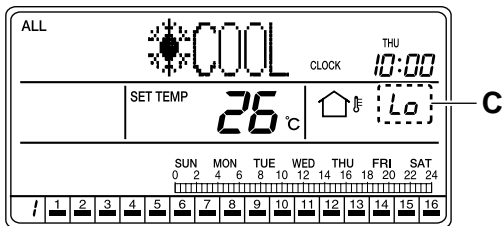

- C.** During cooling operation, the “Lo” indication appears if the outdoor temperature falls below 10°C while the room temperature is higher than the set temperature.

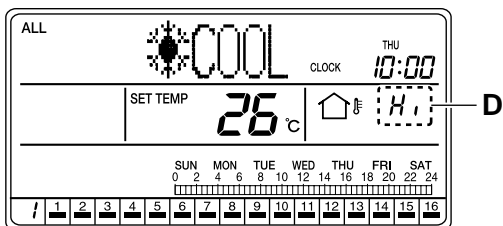

- D.** During cooling operation, the “Hi,” indication appears if the outdoor temperature becomes higher than 39°C while the room temperature is higher than the set temperature.

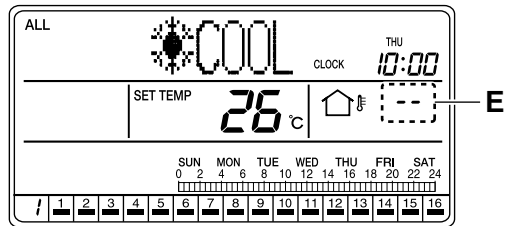

- E.** During cooling operation, if the room temperature is lower than the set temperature, the outdoor temperature display remains fixed for 30 minutes, and it changes to “-”.

When the cooling operation is turned off, the outdoor temperature display that was shown prior to OFF remains fixed for 30 minutes, and the temperature display changes to “-”.

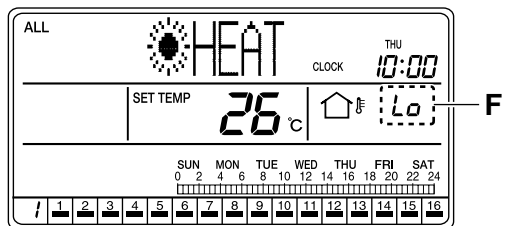

- F.** During heating operation, the “Lo” indication appears if the outdoor temperature falls below -9°C while the room temperature is lower than the set temperature.

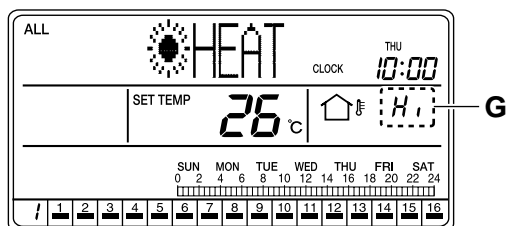

- G.** During heating operation, the “Hi,” indication appears if the outdoor temperature becomes higher than 39°C while the room temperature is lower than the set temperature.

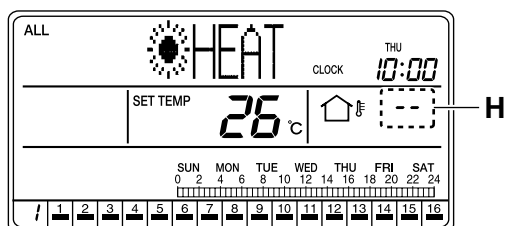

- H. During heating operation, if the room temperature is higher than the set temperature, the outdoor temperature display remains fixed for 30 minutes, and the temperature display changes to “- -”. When the cooling operation is turned off, the outdoor temperature display that was shown prior to OFF remains fixed for 30 minutes, and it changes to “- -”.

ERROR DIAGNOSTIC FUNCTION

- This function notifies an error generated in an air conditioner

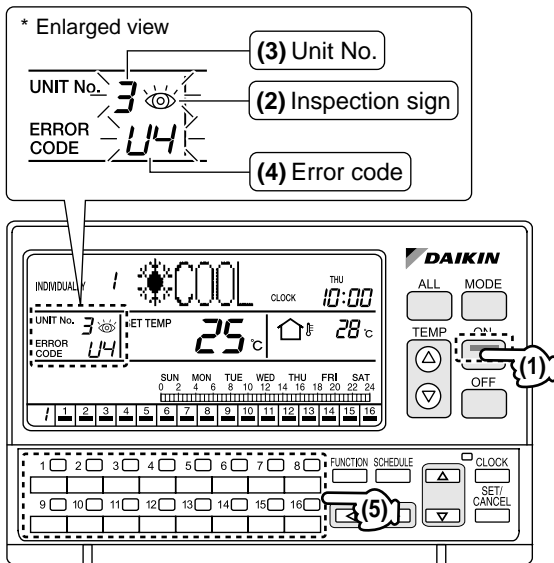

[About the Error Diagnosis Function]

The Central Remote Controller is equipped with a diagnostic function that analyzes the cause of an error resulting in operation shutdown. In the event of protection device activation, open-circuit occurs in the control communication cable, or malfunctioning of parts, the ON lamp (1), inspection sign (2) and Unit No. (3) blink, and an error code (4) will be displayed. Also, in the operation monitor section, the ■ indication blinks under the air conditioner (group) that has shut down due to an error. Since this information helps locate the cause of the problem, check the displayed information and contact your dealer.

[Operating Procedure]

1. While the ALL or INDIVIDUALLY screen is displayed, press one of the individual group selection buttons (5) (1 - 16) to select the air conditioner (group) that shut down due to an error.
2. The screen shows the Unit No. (3) of the air conditioner (group) that shut down due to an error, and an error code (4) lights.

* For the details of error codes, refer to pages 44 and 47.

NOTE

Operate buttons while the backlights are lit.

[Details of Error Codes]

Operation lamp	Maintenance display	Unit No.	Malfunction code	Error content
☀	●	🔦	64	Indoor air thermistor error
☀	●	🔦	65	Outdoor air thermistor error
☀	●	🔦	68	HVU error (Ventiair dust-collecting unit)
☀	●	🔦	6A	Dumper system error
🔦	🔦	🔦	6A	Dumper system error + Thermistor error
☀	●	🔦	6F	Simple remote controller error
☀	●	🔦	6H	Door switch (Ventiair dust-collecting unit), relay harness fault (Ventiair dust-collecting/humidifier unit)
🔦	🔦	🔦	94	Ventiair internal transmission error (between total enthalpy – fan unit)
🔦	🔦	🔦	A0	Indoor unit · external safety device error
🔦	🔦	🔦	A1	Indoor unit · BEV unit (Sky-Air connection unit) PC board assembly fault
☀	●	🔦	A1	Indoor unit · PC board assembly fault

☼	☼	☼	A3	Indoor unit · Drain level error (33H)
☼	☼	☼	A6	Indoor unit · Fan motor (51F) lock, overload
☼	●	☼	A7	Indoor unit · Fan direction adjustment motor (MA) error
☼	☼	☼	A7	Indoor unit · Fan direction adjustment motor error
☼	☼	☼	A9	Indoor unit · BEV unit, electric expansion valve motor (20E) error
☼	●	☼	AF	Indoor unit · Malfunctioning drain
☼	●	☼	AH	Indoor unit · Dust-collector error
☼	☼	☼	AJ	Indoor unit · Insufficient capacity setting, address setting fault
☼	☼	☼	C4	Indoor unit · Liquid piping thermistor (Th2) Error (faulty connection, cut wire, short circuit, fault)
☼	☼	☼	C5	Indoor unit · BEV unit, gas piping thermistor (Th3) Error (faulty connection, cut wire, short circuit, fault)
☼	☼	☼	C9	Indoor unit · Intake air thermistor (Th1) Error (faulty connection, cut wire, short circuit, fault)
☼	☼	☼	CA	Indoor unit · Outlet air thermistor (Th4) Error (faulty connection, cut wire, short circuit, fault)
☼	●	☼	CJ	Indoor unit · remote controller sensor error
☼	☼	☼	E0	Outdoor unit · Safety device operation
☼	☼	☼	E1	Outdoor unit · PC board assembly fault
☼	●	☼	E1	Outdoor unit · PC board assembly fault
☼	☼	☼	E3	Outdoor unit · High-pressure switch fault
☼	☼	☼	E4	Outdoor unit · Low-pressure switch fault
☼	☼	☼	E5	Outdoor unit · Inverter compressor lock
☼	☼	☼	E6	Outdoor unit · Constant-speed compressor motor overcurrent/lock
☼	☼	☼	E7	Outdoor unit · Fan motor lock
☼	☼	☼	E9	Outdoor unit · Electric expansion valve motor (20E) error
☼	●	☼	EC	Heat source unit · Intake water temperature inter-lock operation (fan operation)
☼	☼	☼	EF	Outdoor unit · Ice thermal storage unit error
☼	☼	☼	F3	Outdoor unit · Discharge piping temperature error
☼	☼	☼	F6	Outdoor unit · Refrigerant overcharge
☼	●	☼	H3	Outdoor unit · High-pressure switch operation
☼	☼	☼	H4	Outdoor unit · Low-pressure switch operation
☼	☼	☼	H7	Outdoor unit · Fan motor sensor error
☼	☼	☼	H9	Outdoor unit · Outdoor air thermistor (Th1) Error (faulty connection, cut wire, short circuit, fault)
☼	●	☼	H9	Outdoor unit · Outdoor air thermistor (Th1) Error (faulty connection, cut wire, short circuit, fault)
☼	●	☼	HC	Outdoor unit · Water temperature sensor system error
☼	●	☼	HF	Ice thermal storage unit error, ice thermal storage controller error, error in outdoor unit during ice thermal storage operation
☼	●	☼	HJ	Outdoor unit · water system fault
☼	☼	☼	J1	Outdoor unit · pressure sensor error
☼	☼	☼	J2	Outdoor unit · Compressor current sensor error
☼	☼	☼	J3	Outdoor unit · Discharge piping thermistor (Th3) Error (faulty connection, cut wire, short circuit, fault)
☼	●	☼	J3	Outdoor unit · Discharge piping thermistor (Th3) Error (faulty connection, cut wire, short circuit, fault)
☼	☼	☼	J4	Outdoor unit · Heat exchanger gas pipe thermistor error
☼	☼	☼	J5	Outdoor unit · Intake piping thermistor (Th4) Error (faulty connection, cut wire, short circuit, fault)
☼	☼	☼	J6	Outdoor unit · Heat exchange thermistor (Th2) error

☀	●	⦿	J6	Outdoor unit · Heat exchange thermistor (Th2) error Error (faulty connection, cut wire, short circuit, fault)
⦿	⦿	⦿	J7	Outdoor unit · Header thermistor (Th6) error
⦿	⦿	⦿	J8	Outdoor unit · Oil pressure equalizer thermistor error (faulty connection, cut wire, short circuit, fault)
⦿	⦿	⦿	J9	Outdoor unit · Double-pipe heat exchanger outlet thermistor error (faulty connection, cut wire, short circuit, fault)
⦿	⦿	⦿	JA	Outdoor unit · Discharge piping pressure sensor error
⦿	⦿	⦿	JC	Outdoor unit · Intake piping pressure sensor error
⦿	⦿	⦿	JF	Outdoor unit · Oil temperature sensor (Th5) system error
☀	●	⦿	JH	Outdoor unit · Oil temperature sensor (Th5) system error
⦿	⦿	⦿	L0	Outdoor unit · Inverter system fault
⦿	⦿	⦿	L4	Outdoor unit · Inverter cooler fault
⦿	⦿	⦿	L5	Outdoor unit · Ground circuit for compressor motor, short circuit, or power unit short circuit
⦿	⦿	⦿	L6	Outdoor unit · Ground circuit for compressor motor, short circuit
⦿	⦿	⦿	L8	Outdoor unit · Compressor overload, compressor motor wire disconnection
⦿	⦿	⦿	L9	Outdoor unit · Compressor lock
⦿	⦿	⦿	LA	Outdoor unit · Power unit error
⦿	⦿	⦿	LC	Outdoor unit · Transmission error between inverter and outdoor control unit
☀ or ●	⦿	⦿	M1	Central controller: PC board fault
☀ or ●	⦿	⦿	M8	Transmission error between central controllers
☀ or ●	⦿	⦿	MA	Central controller: Incorrect combination
☀ or ●	⦿	⦿	MC	Central controller: Address setting fault
⦿	●	⦿	P0	Insufficient gas (thermal storage)
⦿	⦿	⦿	P1	Outdoor unit · Power voltage imbalance, phase loss
⦿	⦿	⦿	P4	Outdoor unit · Power unit temperature sensor error
⦿	⦿	⦿	PJ	Outdoor unit · Faulty combination of control PCB ASSY and inverter or fan
☀	●	⦿	U0	Pressure drop due to insufficient refrigerant, electric expansion valve fault, etc.
⦿	⦿	⦿	U1	Reversed or lost phase
⦿	⦿	⦿	U2	Power voltage error, momentary electrical stoppage
⦿	⦿	⦿	U3	Outdoor unit · Commissioning not executed
⦿	⦿	⦿	U4	Transmission error between indoor unit/BEV unit and outdoor/BS unit, Transmission error between outdoor unit and BS unit
⦿	⦿	⦿	U5	Transmission error between remote controller and indoor control unit
●	⦿	●	U5	Remote controller board fault or remote controller setting fault
⦿	⦿	⦿	U6	Transmission error between indoor units
⦿	⦿	⦿	U7	Transmission error between outdoor units Transmission error between outdoor unit and ice thermal storage unit
☀	●	⦿	U7	Transmission error between outdoor units (cooling/heating batch, low-noise operation)
●	⦿	●	U8	Transmission error between master remote controller and slave remote controller (slave remote controller error) Incorrect combination of indoor unit and remote controller within a single system (model)
⦿	⦿	⦿	U9	Transmission error between indoor unit/BEV unit and outdoor unit within a single system Transmission error between BS unit and indoor unit/BEV unit and outdoor unit within a single system

☀	☀	☀	UA	Incorrect combination of indoor, BS, and outdoor units within a single system (model, number of units, etc.) Incorrect combination of indoor unit and remote controller (remote controller in question) BS unit connection position fault
☀	☀	☀	UC	Central control group numbers overlap
☀	☀	☀	UE	Transmission error between indoor unit and central controller
☀	☀	☀	UF	Unset system, incorrect settings between BEV unit and indoor unit
☀	☀	☀	UH	System fault

■ error codes (in outline font) do not display “maintenance” and the system will run, but please check the content of the display and contact your dealer.

COOLING/HEATING PRIVILEGE SETTING

■ Enabling the switching of the operation mode between cooling and heating

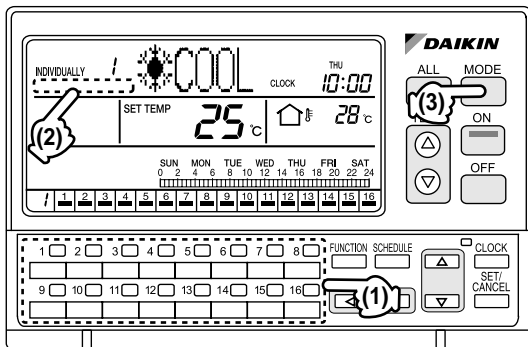

- The “MASTER CONTROLLED” indication (2) blinks for all air conditioners (groups) that are connected to the outdoor unit to which the selected air conditioner (group) is connected.

* When the system is turned On for the first time, the “MASTER CONTROLLED” indication (2) blinks for all air conditioners (groups).

- Using one of the individual group selection buttons (1) (1 - 16), select an air conditioner (group) to which the selection privilege is to be set. Then, press the MODE button (3).

The operation mode selection privilege is set, and the “MASTER CONTROLLED” indication (2) turns Off.

For other air conditioners (groups), the “MASTER CONTROLLED” indication (2) lights.

NOTE

Operate buttons while the backlights are lit.

[About Cooling/Heating Privilege]

If two or more air conditioners (groups) with ON remote controllers are connected to an outdoor unit whose operation mode such as cooling, heating and ventilation can be set from an ON remote controller or the Central Remote Controllers, it is necessary to set the operation mode selection privilege to one of those air conditioners (groups).

[Operating Procedure]

- While the ALL screen or INDIVIDUALLY screen is displayed, press one of the individual group selection buttons (1) (1 - 16) and select an air condition without the “MASTER CONTROLLED” indication (2).
- Hold the MODE button (3) pressed for more than 4 seconds.
- The “MASTER CONTROLLED” indication (2) blinks.

[Screen Display]

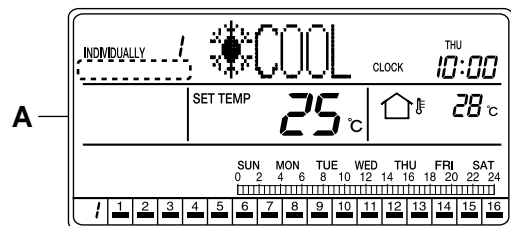

- While the ALL screen or INDIVIDUALLY screen is displayed, press one of the individual group selection buttons (1) (1 - 16) and select an air condition without the “MASTER CONTROLLED” indication (2).

SPECIFICATIONS

■ Specifications

Power supply	50/60Hz, 200V - 240V
Power consumption	Max. 3W
Forced OFF input	Continuous a contact Contact current: approx. 10 mA
Size	180 (W) × 122 (H) × 63 (D)
Weight	530g

■ External View

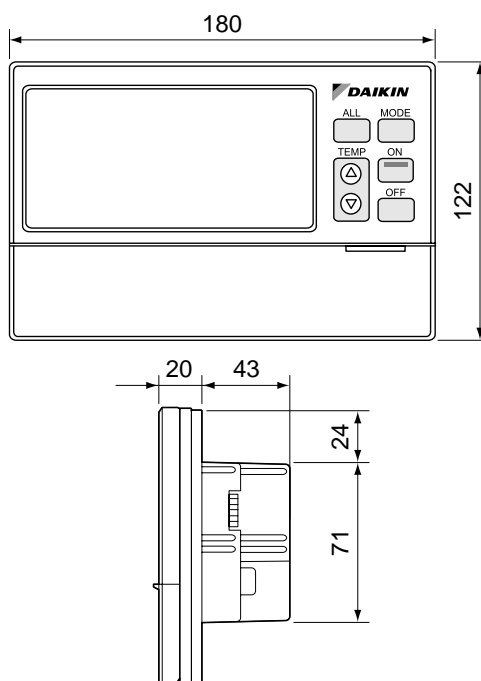

The specifications and external appearance of the product are subject to change without prior notice due to improvement.

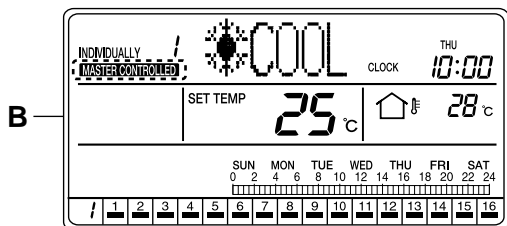

- B. Hold the MODE button (3) pressed for more than 4 seconds.
The “MASTER CONTROLLED” indication (2) blinks.

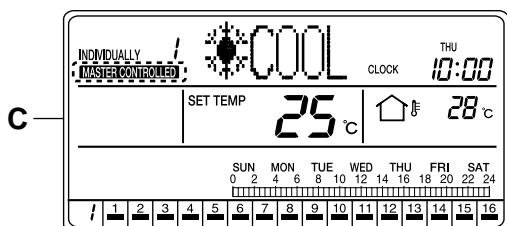

- C. The “MASTER CONTROLLED” indication (2) blinks for all air conditioners (groups) that are connected to the outdoor unit to which the selected air conditioner (group) is connected.

* When the system is turned On for the first time, the “MASTER CONTROLLED” indication (2) blinks for all air conditioners (groups).

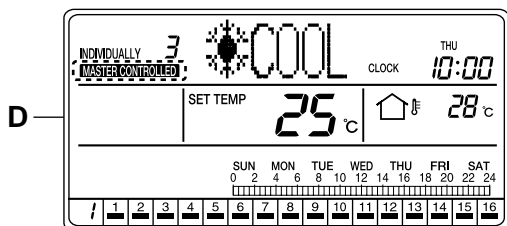

- D. Using one of the individual group selection buttons (1) (1 - 16), select an air conditioner (group) to be set with a cooling/heating selection privilege.

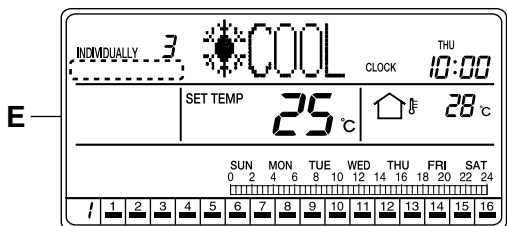

- E. After selecting the air conditioner (group) to be set with a cooling/heating selection privilege, pressed the MODE button (3).

The operation mode selection privilege is set, and the “MASTER CONTROLLED” indication (2) turns Off.

For other air conditioners (groups), the “MASTER CONTROLLED” indication (2) lights.

AFTER-SALE SERVICE

■ About After-sale Service

WARNING

Do not attempt to disassemble, modify or repair the product.

Electrical shock or fire may result if you attempt to disassemble, modify or repair the product yourself.

Request your dealer when the product needs repair.



Prohibit

Do not relocate the product from the original installation place yourself.

Improper installation can result in water leaks, electrical shock or fire.

Request your dealer when the product needs to be relocated.



Prohibit

- **When requesting repair, provide the following information:**

- Model name
- Date of installation
- Description of malfunction
Provide as much detail as possible.
(Also describe the indications displayed on the remote control.)
- Your name, address and phone number

- **Relocation of the product**

Relocation of the product must be performed by a trained specialist. If the product needs to be relocated, be sure to contact your dealer.
There will be a charge for the relocation of the product.

- **Repair after the expiration of warranty (free-repair period)**

If the product exhibits a problem after the warranty expires, consult your dealer. If the product function can be restored by repair, we will repair the product for a charge upon receiving your repair request.
(Warranty period: One full year from the date of installation)

- **Inquiries regarding repair service**

For further information regarding after-sale service, contact your dealer.

DAIKIN INDUSTRIES, LTD.

Head office:

Umeda Center Bldg., 2-4-12, Nakazaki-Nishi,
Kita-ku, Osaka, 530-8323 Japan

Tokyo office:

JR Shinagawa East Bldg., 2-18-1, Konan,
Minato-ku, Tokyo, 108-0075 Japan

DAIKIN EUROPE NV

Zandvoordestraat 300, B-8400 Oostende, Belgium