



WALL MOUNTED AIR CONDITIONER

OWNER'S MANUAL



This manual applies to models:

QHF025
QHF036
QHF050
QHF060
QHF065
QHF080

When using this air conditioner in the European countries, the following guidance must be followed:

DISPOSAL: Do not dispose this product as unsorted municipal waste. Collection of such waste separately for special treatment is necessary.

It is prohibited to dispose of this appliance in domestic household waste.

For disposal, there are several possibilities:

- 1 The municipality has established collection systems, where electronic waste can be disposed of at least free of charge to the user.
- 2 When buying a new product, the retailer will take back the old product at least free of charge.
- 3 The manufacture will take back the old appliance for disposal at least free of charge to the user.
- 4 As old products contain valuable resources, they can be sold to scrap metal dealers.

Wild disposal of waste in forests and landscapes endangers your health when hazardous substances leak into the ground-water and find their way into the food chain.

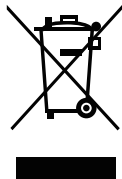

CONTENT

1. READ BEFORE OPERATING

1.1 Safety Precautions	03
1.2 Part Names	06

2. OPERATION

2.1 Operating Conditions	07
2.2 Manual Operation	07
2.3 Directional Control	08
2.4 How it Works	09
2.5 Special Functions	10

3. CARE

Care and Maintenance	12
----------------------------	----

4. TROUBLE SHOOTING

Guides, Tips and Cautions	15
---------------------------------	----



- Read this manual before using the product!
- Children or persons with reduced physical, sensory or mental capabilities may only use this appliance under direct supervision.
- ELECTRICAL work such as power cable or switch replacement, may only be performed by authorized personnel and in accordance with national wiring standards.

READ BEFORE OPERATION

1.1 Safety Precautions

- Follow these instructions carefully to;
 - avoid incorrect operation,
 - prevent personal injury or consequential damage
 - optimise product life
- The level of seriousness is classified as follows:



WARNING

This symbol indicates the possibility of personnel injury or loss of life.



CAUTION

This symbol indicates the possibility of property damage or serious onsequences.

- Symbols used in this manual:



AVOID



COMPLY

WARNING



The task of installing this product must only be performed by suitably qualified and appropriately experienced persons.

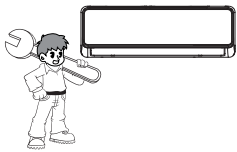

Power plug must be securely inserted into the socket outlet if applicable

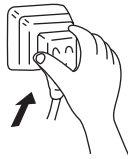

Do not operate or stop the unit by connecting or disconnecting power plug

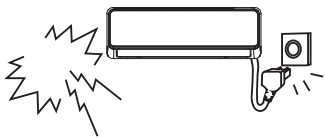

Do not use extension cord or share the same power outlet with other appliances

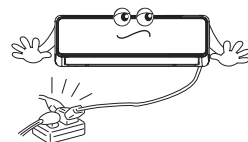

Do not use flammable gas or ombustibles such as gasoline, benzene, thinner, etc. in the conditioned space.

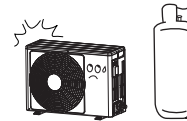

Do not use a heating appliance in the conditioned space.

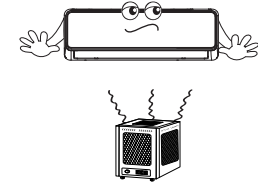

Children must be advised not to play with the air conditioner controls, moving parts and/or refrigeration and electrical connections.

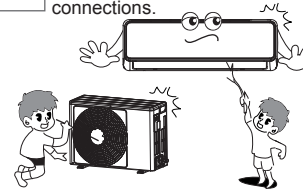

Prolonged exposure to drafts may lead to muscular discomfort and dry eyes

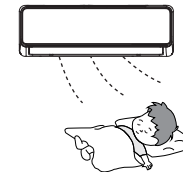

Operating with wet hands may result in electrical shock

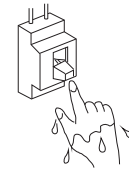

Turn off the unit if unusual smells, sounds or vibrations are noticed. Contact authorized dealer.

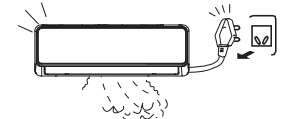

Do not attempt to repair, move or modify your air conditioner.

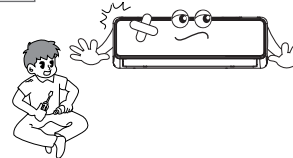

Seek professional help – contact an authorized dealer.

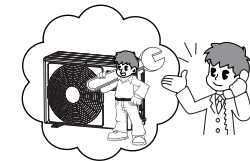

READ BEFORE OPERATION

CAUTION

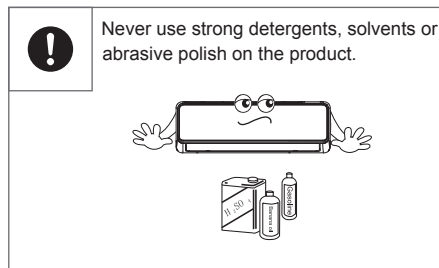
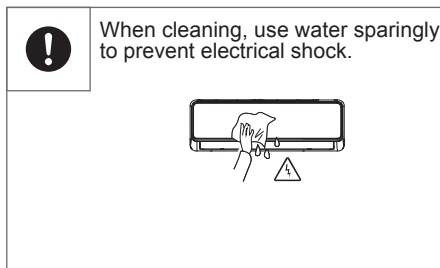
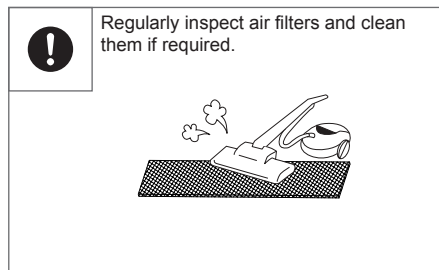
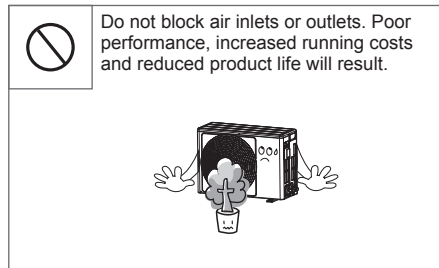
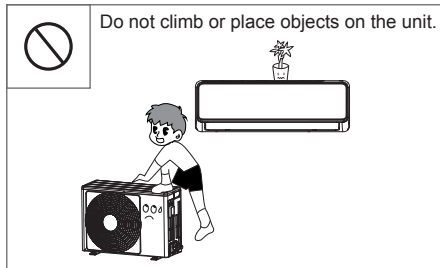
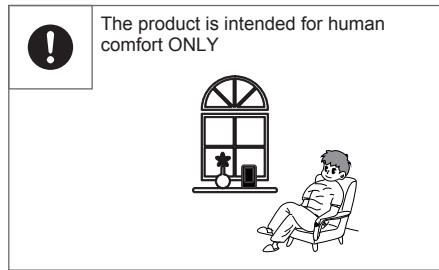
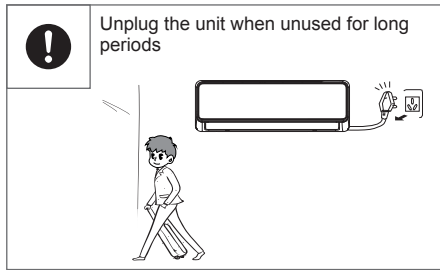

1.2 Part Names

■ Indoor

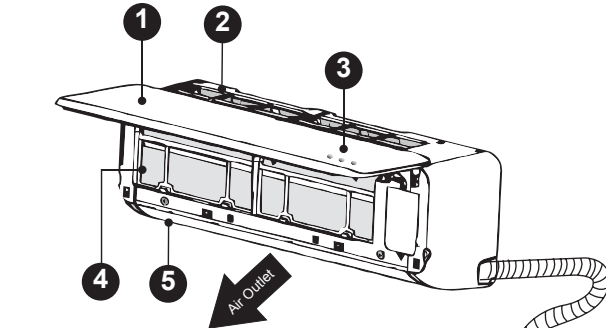



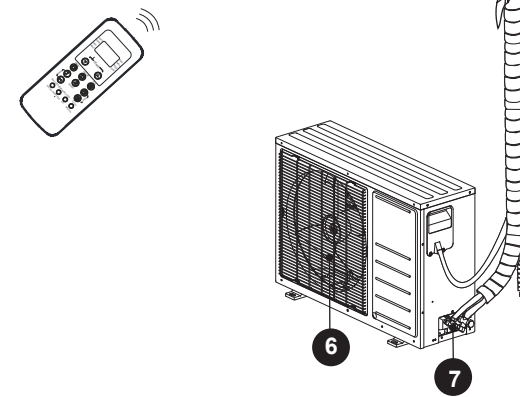

1. Front Panel
2. Air Inlet
3. Display
4. Air Filter
5. Louver
6. Grille
7. Service valve

■ Outdoor

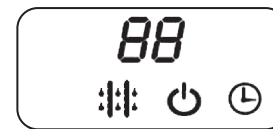

■ Display symbols



-  OPERATION
-  TIMER PERIOD SELECTION
-  PREHEAT OR DEFROST IN PROGRESS
-  SELECTED TEMPERATURE SELF-DIAGNOSTIC CODES

Note: A guide on using the infrared remote controller is included in this literature package.

2.1 Operating temperature

		Indoor	Outdoor
Cooling operation	Upper limit	32°C DB	46°C DB
	Lower limit	18°C DB	-10°C DB
Heating operation	Upper limit	27°C DB	24°C DB
	Lower limit	0°C DB	-15°C DB

Note: DB - Dry Bulb

- Optimum performance will be achieved within these operating temperatures.
- When the unit operates above or below these conditions for a long time, system diagnostics may detect a malfunction and the unit will not operate properly.
- Room relative humidity - less than 80%. If the air conditioner operates outside this range, the surface of the air conditioner may attract condensation. Please set the air flow louver to its maximum angle and set HIGH fan mode.

2.2 Manual Operation

Manual operation is available to control the unit when your remote is unavailable.

ACCESS

Open the front panel by carefully lifting both ends at the same time. Once lifted sufficiently, a click is heard and it becomes self-supporting.

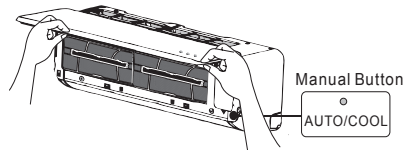

OPERATE

Press the manual button repeatedly to change modes as follows;
 a Once = AUTO mode [heat, cool or fan 24°C and auto fan speed].
 b Twice=COOLING mode [switches to AUTO mode after 30 minutes (mainly used for testing purpose)].
 c Three times = OFF.

COMPLETE

Close the panel by firmly tugging downwards on both ends until it returns to its original position.

RESTORE

Using the remote controller will return the unit to normal operation.

2.3 How It Works!

Basic Operation Modes: AUTO / COOL / DRY / HEAT / FAN

AUTO Mode

- In this setting the system will automatically change modes and fan speed to the set temperature.
- [In spring and autumn, closer temperature control may require COOL/HEAT mode changes.]

DRY Mode

In this mode, priority is given to dehumidifying the air. Low fan speed and compressor cycling is used to achieve this and regulate room temperature.

SLEEP Mode

When selected, the set temperature will increase (cooling) or decrease (heating) by 1°C per hour for the first 2 hours. Thereafter it keeps this new temperature for 5 hours before switching off.

This operation saves energy and improves night time comfort by synchronising with the body's metabolism.

Hints For Economical Operation

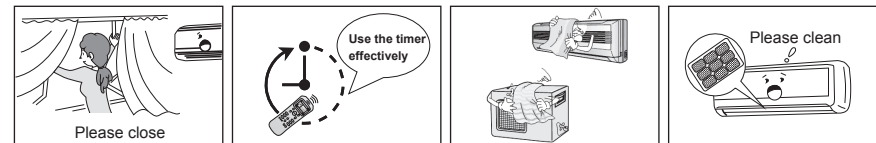
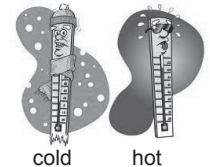

- Adjust the temperature to achieve moderate comfort levels.
- Excessively low or high temperatures waste energy.
- Improve performance by keeping windows and doors closed.
- Limit energy usage [run time] by using the TIMER function.



- Do not block air inlets or outlets. Poor performance, increased running costs and reduced product life will result.
- Inspect the air filters periodically, and clean them when needed.

2.4 Directional Control

Adjusting vertical air flow

- Press “SWING  ” on remote controller to adjust vertical air flow direction. The louver position moves slightly each time the button is pressed.
- Press “SWING  ” to engage continuous louver motion.

Note: Please refer to the REMOTE CONTROLLER MANUAL for details

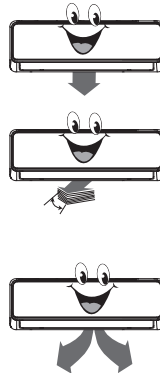

Adjusting horizontal air flow

Step 1

ISOLATE the unit at the MAIN switch (or unplug)

Step 2

Pull horizontal louver downwards using both hands.

Step 3

Identify the lever/s as indicated.

[On uppermost part of air outlet and linked to recessed vertical blades].

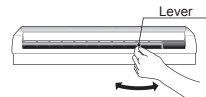
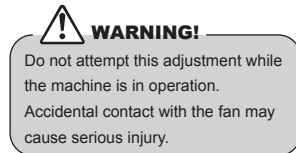

Step 4

Move the lever/s left or right to guide the air in the desired direction.

Step 5

ENERGISE the unit at the MAIN switch!

(or plug back in)

NOTE: Isolating the main power supply synchronises the horizontal louver.



LOUVER POSITION

Maximum down

In COOLING or DRY mode, condensate may form and drip from unit in high humidity condition.

Narrow opening

Restricted air flow reduces performance and may cause condensate.

Closed

Do not operate if it will not open – damage may occur.

LOUVER ACTION

After a quick restart, louver may remain static for ±10s.

2.5 Special Functions

■ Compressor Delay

At start-up, a time delay of 3 to 4 minutes protects the compressor.

■ Cold Draft Prevention

To avoid uncomfortable drafts in heating mode, the indoor unit is preheated before the fan starts. This delay should only last a few minutes.

■ Auto Defrost

Ice develops on the outdoor unit in heating mode. To defrost this ice, the indoor fan stops for a few minutes before heating continues.

■ Auto Restart

The unit will automatically restart after a power interruption.

Previous user settings are all recovered.

■ Auto Leak Detection

When refrigerant leakage is detected, the unit will display “EC” code or flash LEDs [model dependent].

■ Mildew Prevention

This function keeps the indoor fan running in low speed for 7 – 10 minutes after being turned off by the user in cooling mode. Drying the water droplets on the indoor heat exchanger prevents mildew growth.

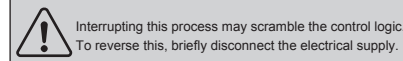

■ Louver Memory

Horizontal louver angle is memorised and will return to the position last selected by the user. This will not happen when turbo or manual control buttons are pressed or after a power interruption.

■ Turbo

Turbo function enables the unit to reach the preset temperature at cooling or heating operation in the shortest time.

■ Silence

When silence function is activated, the compressor will operate at low frequency and the indoor unit will bring faint breeze, which will reduce the noise to the lowest level and make a quiet and comfortable feeling for sleep.

■ Self Cleaning

Airborne bacteria use the moisture on the indoor heat exchanger to grow. Regular drying of the exchanger prevents this growth. By simply pressing the “self clean” button, the controller will automatically manage the process.

Cooling only units

Only the indoor fan is active in low speed for 30 minutes and the unit turns off.

Heating & Cooling units [Heat pumps]

Only the indoor fan is active in low speed for 13 minutes. Heating is activated for 1minute then fan only for 1minute and finally it turns off.

This cleaning action may be done as frequently as desired.

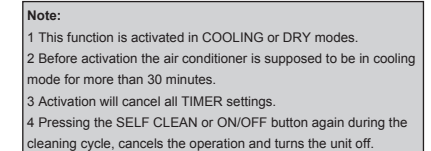

Care and Maintenance

DISCONNECT from power source
BEFORE attempting to clean or service!

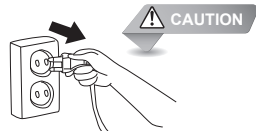

Filter Cleaning

1 Open the front panel by carefully lifting both ends at the same time.
At a certain angle, a clicking sound is heard and it becomes self-supporting.

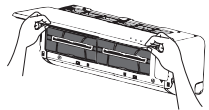

3 Unclip the small specialised filter.

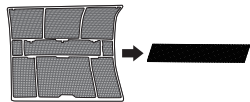

5 Vacuum clean the small filter/s.
[Replace occasionally]



7 Re-insert into unit in the reverse order described in point 2 above.



General Cleaning

Use a soft damp cloth when cleaning the grille, casing and remote controller.



- No chemicals e.g. detergents, solvents, abrasive polish, etc,
- No heat (over 40 °C)

2 Hold the tab on the filter to move it up a little, then pull slightly towards you .
Now extract the filter by gently pulling it downwards.



4 Clean the large air filter/s with soapy water. Rinse with fresh water. Shake off excess water.

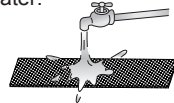

6 Refit the small filter onto the large filter.

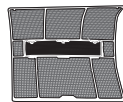

8 Close the front panel.



Storage Preparation [long idle periods]

- 1) Clean the air filters
- 2) In humid or damp climates, operate in Fan only mode until the unit has dried out.
- 3) Turn the air conditioner off with the remote and remove the batteries.
- 4) Disconnect from the power source.

Re-use After Storage

- 1) Reconnect to the power source
- 2) Wait 24 hours when the ambient temperature is low.
- 3) Reinstall the batteries into the remote controller and turn the unit on.

Preventative Maintenance

Regularly check your unit for:

1. Obstructed airflow through the indoor and outdoor units.
2. Water or oil leaks.
3. Damaged or disconnected wires



Metal parts may have sharp edges that cause injury. Take care!

Regular high level maintenance of the indoor and outdoor units is essential.

- Specialist MAINTENANCE is required to do deep-clean, lubricate and function check of all critical components.
- Do not attempt such work by yourself.
- Contact a suitable service provider.

TROUBLE SHOOTING

Guides, Tips and Cautions

The following may occur during normal operation, and may not indicate malfunction.

Case	Explanation
Cooling or heating is delayed.	A 3 minute delay protects the compressor.
Fan speed changes – off , very slow and then normal	Automatically happens in heating mode - prevents cold air blowing onto occupants.
The heating operation stops suddenly and defrost-light blinks.	Frost removal on outdoor unit is in progress (5 – 10mins).
Mist coming out of the indoor unit	May occur when unit temperature is low and room air is hot and humid.
Low volume sounds are emitted by the air conditioner	"Hissing": normal – gas pressure equalizing when compressor stops or starts.
	"Squeaking": normal expansion and contraction of plastic and metal parts.
	Rushing air – normal when louver resets its position.
Dust discharges from the unit.	May occur when air conditioner is used for the first time or has not been used for a long time.
Emits a peculiar odour.	Usually caused by chemicals, cigarette smoke, cooking etc. If not the case call your suitable contractor.
Changes to fan only while cooling or heating.	Room temperature is the same as that selected with the remote. If not the case call a suitable contractor.
Poor heating performance	May occur when outdoor temperatures are close to or below zero degrees Celsius.
	If not the case call a suitable contractor.
Turns on automatically	Normal when power is restored after a power failure.
Operation is erratic, unpredictable or unresponsive.	Interference from cell phone towers and remote boosters may cause the unit to malfunction.
	Disconnect the power and then re-connect.
	Press the ON/OFF button on the remote controller to restart operation.
	If the problem is not resolved call a suitable contractor.

CONCERN	PLEASE FIRST CHECK!
Unit will not operate.	• Is there a power failure?
	• Has a switch been turned off, a circuit breaker tripped or a fuse blown?
	• Are the batteries in the remoter control fresh?
	• Are the clock and timer on the remote set correctly?
Not cool/warm enough.	• Are the temperature and mode settings correct?
	• Are the air filters clean?
	• Are the windows and doors closed?
	• Is air flow unrestricted in & out of indoor & outdoor units?
	• Is fan speed on high and louvers allowing maximum flow?

UNIT NOT RESPONDING AS REQUIRED?

- Record the product's model number,
- Contact a suitable contractor,
- Share all observed details!



In the case of ANY of the following, turn off the unit immediately!

- Power cord is damaged or abnormally warm.
- Burning odours are smelled.
- Loud or abnormal sounds are heard.
- A power fuse blows or a circuit breaker trips frequently.
- Water or other objects fall into or out of the unit.
- Indicators blink continuously.
- A self-diagnostic code is displayed e.g. E0, E1, E2 ... or P0, P1, P2... etc.

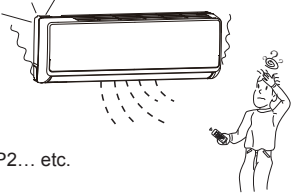

**DO NOT ATTEMPT TO CORRECT THESE ITEMS YOURSELF!
CONTACT A SPECIALIST SERVICE PROVIDER!**